

# PATIO HEATER OWNER'S MANUAL

FOR MODELS:  
HLS01-CGT



Batch #  
**HLS01-CGT**

AZ Patio Heater Toll Free Number  
**888-775-1330**



## IMPORTANT

Read this manual carefully before assembling, using or servicing this heater. Keep this manual for future reference.

## Contents

General Safety Information.....	1
Assembly Instructions	
Components & Hardware.....	3&4
Additional Requirements.....	4
Installation Process	
Step 1 - Attach Wheel Assembly to Base.....	4
Step 2 – Attach Bucket to Base.....	4
Step 3–Attach Cylinder Housing to Base.....	5
Step4–Attach Post to Cylinder Housing.....	5
Step 5 – Tabletop Installation.....	5
Step 6 – Attach Reflector Studs to Screen Cover...	5
Step 7 – Attach Head Assembly to Post.....	6
Step 8 – Install Reflector.....	6
Step 9 – Attach Reflector Assembly to Studs.....	7
Step10–Connect Hose & Regulator to Cylinder....	7
Leak Check.....	9
Operation.....	9
Operation Checklist	10
Troubleshooting.....	11
Maintenance.....	11
Storage.....	12
Service.....	12
Warranty .....	12

## General Safety Information

This manual contains important information about the assembly, operation and maintenance of this patio heater. General safety information is presented in these first few pages and is also located throughout the manual.

Keep this manual for future reference and to educate new users of this product. This manual should be read in conjunction with the labeling on the product.

Safety precautions are essential when any mechanical or propane fueled equipment is involved. These precautions are necessary when using, storing, and servicing. Using this equipment with the respect and caution demanded will reduce the possibilities of personal injury or property damage.

The following symbols shown below are used extensively throughout this manual. Always heed these precautions, as they are essential when using any mechanical or fueled equipment.

## DANGER

DANGER indicates an imminently hazardous situation which, if not avoided, will result in death or serious injury.

## WARNING

WARNING indicates an imminently hazardous situation which, if not avoided, could result in death or serious injury.

## CAUTION

CAUTION indicates an imminently hazardous situation which, if not avoided, may result in minor or moderate personal injury, or property damage.

## FOR YOUR SAFETY

Do not store or use gasoline or other flammable vapor and liquids in the vicinity of this or any other appliance.

## WARNING: For Outdoor Use Only

## WARNING

Improper installation, adjustment, alteration, service or maintenance can cause injury or property damage. Read the instructions thoroughly before installing or servicing this equipment.

## DANGER

Failure to comply with the precautions and instructions provided with this heater can result in death, serious bodily injury and property loss or damage from hazards of fire, explosion, burn, asphyxiation, and/or carbon monoxide poisoning.

Only persons who can understand and follow the instructions should use or service this heater.

## DANGER

### • EXPLOSION - FIRE HAZARD

- Keep solid combustibles, such as building materials, paper or cardboard, a safe distance away from the heater as recommended by the instructions.
- Provide adequate clearances around air openings into the combustion chamber.
- Never use the heater in spaces which do or may contain volatile or airborne combustibles, or products such as gasoline, solvents, paint thinner, dust particles or unknown chemicals.
- During operation, this product can be a source of ignition. Keep heater area clear and free from combustible materials, gasoline, paint thinner, cleaning solvents and other flammable vapors and liquids. Do not use heater in areas with high dust content. Minimum heater clearances from combustible materials: three (3) feet from the sides & two (2) feet from the top.

## FOR YOUR SAFETY

If you smell gas:

1. Shut off gas to the appliance.
2. Extinguish open flame.
3. If odor continues, immediately call your gas supplier.

## WARNING

We cannot foresee every use which may be made of our heaters.

Check with your local fire safety authority if you have questions about heater use.

Other standards govern the use of fuel gases and heat producing products for specific uses. Your local authorities can advise you about these.

If no local codes exist, follow National Fuel Gas Code, ANSI Z223.1. In Canada, installation must conform to local codes. If no local codes exist, follow the current National standards of CANADA CAN/CGA-B 149.2.

## DANGER

### • CARBON MONOXIDE HAZARD

- This heater is a combustion appliance. All combustion appliances produce carbon monoxide (CO) during the combustion process. This product is designed to produce extremely minute, non-hazardous amounts of CO if used and maintained in accordance with all warnings and instructions. Do not block air flow into or out of the heater.
- Carbon Monoxide (CO) poisoning produces flu-like symptoms, watery eyes, headaches, dizziness, fatigue and possibly death. You can't see it and you can't smell it. It's an invisible killer. If these symptoms are present during operation of this product get fresh air immediately!
- For outdoor use only .
- Never use inside house, or other unventilated or enclosed areas.
- This heater consumes air (oxygen). Do not use in unventilated or enclosed areas to avoid endangering your life.

## CAUTION

### • SERVICE SAFETY

- Keep all connections and fittings clean. Make sure propane cylinder valve outlet is clean.
- Inspect hose before use. Replace if there is evidence of abrasion or wear.
- During set up, check all connections and fittings for leaks using soapy water. Never use a flame.
- Use as a heating appliance only. Never alter in any way or use with any device.
- Check entire hose at least annually.

## WARNING

### • BURN HAZARD

- Never leave heater unattended when hot or in use.
- Keep out of reach of children.

## ! WARNING

- This product is fueled by propane gas. Propane gas is invisible, odorless, and flammable. An odorant is normally added to help detect leaks and can be described as a “rotten egg” smell. The odorant can fade over time so leaking gas is not always detectable by smell alone.
- Propane gas is heavier than air and leaking propane will sink to the lowest level possible. It can ignite by ignition sources including matches, lighters, sparks or open flames of any kind many feet away from the original leak. Use only propane gas set up for vapor withdrawal.
- Propane gas should be stored or used in compliance with local ordinances and codes or with ANSI/NFPA 58. Turn off propane when not in use.

## ! DANGER

- **EXPLOSION - FIRE HAZARD**
- Never store propane near high heat, open flames, pilot lights, direct sunlight, other ignition sources or where temperatures exceed 120 degrees F (49°C).
- Propane vapors are heavier than air and can accumulate in low places. If you smell gas, leave the area immediately.
- Never install or remove propane cylinder while heater is lighted, near flame, pilot lights, other ignition sources or while heater is hot to touch.
- This heater is red hot during use and can ignite flammables too close to the burner. Keep flammables at least 3 feet from sides & 2 feet from top. Keep gasoline and other flammable liquids and vapors well away from heater.
- The propane cylinder must always be stored outdoors in a well ventilated space. Never store propane cylinder in an enclosed area (house, garage, etc.). If heater is to be stored indoors, disconnect the propane cylinder for outdoor storage.

## Assembly Instructions

### Components

- Remove all components from package.

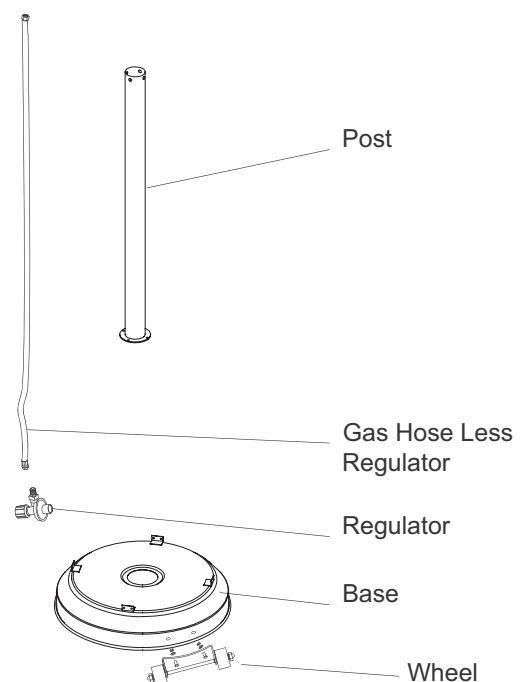
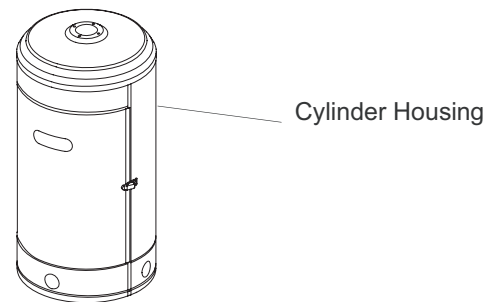
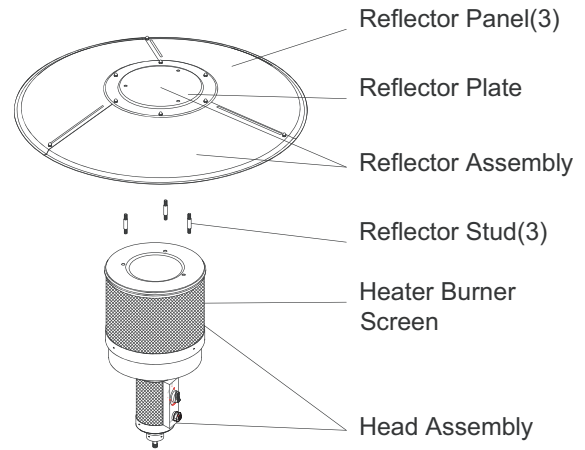













# ⚠ WARNING

## California Proposition 65

Combustion by products produced when using this product contain chemicals known to the state of California to cause cancer, birth defects, and other reproductive harm.

### Hardware

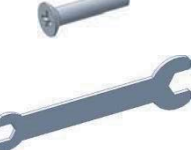
Picture	Qty	Description	Used in Step(s)
	6	Large Bolt	2/3
	4	Large Flat Washer	3
	8	Small Screws	3
	8	Small Nuts	3
	10	Small Bolt	2/4
	6	Large Flat Washer	9
	9	Cap Nut	8
	6	Large Nuts	2
	9	Small Screw	8
	3	Wing Nut	9
	10	Flange Nuts	2/4
	3	Reflector Stud	6
	4	Large Screws	2
	1	Wrench	1 / 3 / 4 / 7 / 8

### Additional Requirements

The following items are not included, but are necessary for the proper assembly of your heater. Do NOT attempt to assemble without proper tools.

- Philips screwdriver w/ medium blade.
- Adjustable opening wrench.
- Leak Detection Solution (Instructions on how to make solution are included in step )

Note: You must follow all steps to properly assemble heater.

## Installation process Assembly time: 0.5 hour

(For models without Wheels , skip to Step 2)

### Step 1 – Attach Wheel Assembly to Base

- Line up holes in Wheel Bracket with corresponding holes in base, insert 2 large bolts through holes and finger tighten 2 Large Nuts.
- Be sure that the Wheel Assembly is parallel to the base, and fully tighten bolts

Wheel Assembly



2 Req'd Large Bolts



2 Req'd Large Nuts



(For models without Bucket , skip to Step 3)

### Step 2 – Attach Bucket to Base



- Slide 4 Large screws through holes of Base.
- Slide 4 Large nuts through holes under bucket . and tighten screws with phillips screw driver.



4 Req'd Large Screws



4 Req'd Large Nuts

- Fill bucket with sand



- Optional ground fixtures for surface mounting. Not for use in conjunction with wheels. (Not available with all models)
- Mount optional ground fixtures with 6 pcs small bolts and flange nuts into holes on base housing.

### Step 3 – Attach Cylinder Housing to Base

- Attach I-shaped brackets to base housing loosely with 4pcs M8 X M10 large bolts and large flat washers.
- Attach cylinder to housing to base with 8 small phillips screws and 8 small nuts. Tighten all hardware from this step.



### Step 4 – Attach Post to Cylinder Housing top

- Open the door, put post through the hole on the top of Cylinder Housing.



- Attach post to Cylinder Housing using 4pcs small bolts into Flange nuts from inside tank housing.

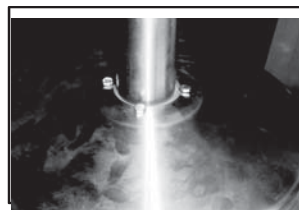

(For models without tabletop, skip to Step 6)

### Step 5 – Tabletop Installation

- Put the Plastic nut & Fastening piece through the post in order. Put the Tabletop through the post as show.



- Put the Plastic connecting through the post as show.



- Through the Fastening piece to the hole on the Tabletop. Hold the tabletop using a hand and screw the Fastening piece to the Plastic connecting counter-clockwise using the other one. Fasten the Fastening piece. Screw the Plastic nut to the Plastic connecting counter-clockwise. Fasten the Plastic nut.
- Adjust the height of the Tabletop. Loose the Plastic nut and adjust the Tabletop height of you want. Fasten the Plastic nut.



### Step 6 – Attach Reflector Studs to Screen Cover

- Insert 3 Reflector Studs
- Tighten studs securely.

3 Req'd Reflector Studs





### Step 7 – Attach Head Assembly to Post

- Unscrew 4 small bolts from head assembly.

 4 Req'd Small Bolts from Head Assembly

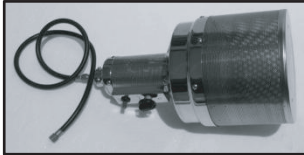

- Load Head Assembly by inserting hose into post.
- Insert Head Assembly into post.
- Control knob should be above decal on post.



- Attach Head Assembly to post, and loosely install four small bolts.



- Tighten bolts securely.

(For models with Entire Reflector, skip to Step 9)

### Step 8 – Install Reflector

## WARNING

Remove protective cover before assemble.

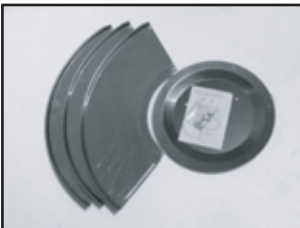

Note: Leave all screws and nuts loose until entire shield is put together to ensure proper alignment. Tighten after sections are aligned.

- Slide two reflector panels together.
- Insert one small screw.



9 Req'd Small Screws

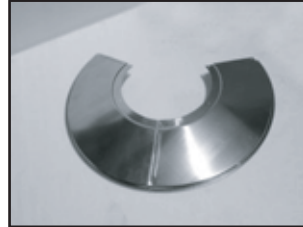

9 Req'd Cap Nuts

- Attach Cap Nut and loosely tighten.

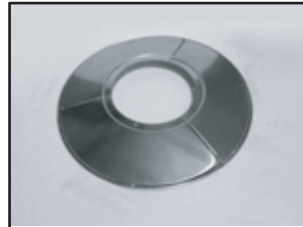
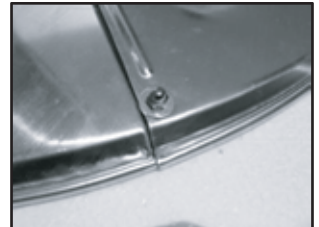

- Place Reflector center plate into middle of reflector panels and follow same procedure above.



- Repeat procedure to complete the assembly of all four sections.

- Fully tighten all of the screws in the rolled edge.

### Step 9 – Attach Reflector Assembly to Studs

- Support Heater.
- Slide 3 Large Flat Washers over threaded end of Studs.



6 Req'd Large Flat Washers



3 Req'd Wing Nuts

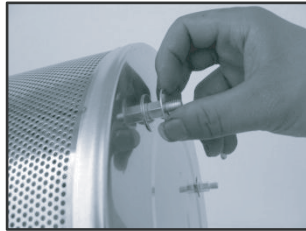
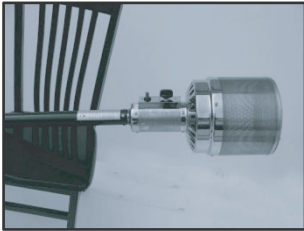

- Position Reflector Assembly on 3 studs.
- Install large flat washers on studs & securely tighten wing nuts but do not over-tighten!

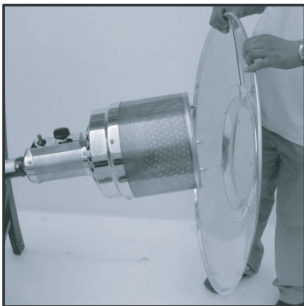

### Step 10 – Connect Hose & Regulator to Cylinder

#### Specifications

- You must provide propane gas and propane cylinder. Use a standard 20 lb. propane cylinder only. (5 gal.)
- Use this heater only with a propane vapor withdrawal supply system. See Chapter 5 of the Standard for Storage and Handling of Liquefied Petroleum Gas, ANSI/NFPA 58. Your local library or fire department should have this book.



Standard 20 lb. tank

- The minimum permissible gas supply pressure of 10 W.C. is required for purpose of input adjustment.
- The minimum hourly of 17000 Btu is required input rating for a heater for automatic operation at ratings less than full input rating.
- The pressure regulator and hose assembly supplied with the appliance must be used.
- The installation must conform with local codes, or in the absence of local codes, with National Fuel Gas Code, ANSI Z223.1.
- A dented, rusted or damaged propane cylinder may be hazardous and should be checked by your cylinder supplier. Never use a propane cylinder with a damaged valve connection.
- The propane cylinder must be constructed and marked in accordance with the specifications for LP gas cylinders of the U.S. Department of Transportation (DOT).
- Never connect an unregulated propane cylinder to the heater.
- Screw regulator onto gas hose. Do not cross-thread.



- Tighten securely with wrenches.
- Attach regulator to cylinder.
- Complete attachment.



- Install cylinder.





## Leak Check

### ! WARNING

- Perform all leak tests outdoors.
- Extinguish all open flames.
- NEVER leak test when smoking.
- Do not use the heater until all connections have been leak tested and do not leak.



Hose / Regulator  
Connection



Regulator / Cylinder  
Connection

- Make 2-3 oz. of leak check solution (one part liquid dishwashing detergent and three parts water).
- Apply several drops of solution where hose attaches to regulator.
- Apply several drops of solution where regulator connects to Cylinder.
- Make sure all Patio Heater & Light valves are OFF.
- Turn Cylinder Valve ON.

#### **If bubbles appear at any connection, there is a leak.**

- Turn Cylinder Valve OFF.
- If leak is at Hose/Regulator connection: tighten connection and perform another leak test.
- If leak is at Regulator/Cylinder Valve connection: disconnect, reconnect, and perform another leak check. If you continue to see bubbles after several attempts, cylinder valve is defective and should be returned to cylinder's place of purchase.

#### **If NO bubbles appear at any connection, the connections are secure.**

- Turn Cylinder Valve OFF.

**NOTE: Whenever gas connections are loosened or removed, you must perform a complete leak test.**

- Complete installation.

## Operation

### ! DANGER

#### • CARBON MONOXIDE HAZARD

- For outdoor use only. Never use inside house, or other unventilated or enclosed areas. This heater consumes air (oxygen). Do not use in unventilated or enclosed areas to avoid endangering your life.

### ! DANGER

#### • EXPLOSION - FIRE HAZARD

- Never store propane near high heat, open flames, pilot lights, direct sunlight, other ignition sources or where temperatures exceed 120 degrees F (49°C).
- Propane vapors are heavier than air and can accumulate in low places. If you smell gas, leave the area immediately.
- Never install or remove propane cylinder while heater is lighted, near flame, pilot lights, other ignition sources or while heater is hot to touch.
- This heater is red hot during use and can ignite flammables too close to the burner. Keep flammables at least 3 feet from sides & 2 feet from top. Keep gasoline and other flammable liquids and vapors well away from heater.
- The propane cylinder must always be stored outdoors in a well ventilated space. Never store propane cylinder in an enclosed area (house, garage, etc.). If heater is to be stored indoors, disconnect the propane cylinder for outdoor storage.

**Caution: Do not attempt to operate until you have read & understand all General Safety Information in this manual and all assembly is complete & leak checks have been performed.**

### **Before Turning Gas Supply ON:**

- Your heater was designed and approved for outdoor use only. Do NOT use it inside a building, garage, or any other enclosed area.
- Make sure surrounding areas are free of combustible materials, gasoline, and other flammable vapors or liquids.
- Ensure that there is no obstruction to air ventilation.
- Be sure all gas connections are tight and there are no leaks.
- Be sure the cylinder cover is clear of debris.
- Be sure any component removed during assembly or servicing is replaced and fastened prior to starting.

### **Before Lighting:**

- Heater should be thoroughly inspected before each use, and by a qualified service person at least annually.
- If relighting a hot heater, always wait at least 5 minutes.
- Inspect the hose assembly for evidence of excessive abrasion, cuts, or wear. Suspected areas should be leak tested. If the hose leaks, it must be replaced prior to operation. Only use the replacement hose assembly specified by manufacturer.

### **Lighting:**

Note: This heater is equipped with a Pilot Light that allows for safer startups and shutdowns. Pilot must be lit before Main Burner can be started.

- 1 Turn Cylinder Valve ON.
- 2 Open Viewing Hole by sliding cover to either side.
- 3 Push Control Knob IN and rotate to Pilot position.

**Note: For initial start or after any cylinder change, hold Control Knob IN for 2 minutes to purge air from gas lines before proceeding.**

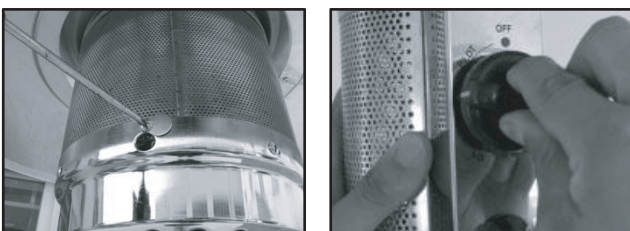

- 4 Push and release the igniter button until pilot flame is visible through Viewing Hole.
- 5 Release Control Knob after 30-60 seconds. Pilot Light will remain lit. If not, return to step 1.
- 6 Turn Control Knob to ON. Main Burner will light immediately. Flame is visible through Viewing Hole. If not, return to step 1.

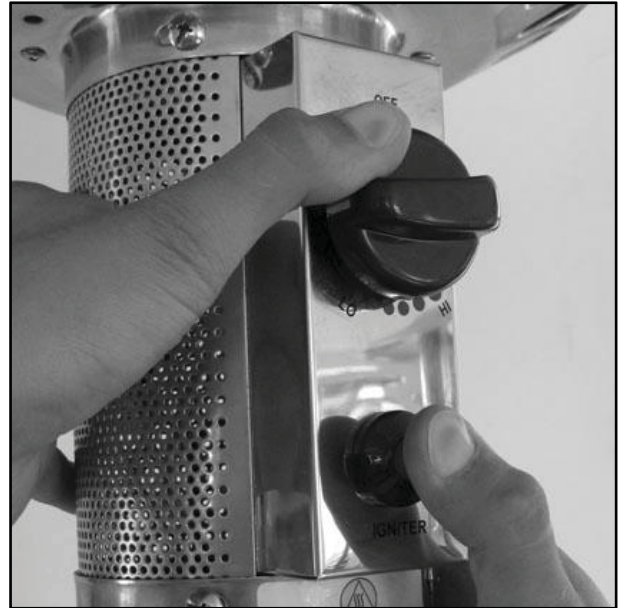

- If for some reason your igniter fails to deliver a spark, your heater can be started by inserting a lit match through the pilot view hole while pushing the control knob in while in the PILOT position.

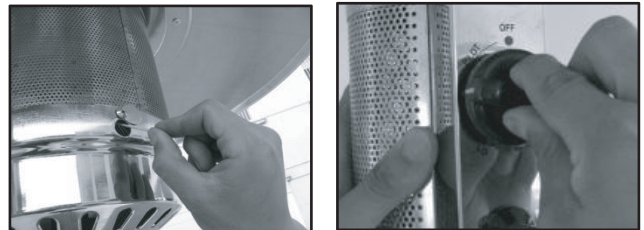

**Note: If pilot fails to remain lit, all valves should be closed and waiting period of at least 5 minutes should pass before attempting to light.**

If you experience any ignition problem please consult "Troubleshooting" on page 11.

Caution: Avoid inhaling fumes emitted from the heater's first use. Smoke and odor from the burning of oils used in manufacturing will appear. Both smoke and odor will dissipate after approximately 30 minutes.

The heater should NOT produce thick black smoke.

Note: The burner may be noisy when initially turned on. To eliminate excessive noise from the burner, turn the Control Knob to the Pilot position. Then, turn the knob to the level of heat desired.

## WARNING

### FOR YOUR SAFETY

Be careful when attempting to manually ignite this heater. Holding in the control knob for more than 10 seconds before igniting the gas will cause a ball of flame upon ignition.

### When heater is ON:

Emitter screen will become bright red due to intense heat. The color is more visible at night.

Burner will display tongues of blue and yellow flame. These flames should not be yellow or produce thick black smoke, indicating an obstruction of airflow through the burners. The flame should be blue with straight yellow tops.

If excessive yellow flame is detected, turn off heater and consult "Troubleshooting" on page 11.

### Re-lighting:

Note: For your safety, Control Knob cannot be turned OFF without first depressing Control Knob in PILOT position and then rotating it to OFF.

- Turn Control Knob to OFF.
- Wait at least 5 minutes, to let gas dissipate, before attempting to relight Pilot.
- Repeat the "Lighting" steps on prior page.

## WARNING

### FOR YOUR SAFETY

Heater will be hot after use. Handle with extreme care.

### Shut Down:

- Turn Control Knob clockwise to Pilot. (Normally, burner will make a slight popping sound when extinguished.) Burner will extinguish but Pilot will remain ON.
- To extinguish Pilot, depress Control Knob and continue to turn it clockwise to OFF.
- Turn Cylinder Valve clockwise to OFF and disconnect Regulator when heater is not in use.

Note: After use, some discoloration of the emitter screen is normal.

## Operation Checklist

For a safe and pleasurable heating experience, perform this check before each use.

### Before Operating:

- I am familiar with entire owner's manual and understand all precautions noted .
- All components are properly assembled, intact and operable.
- No alterations have been made.
- All gas connections are secure and do not leak.
- Wind velocity is below 10 mph.
- Unit will operate at reduced efficiency below 40°F.
- Heater is outdoors (outside any enclosure).
- There is adequate fresh air ventilation.
- Heater is away from gasoline or other flammable liquids or vapors.
- Heater is away from windows, air intake openings, sprinklers and other water sources.
- Heater is at least 24" on top and at least 36" on sides away from combustible materials.
- Heater is on a hard and level surface.
- There are no signs of spider or insect nests.
- All burner passages are clear.
- All air circulation passages are clear.
- Children, pets, clothing, flammable materials and items that can be damaged from radiant heat are away from the heater.
- Children and adults in the area have been alerted to the high temperature hazards: especially burns and clothing fires.
- Children and adults in the area have been warned not to touch heater near engine during operation and until unit has cooled.

### After Operation:

- Gas control is in OFF position.
- Gas Tank valve is OFF.
- Disconnect Gas line.
- Heater is upright in a secure location.

## Troubleshooting

<u>If the problem is:</u>	<u>And this condition exists:</u>	<u>Then do this</u>
<b>Pilot won't light</b>  Note: Heater operates at reduced efficiency below 40°F (5°C)	Cylinder valve is closed	Open valve
	Blockage in orifice or pilot tube	Clean or replace orifice or pilot tube
	Air in gas line	Open gas line and bleed it (pressing control knob in) for not more than 1 - 2 minutes or until you smell gas
	Low gas pressure with cylinder valve fully open	Turn cylinder valve OFF and replace cylinder
	Igniter fails	Use match to light pilot; obtain new igniter and replace
<b>Pilot won't stay lit</b>	Dirt built up around pilot	Clean dirt from around pilot
	Connection between gas valve and pilot assembly is loose	Tighten connection and perform leak check
	Thermocouple is not operating correctly	Replace thermocouple
<b>Burner won't light</b>	Gas pressure is low	Turn cylinder valve OFF and replace cylinder
	Blockage in orifice	Clear blockage
	Control knob is not in ON position	Turn control knob to ON
<b>Burner flame is low</b>	Gas pressure is low	Turn cylinder valve OFF and replace cylinder
	Outdoor temperature is less than 40°F and tank is less than 1/4 full	Use a full cylinder
	Supply hose is bent or kinked	Straighten hose
	Control knob fully ON	Check burner and orifices for blockage
<b>Carbon build-up</b>	Dirt or film on reflector and burner screen	Clean reflector and burner screen
<b>Thick black smoke</b>	Blockage in burner	Remove blockage and clean burner inside and outside

## Maintenance

### WARNING

#### FOR YOUR SAFETY:

- Do NOT touch or move heater for at least 45 minutes after use.
- Reflector is hot to the touch.
- Allow reflector to cool before touching.

To enjoy years of outstanding performance from your heater, make sure you perform the following maintenance activities on a regular basis:

Keep exterior surfaces clean.

- Use warm soapy water for cleaning. Never use flammable or corrosive cleaning agents.
- While cleaning your unit, be sure to keep the area around the burner and pilot assembly dry at all times. Do not submerge the control valve assembly. If the gas control is submerged in water, do NOT use it. It must be replaced.

Air flow must be unobstructed. Keep controls, burner, and circulating air passageways clean. Signs of possible blockage include:

- Gas odor with extreme yellow tipping of flame.
- Heater does NOT reach the desired temperature.
- Heater glow is excessively uneven.
- Heater makes popping noises.



- Spiders and insects can nest in burner or orifices. This dangerous condition can damage heater and render it unsafe for use. Clean burner holes by using a heavy-duty pipe cleaner. Compressed air may help clear away smaller particles.
- Carbon deposits may create a fire hazard. Clean dome and burner screen with warm soapy water if any carbon deposits develop.

Note: In a salt-air environment (such as near an ocean), corrosion occurs more quickly than normal. Frequently check for corroded areas and repair them promptly.

**TIP:**

Use high-quality automobile wax to help maintain the appearance of your heater. Apply to exterior surfaces from the pole down. Do not apply to emitter screen or domes.

**Storage**

**Between uses:**

- Turn Control Knob OFF.
- Disconnect LP source.
- Store heater upright in an area sheltered from direct contact with inclement weather (such as rain, sleet, hail, snow, dust and debris).
- If desired, cover heater to protect exterior surfaces and to help prevent build up in air passages.

Note: Wait until heater is cool before covering.

***During periods of extended inactivity or when transporting:***

- Turn Control Knob OFF.
- Disconnect LP source and move to a secure, well-ventilated location outdoors.

- Store heater upright in an area sheltered from direct contact with inclement weather (such as rain, sleet, hail, snow, dust and debris).
- If desired, cover heater to protect exterior surfaces and to help prevent build up in air passages.
- Never leave LP cylinder exposed to direct sunlight or excessive heat.

Note: Wait until heater is cool before covering.

**Service**

Repair to gas passages and associated components should be done only by a qualified service person.

**Caution: Always allow heater to cool before attempting service.**

**Warranty**

**1 YEAR LIMITED WARRANTY - CUSTOMERS IN CANADA IMPORTANT**

Only return this product to the store if it was purchased within 90 days. If you have problems after 90 days of purchase, please email our customer service department for any questions or concerns: [www.patioheaterpartsonline.com](http://www.patioheaterpartsonline.com) OR PLEASE CALL 888-775-1330 DATED PROOF OF PURCHASE REQUIRED FOR WARRANTY SERVICE.

**WARRANTY**

This product is inspected, tested and carefully packaged to minimize the chance of damage during shipment. If a part (excluding light bulbs and fuses\*) within one year from the date of purchase proves to be defective in material or fabrication under normal use, the part will be repaired or replaced. The Company's obligation under the warranty is to replace or repair defective parts at our discretion. Any expenses or damage resulting from the installation, removal or transportation of the product will be the responsibility of the owner and are not covered by this warranty. The owner assumes all other risks arising out from the use or misuse of the product. The warranty will be void if the product damage or failure is deemed by the Company to be caused by accident, alteration, misuse, abuse, incorrect installation or removal, or connection to an incorrect power source by the owner. The Company neither assumes, nor authorizes any person or entity to assume for it any obligation or liability associated with its products. \* Light bulbs and fuses are not covered under this warranty. If you have any questions regarding the warranty or service, please call our toll free number: 888-775-1330

Distributed by:  
AZ Patio Heaters  
8550 N 91st Ave Ste C-25  
Peoria, AZ 85345

Manufactured by:  
Changzhou Gardensun Furnace Co., Ltd.  
No. 1, Boyi Town, Changzhou City,  
Jiangsu Province P.R. China