



BEVERAGE-AIR

3779 Champion Blvd., Winston-Salem, NC 27105
1-888-845-9800 Fax# 1-336-245-6453
<http://www.Beverage-Air.com>

Commercial Refrigeration Equipment General Specification

3 Year Parts/Labor Warranty Additional 2 Year Compressor Warranty

GF SERIES—GLASS FROSTERS

The most complete line of glass frosters available with the right size to fit your application (24", 34" and 48" sizes available). Shallow well design is "user-friendly" with access to the interior base within easy reach. Flexibility in design provides for plate storage and chilling by removing adjustable shelving.

CABINET CONSTRUCTION

Standard, cabinet exterior construction includes attractive, wear resistant vinyl on steel in black finish. Equipped with stainless steel top, easy glide lids and counter top with edge. Stainless exterior options available.

Standard interior construction utilizes galvanized steel with sliding stainless steel lids which are easily removable for cleaning.

Foamed-in-place CFC and HCFC-free polyurethane insulation enhances the structural strength of the cabinet and helps increase energy efficiency.

REFRIGERATION

Refrigeration system uses R404A refrigerant, which is CFC and HCFC-free for compliance with environmental safety concerns. System includes automatic defrost of coils as standard, with a built in condensate evaporator system, which eliminates the need for floor drains or additional plumbing.

Condensate elimination is automatic and non-electric.

ELECTRICAL

Units wired at factory and ready for connection to a 115/60/1 phase, 15 amp dedicated outlet. 6' long cord and plug set included.



115/60/1
NEMA-5-15P

ELECTRICAL CONNECTION

Units pre-wired at factory and include 6' long cord and plug set.

Item No. _____
Quantity _____

GLASS FROSTERS GF SERIES

MODELS:
GF24
GF34
GF48



GF24L



GF34L (shown in stainless exterior finish)



GF48L



*Note: Not all markings may apply to all model variations.

Available From:

Model Specified _____	Store# _____
Location _____	Quantity _____



ELECTRICAL CONNECTION

Units pre-wired at factory and include 8' long cord and plug set.



Glass Frosters

Models: GF24L, GF34L, GF48L

MODEL	GF24L	GF34L	GF48L
EXTERNAL DIMENSIONAL DATA			
Length Overall (inches)	24"	34"	48"
Length Overall (mm)	610	864	1219
Depth Overall (inches)	26"	26"	26"
Depth Overall (mm)	660	660	660
Height Overall— (inches)	33 5/8"	33 5/8"	33 5/8"
Height Overall—(mm)	854	854	854
Number of lids	1	1	2
INTERNAL DIMENSIONAL DATA			
NET Capacity (cubic ft.)	4.4	6.6	9.6
NET Capacity (Liters)	125	187	272
Internal Length Overall (inches)	19 3/4"	29 3/4"	44"
Internal Length Overall (mm)	502	756	1118
Internal Depth Overall (inches)	17 1/2"	17 1/2"	17 1/2"
Internal Depth Overall (mm)	445	445	445
Internal Height Overall (inches)	18 1/4"	18 1/4"	18 1/4"
Internal Height Overall (mm)	464	464	464
Number of dividers	2	2	4
Number of 12 oz. mugs	76	94	164
Number of 8" plates	100	150	250
ELECTRICAL DATA			
Full Load Amperes 115/60/1	7	6.5	7.5
ENERGY CONSUMPTION (KWH)			
	6.54	5	6.83
REFRIGERATION DATA			
Horsepower	1/3	1/3	1/3
WEIGHT DATA			
Gross Weight (Crated lbs)	183	227	276
Gross Weight (Crated kg)	83	103	125

PLAN VIEWS

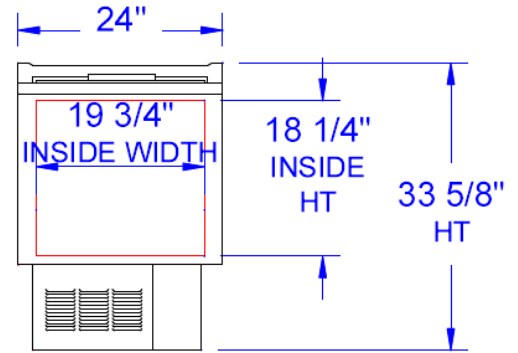

**FRONT
GF24L**

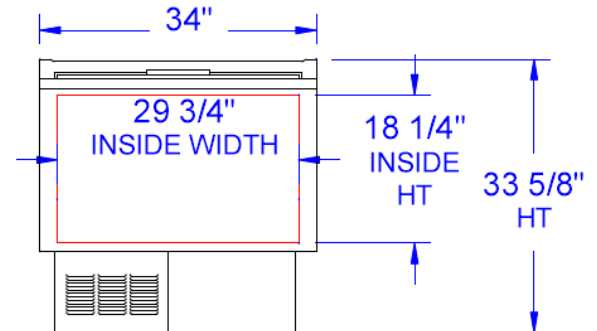

**FRONT
GF34L**

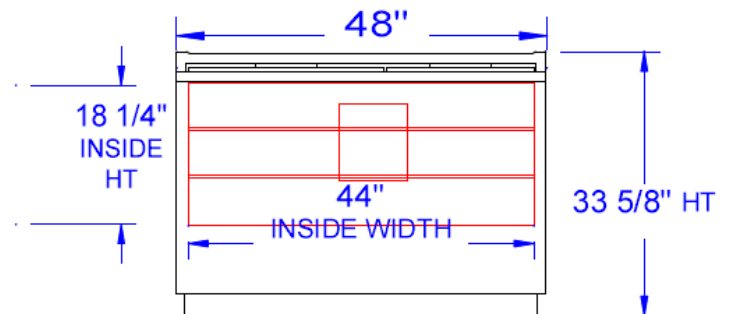

**FRONT
GF48L**

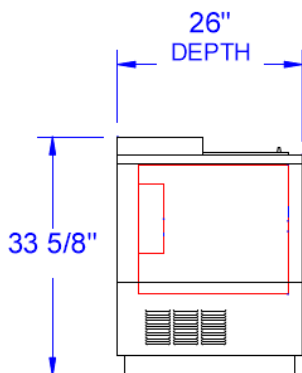

**COMMON END
END**



*Note: Not all markings may apply to all model variations.

BEVERAGE-AIR® CORPORATION

3779 Champion Blvd. • Winston-Salem, NC 27105 USA • (336) 245-6400 • Fax (336) 245-6453 • (888) 845-9800 • www.beverage-air.com

Specifications are subject to change without prior notice. 06/13