



BEVERAGE-AIR

3779 Champion Blvd., Winston-Salem, NC 27105
1-888-845-9800 Fax# 1-336-245-6453
<http://www.Beverage-Air.com>

Commercial Refrigeration Equipment General Specification

3 Year Parts/Labor Warranty Additional 2 Year Compressor Warranty

UCRD SERIES—29" DEPTH

Versatile, compact (29" depth) models for under the counter refrigerated storage of food products. Working height is 34 1/2".

CABINET CONSTRUCTION

Heavy duty construction includes exterior stainless steel on front, sides, door(s) and grille. Cabinet back and bottom are galvanized steel. Interior liner is made of corrosion resistant aluminum. Interior thermometer is standard.

In cabinets with doors and drawers, doors are mounted to face of cabinet on cartridge-style hinges permitting them to self close under their own weight. Hinges also allow doors to stay open 120° and permit easy door removal for service and cleaning if required. A plug-in type vinyl magnetic gasket is attached to each door for positive seal.

Cabinet insulation is CFC and HCFC-free foamed-in-place polyurethane of two-inch minimum thickness. 6" high casters are standard, 2 include brakes.

DRAWER CONSTRUCTION

Drawer frames are constructed of heavy-duty stainless steel and are supported on heavy-duty telescoping drawer slides for maximum support of stored food products. Slides have locking mechanism to prevent from drawers being pulled off of cabinets. Upper pull-out drawers accommodate 6" deep pans. Lower pull-out drawers accommodate two 4" deep pans. Heavy-duty pan divider supports are supplied. Foodservice pans for drawers are not included. Snap-type vinyl magnetic gasket is attached to each drawer for positive seal. Drawers extend 23" (when opened).

REFRIGERATION

Refrigeration system utilizes R134a refrigerant governed by a capillary tube system. Automatic (non-electric) condensate evaporator is provided. Interior forced-air system with high humidity evaporator coils, provides the ideal environment for food preservation.

ELECTRICAL

Units wired at factory and ready for connection to a 115/60/1 phase, 15 amp dedicated outlet. 8' long cord and plug set included.

ELECTRICAL CONNECTION

Units pre-wired at factory and include 8' long cord and plug



Item No. _____
Quantity _____

UNDERCOUNTER REFRIGERATORS WITH DRAWERS UCRD 29" DEPTH SERIES

MODELS:
UCRD27A
UCRD48A
UCRD60A
UCRD72A



UCRD27A-2



UCRD48A-2

Available From:



*Note: Not all markings may apply to all model variations.

Model Specified _____

Store# _____

Location _____

Quantity _____



BEVERAGE-AIR

Undercounter Refrigerator With Drawers
Models: UCRD27A, UCRD48A, UCRD60A, UCRD72A

MODEL	UCRD27A-2	UCRD48A-2	UCRD48A-4	UCRD60A-2	UCRD60A-4	UCRD72A-2	UCRD72A-4	UCRD72A-6
EXTERNAL DIMENSIONAL DATA								
Length Overall (inches)	27"	48"	48"	60"	60"	72"	72"	72"
Length Overall (mm)	686	1219	1219	1524	1524	1829	1829	1829
Depth Overall (inches)	29 1/4"	29 1/4"	29 1/4"	29 1/4"	29 1/4"	29 1/4"	29 1/4"	29 1/4"
Depth Overall (mm)	743	743	743	743	743	743	743	743
Height Overall—(inches)	34 1/2"	34 1/2"	34 1/2"	34 1/2"	34 1/2"	34 1/2"	34 1/2"	34 1/2"
Height Overall—(mm)	876	876	876	876	876	876	876	876
Number of doors	-	1	-	1	-	2	1	-
Number of drawers	2	2	4	2	4	2	4	6
Drawer Extension (when opened)	23"	23"	23"	23"	23"	23"	23"	23"
INTERNAL DIMENSIONAL DATA								
NET Capacity (cubic ft.)	7.3	13.9	13.9	17.1	17.1	21.5	21.5	21.5
NET Capacity (Liters)	207	394	394	484	484	609	609	609
Internal Length Overall (inches)	23"	44"	44"	55 7/8"	55 7/8"	68"	68"	68"
Internal Length Overall (mm)	584	1118	1118	1419	1419	1727	1727	1727
Internal Depth Overall (inches)	19"	19"	19"	19"	19"	19"	19"	19"
Internal Depth Overall (mm)	483	483	483	483	483	483	483	483
Internal Height Overall—(inches)	23"	23"	23"	23"	23"	23"	23"	23"
Internal Height Overall—(mm)	584	584	584	584	584	584	584	584
Number of shelves	-	2	-	2	-	4	2	-
ELECTRICAL DATA								
Full Load Amperes 115/60/1	4	3.3	3.3	8.2	8.2	8.2	8.2	8.2
REFRIGERATION DATA								
Horsepower	1/6	1/5	1/5	1/4	1/4	1/4	1/4	1/4
WEIGHT DATA								
Gross Weight (Crated lbs)	157	180	180	235	235	372	372	372
Gross Weight (Crated kg)	71	82	82	107	107	169	169	169

PLAN VIEWS

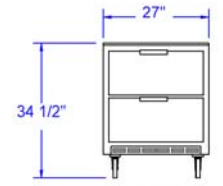

FRONT VIEW
UCRD27A-2

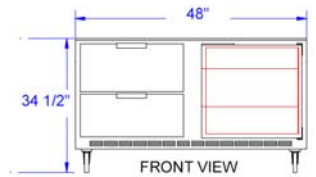

FRONT VIEW
UCRD48A-2

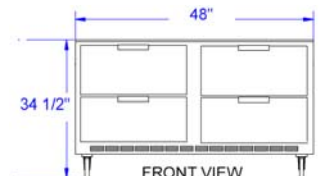

FRONT VIEW
UCRD48A-4

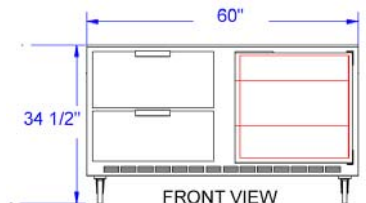

FRONT VIEW
UCRD60A-2

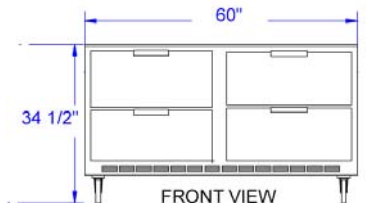

FRONT VIEW
UCRD60A-4



Note: Not all markings may apply to all model variations.
 *N/A: Not available at time of printing.

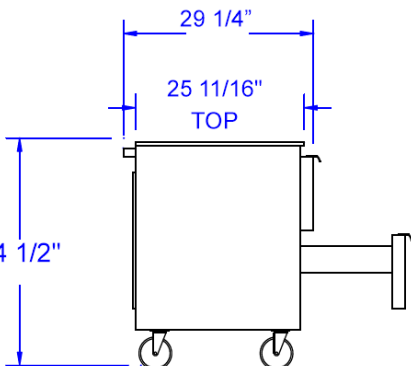

END VIEW

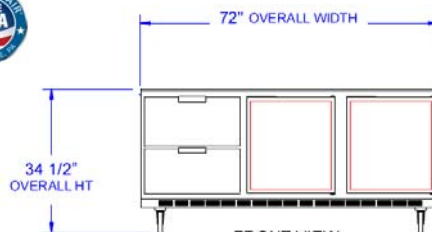

FRONT VIEW
UCRD72A-2

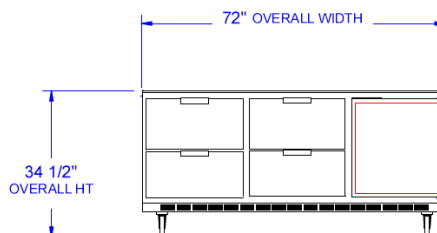

FRONT VIEW
UCRD72A-4

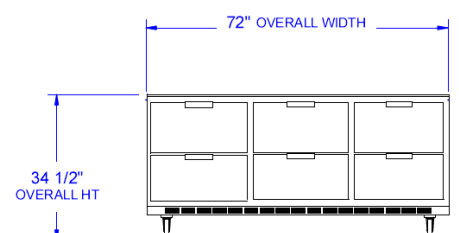

FRONT VIEW
UCRD72A-6

BEVERAGE-AIR® CORPORATION

3779 Champion Blvd. • Winston-Salem, NC 27105 USA • (336) 245-6400 • Fax (336) 245-6453 • (888) 845-9800 • www.beverage-air.com

Specifications are subject to change without prior notice. 06/13