



## Manual for MC61/MFC6000

### SETUP INSTRUCTIONS

Evaporative cooling works on the principle of heat absorption by moisture evaporation. Simply put, heat is removed from the air as water evaporates. You feel this principle in action when you step out of a swimming pool or shower and feel cool as water evaporates from the surface of your skin. Your evaporative cooler works on the same principle. The fan pulls hot outside air through the wet cooling pads, where the air is cooled by evaporation and then discharged from the cooler



**STOP!!!**  
**READ THIS FIRST**



**Do not return this item to the place of purchase unless instructed to do so by Hessaire customer support**

If you should find any missing parts, any loose, or dislodged items or have any questions please call us first. We have parts and expert support that can help you. We value your business and are here to help. We can ship any replacement or warranty parts to you quickly so your Hessaire mobile cooler can keep you cool.



### **Hessaire Customer Service Centers**

**Hessaire Products, Inc.**

11550 U.S. Highway 278 E.

Holly Pond, AL 35083

United States

Phone: (256) 734-3003

Fax: (256) 734-3201

Website: [www.hessaire.com](http://www.hessaire.com)

Email: [evap@hessaire.com](mailto:evap@hessaire.com)

**Phoenix, AZ Location Contact:**

Phone: (602) 251-2003

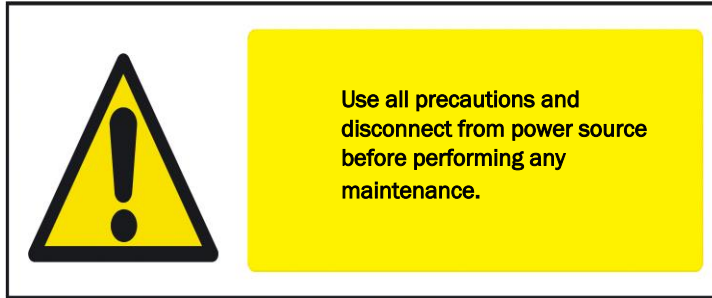

## Getting started

### Contents:

Evaporative Cooler  
(1)  
Hardware Bag (1)  
Casters (4)



### Tools / Materials Needed:

Drill with #2  
Phillip's bit  
Or Phillip's head  
screwdriver

## Operating Instructions

Evaporative cooling works on the principle of heat absorption by moisture evaporation. Simply put, heat is removed from the air as water evaporates. You feel this principle in action when you step out of a swimming pool or shower and feel cool as water evaporates from the surface of your skin.

Your evaporative cooler works on the same principle. The fan pulls hot outside air through the wet cooling pads, where the air is cooled by evaporation and then discharged from the cooler.

### Inspection:

After unpacking your evaporative cooler, carefully inspect for any damage that may have occurred during transit. Inspect for loose, missing or damaged.

## **Hessaire Products Inc. Manufacturing Warranty**

### **EVAPORATIVE COOLER**

Each new cooler is warranted to be free from defects in material or workmanship for one full year from the date of original purchase. If a component is found to be defective in this one year period, it will be repaired or replaced with a new or refurbished product at the option of the factory.

Should a warranty issue arise, please contact the dealer from whom the fan was purchased. A Return Material Authorization (RMA) number is required for all returns.

#### **What is not covered by the warranty:**

1. Malfunctions resulting from misuse, negligence, alteration or lack of necessary maintenance.
2. Loss of time, inconvenience, use of product or other consequential damages due to defects.
3. Return transportation costs. All return transportation costs are the responsibility of the purchaser.

#### **Damaged Shipments:**

Hessaire is not responsible for damaged shipments or shortages resulting from carrier mishandling. Notify your carrier's office immediately to file a claim. Keep damaged goods and containers for inspection until advised by the carrier as to disposal.

#### **Returns:**

All items must be returned with all original parts and packaging. Additional charges may apply for any missing or damaged parts.

The customer must re-package and ship their item(s) back to the manufacturer at their own expense.

No freight cost/shipping cost will be re-funded to the customer.

The customer needs to provide us with the tracking number of the shipment.

Upon receipt of the product, including original parts and packaging, we may issue a full refund for the product or may repair or replace the item with a new or refurbished product.

If our returns department finds that the item is not defective, you may be responsible for additional shipping costs as well as a 10-30% re-stocking fee.

## Section 3 Getting started

### Key Operational Points:

1. Your cooler must be positioned in front of an open window or door if it is to operate effectively.
2. Always ensure that there is another open window or door through which the air can exhaust from the room.
3. Ensure the filter is kept clean throughout the summer season.
4. At the end of each day run your cooler on FAN ONLY for 30 minutes to dry out the filter.
5. Prior to putting your cooler away for winter, always:
  - a. Drain the tank and wipe out clean.
  - b. Clean the filter
  - c. Reassemble and run on FAN ONLY for 30 minutes to dry out the filter.

### Location! Location! Location!

Having completed assembly of your cooler, position the unit with its back to an open window or door. This will allow fresh air to be drawn through the cooler and exhausted from the room. Constant air change is essential and part of the fresh air benefit from evaporative air cooling.

Remember your cooler has been designed to operate even if it runs out of water. No damage will be caused to the pump if cooler runs out of water.

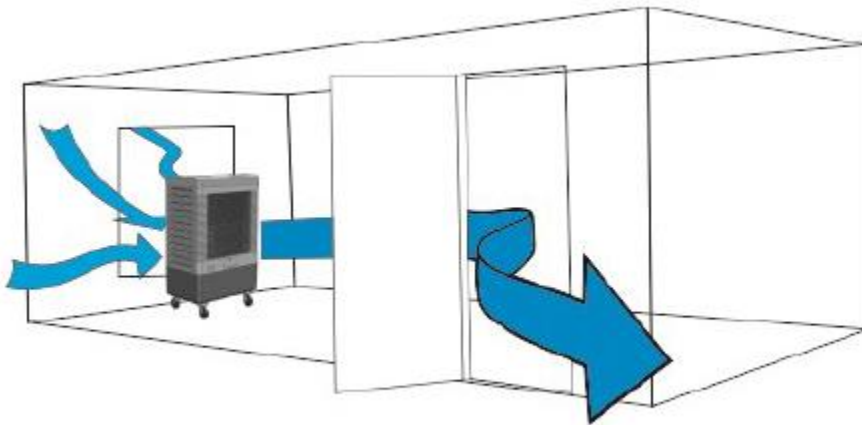



### Safety Rules

1. Read and follow all instructions, cautions, and warnings. Failure to do so could result in personal injury, death or property damage.
2. Unit must be in the **OFF** position and **UNPLUGGED** from power receptacle before performing any maintenance.
3. Make sure the electrical power source conforms to the requirement of the evaporative cooler(s) as well as local codes.
4. To reduce the risk of fire or electrical shock, do not expose electrical connections to water.
5. Do not touch electrically live components.
6. Adequate ventilation is required.
7. Assure that all power cords do not come in contact with any sharp edges, hot surfaces or chemicals. Immediately replace any damaged parts.
8. This appliance is not intended for use by persons (including children) with reduced physical, sensory or mental capabilities, or lack of experience and knowledge, unless they have been given supervision or instruction concerning use of the appliance by a person responsible for their safety. Children should be supervised to ensure that they do not play with the appliance.

## Section 4A

### Cooler Set Up and Operation

Hessaire Coolers are pre-assembled and ready to operate. Simply remove the packaging and then carefully remove the unit from the box. Install Casters. Lock the 2 locking wheels before filling and turning on fan to keep the cooler from moving from the air velocity.

**NOTICE:** the Xel50 Media pad will have a slight odor when it is new. This is normal. It will dissipate after a period of time depending on the use time. Draining the tank often during the break-in period will help speed this up. (See draining tank in section 5)

### Filling Cooler or Connecting to Water Supply

Move the cooler to an area where it can be filled

#### Manual fill method

The cooler can be filled via the front fill door by hose or bucket. Using the water fill indicator to monitor water level, simply depress the fill door and the spring lock will release and open it. To close, simply push it closed and locked.

#### Auto fill connections

Connect to a water supply using a garden hose or coil hose (supplied by customer), or a direct water line. (Parts for direct connection can be obtained at any hardware store.) Simply attach hose adaptor (supplied with cooler) to the float valve nipple protruding from cooler. Verify water tight connections by visually examining the hose connection

#### CAUTION:

Water inlet pressure should be limited to a maximum 50 PSI. If valve is overcome, install a pressure reducer (25 PSI) on nipple first. (It can be obtained at hardware stores in irrigation section.) Hose bib needs only be opened slightly to supply water to float valve and the cooler only needs to be about half filled when in auto fill configuration. The float is already set to that level.



## Section 4B

### Connecting to a power supply.

Plug the Hessaire cooler into any 115 volt power supply. It is permissible to use extension cords when needed. It is not recommended to use a GFCI circuit usually found in garage or patio areas. These outlets/circuits are sensitive and may trip inadvertently to the cooler in normal operation. Should that be the only power supply please be aware of this and if the GFCI trips simply reset it.



## Section 4C

### Using the Control Switches Mechanical Version

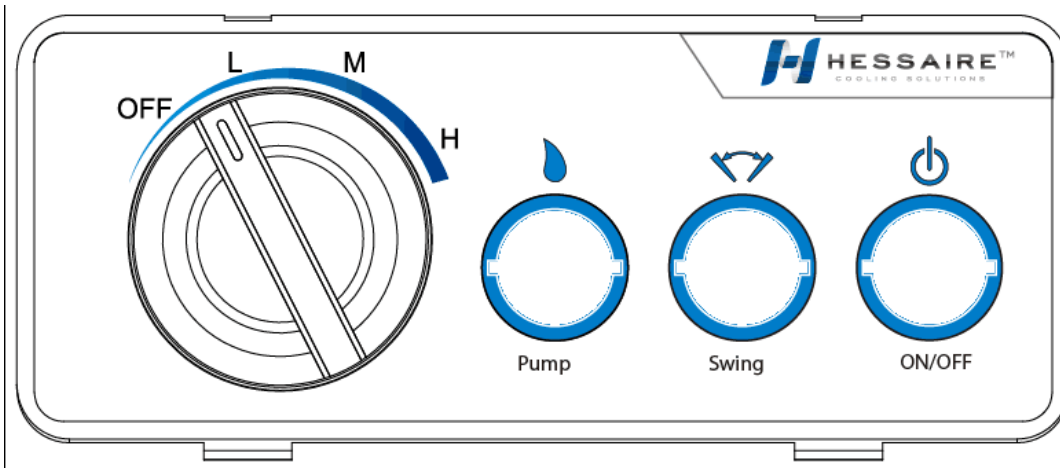

**Rotary Switch/Motor Speed** Has 4 positions. (Clockwise from OFF)

OFF, LOW Fan Only, MED Fan Only, HI Fan Only.

### **Pump Switch**

Controls the pump



## Middle Rocker Switch

Controls the fan Oscillation

## Power Switch

Controls power to the main controls, it will be lit when it is in the ON position, dark when OFF. When it is OFF the other switches will not function.

## Using the Control Switches Electronic Version

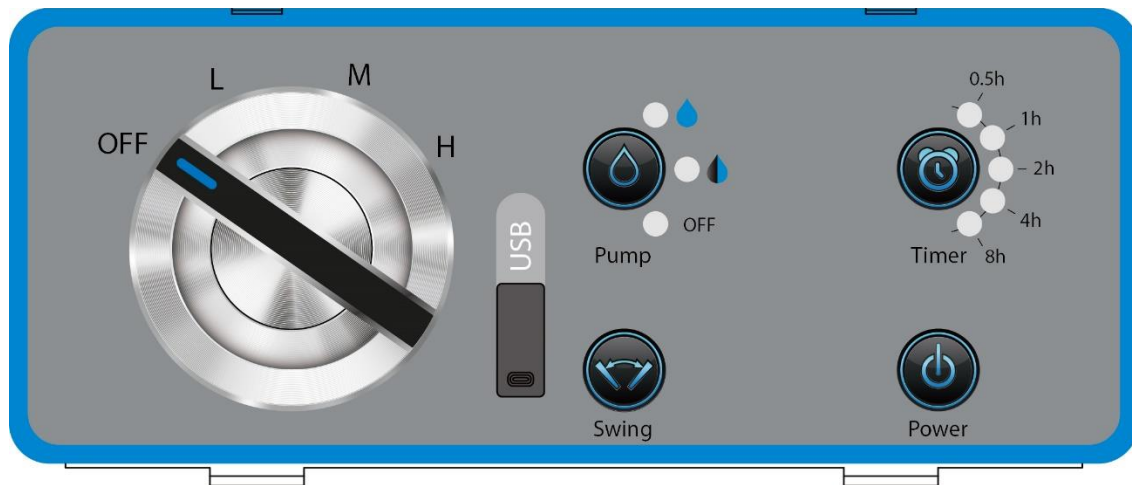

## Rotary Switch/ Motor Speed has 4 Positions (clockwise from OFF)

Fan OFF, LOW Fan, MED Fan, HIGH Fan.

## Pump Variable Control Button/ Low Water Indicator

This button will **blink red** if low water level is detected and pump operation will be interrupted. It will continue to blink until proper water level is achieved.

**Press for Pump OFF light-** Pump will be off

**Press for Pump Variable light.** (Middle light)

The pump will cycle on and off allowing the pad to become wet and then start to become dry. This will control the humidity level in the cooled space if indoors as well as extend the time before refill is needed if using manual fill mode.

**Press for PUMP ON light** - Pump will function continually when this light is lit.

**Swing Button** - Press to operate oscillation motor to swing the air left to right.

**Timer Button Lit when engaged** - Press to select the desired timer selection, cooler will stop running all features when selected time expires.

**Power Button** – If Green light, all functions will be able to operate. Red light, all control functions will be off.

## Section 5

**Cooler Maintenance** **WARNING: (DO NOT remove back panel with cooler running)**

For best operation and long useful life the following maintenance and cleaning procedures should be followed.

### Cleaning Cooler and Pads

At regular intervals your Hessaire Mobile cooler should be **shut down** and **disconnected** from power supply. The water tank should be drained of dirty water and sprayed out with fresh water and refilled. The more you do this the better it will work and less calcium will develop on pads or other surfaces. You may spray through the cooling pads to wash them out and allow water to deposit in the tank to be drained away. The removable panel and media pad can be sprayed out on the ground to clean pad. Use light pressure when spraying pads. **NEVER spray pads with water while cooler is operating and fan is running. This can cause damage to motor and will void the warranty.**

**Removal of the Back Panel, same for the side panel (Disconnect power supply before this procedure.)**

Unscrew the screws at top of back panel (3). Lift panel up and pull out at the bottom. Then slide panel out of the cabinet. You will now have access to the pump, float valve and water distributor spreaders.

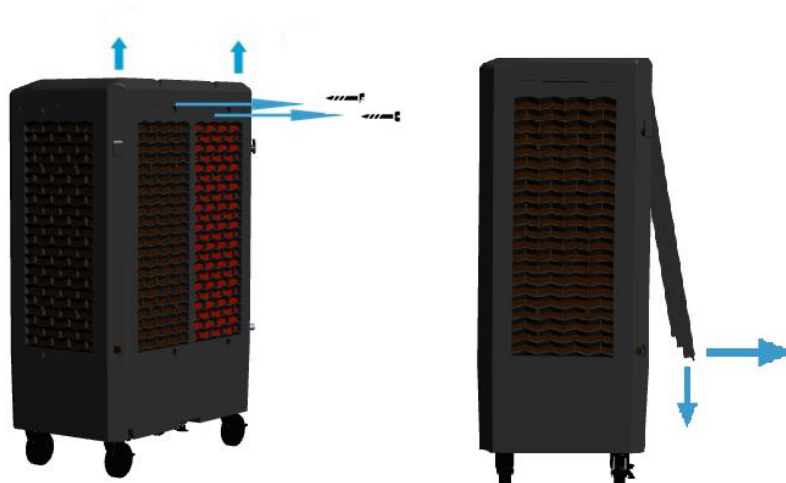

Unscrew the screws in the back panel first, then pull the back panel up.

Pull out the bottom of the back panel then take it down.

## Draining the Cooler Tank

Unscrew drain cap from drain assemble and drain away water. You may tip the unit carefully to the drain side to help drain all the water out.

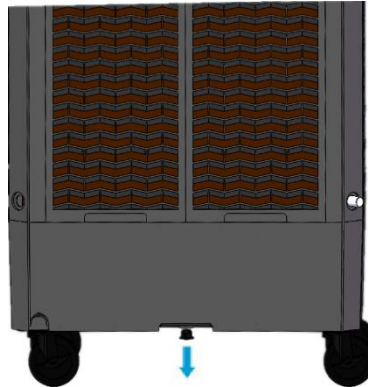

## Removal and Replacement of Xel50 Cooling Media.

The cooling pads are made from a special resin impregnated craft paper specially designed for evaporative cooling. They will last many years if maintained properly and water quality is maintained. It is not necessary to remove the pads to clean them.

Inspect the pads for deposits of calcium on the air entering side. If the flute cells are clogged or the pad is very heavy it may be time to change the media. New OEM Xel50 media can be purchased where you bought the cooler. Follow these steps for replacing the pads.

1. With access panel removed, simply pull off the pad retainer disc from the pad pin. Older models may have a pushed on pin that will need to be pulled away using pliers to grasp disc and pull away. Be careful not to break the pin although the new pads will come with new pins and disc. The newer models will have a threaded disc that will unscrew from the pin
2. With disc removed, remove the pins from the pads and carefully remove pads from the fixed side mounting frame. Then do the same for the back panel or panels.
3. Xel50 pads are made with a 45/45 flute and can be installed either side to the frame. Just make sure the distribution pad that is fixed to the top of the new media pad is at the top. This allows water get onto the top of the pad evenly. The installation of the pads is opposite of the removal, install the pad, insert pins and install the retaining disc. YOU'RE DONE... It's that easy.
4. Reinstall the back panel and you are ready to use the cooler again.

## Pump Maintenance and Replacement. (Disconnect power supply before this procedure.)

The submersible pump is mounted inside the tank to the bottom with a retention bracket. While you are cleaning the cooler the pump may be removed and the strainer cap on the bottom of pump can be cleaned of debris. If pump has failed and needs replacing follow these steps:

1. Remove retention bracket.

2. Remove the switch control panel from the top of cooler, by inserting a small screwdriver into the tap slots and pop loose.
3. The pump is connected to the control via the white plastic clip. Disconnect the pump clip and feed the plastic clip through the control box into the cooler.
4. The pump cable is connected to the cooler by twist clips that are mounted in the side of the corner between the left pad and the front of cooler. You may have to remove that pad to get to the clips. Also there may be cable ties holding cable to the motor mounting bracket. Remove the pump from cooler when cable is free.
5. Reinstall the new pump in reverse. Being sure to reconnect the cable in the twist ties and secure the cable in a manner of which it stays clear of fan blade when cooler is running. Reattach the pump clip in the control box and reinstall the control panel in its place. Be sure not to pull any other wires loose from control switches when you have panel loose.
6. Reinstall the control panel into the cabinet making sure it is seated. And YOU'RE DONE!

**Float Valve Replacement or Adjustment: (Disconnect power supply before this procedure.)**

The float valve is mounted to the left side of cooler if you are facing the front grill. It is held in place by the retaining nut that is visible from the outside. The rubber washer is between the nut and cabinet. The rear panel will have to be removed to adjust the float (if the water level is too high or too low) or remove and replace a float that has failed to shut off water supply. **Note: Be sure that the PSI of the supply water is within the 50 PSI spec. before determining the float has failed.**

1. The float valve can be purchased where you purchased your cooler.
2. Remove any hose adapters attached to the float valve nipple.
3. Remove the rear panel assembly as instructed in Section 5.
4. Remove the float valve retaining nut and rubber washer. Remove float valve from cabinet.
5. Reinstall the float valve in reverse. Set the valve adjustment to around 60 degrees for best results.

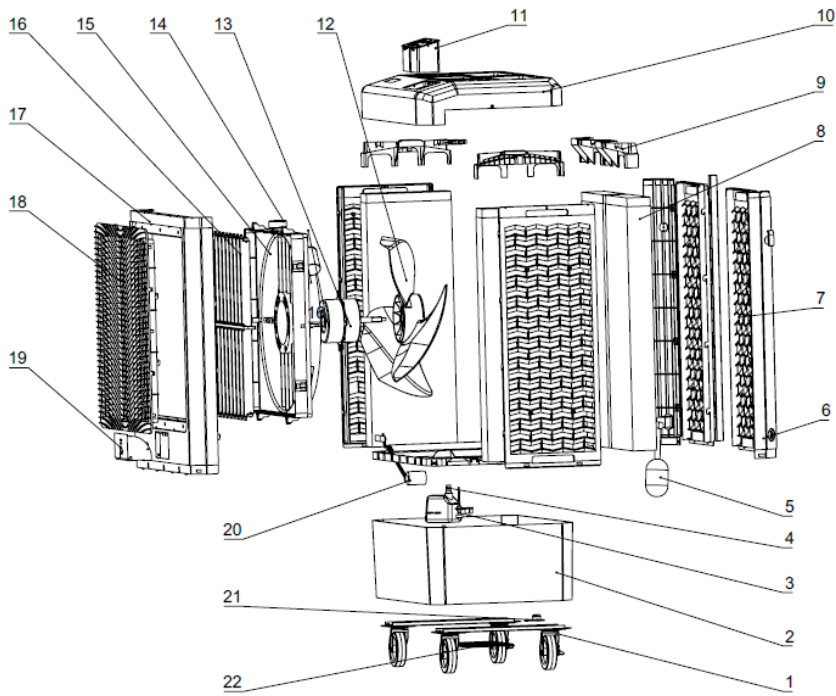

No.	Parts name	Parts number
1	Caster	6061061
	Caster with Lock	6061062
2	Water Tank	6061064
3	Water Level Sensor	6061065
4	Pump	6061050
5	Float Valve	6061058
6	Right pillar	6061079
7	Rear Panel	6061004
8	Media	6061053
9	Water Distributor	6061070
10	Top Cover	6061068
11	Control Panel	6061069
12	Fan Blade	6061052
13	Motor	6061051
14	Oscillating Motor	6061057
15	Motor Bracket	6061072
16	Oscillator Rib	6061074
17	Front Frame	6061073
18	Grill	6061075
19	Water Filling Door	6061076
	Water Level Display	6061077
21	Drain Plug	6061063
22	Bottom Cover	6061078

## QUICK TROUBLESHOOTING TABLE

Problem	Cause/Remedy
1. Cooler fails to work at all	1.1 Check that the unit is plugged properly.
	1.2 Check the POWER switch, push it to "ON".
	1.3 The TIMER switch is "OFF", turn it to "ON".
	1.4 Make sure cooler is not plugged into a tripped GFIC outlet. If so, reset GFIC or move to non GFIC outlet.
2. Cooler does not pump	2.1 Pump is not activated. Push the PUMP switch to "ON".
	2.2 Water level is low. Fill with water and make sure pump is activated.
	2.3 Be sure the pump and pump hose is clear of debris.
	2.4 Pump may be defective. Replace pump.
3a. Fan does not operate	3.1 Check that unit is plugged properly.
	3.2 Check the POWER switch, push it to "ON".
	3.3 If connected to a GFCI outlet, check if it is tripped.
	3.4 Troubleshoot rotary switch.
3b. Fan runs slow at start up	3b.1 Replace motor capacitor.
4. Louver does not operate	4.1 Louver does not move. Louver switch. Position to "ON".
	4.2 Check Oscillator motor for proper placement and operation.
5. Water leakage	5.1 Check the cap of the drain assembly, make sure it tightened.
	5.2 Inspect tank for cracks or breakage.
	5.3 Make sure cooler is level.
	5.4 Check media pads for buildup allowing water out on outside of pad frame -- change media if needed.
	5.5 If water is coming out fan, check for leaks in water distribution hoses and/or leaks at hose connections to spreaders,
	5.6 Be sure there is at least 4 inches of space for rear panel free from wall or other obstruction. This could make the side panels release water to airstream due to increased air velocity through the sides.
	5.7 Spreaders may have scale buildup allowing water to pool and spill over into airstream---Clean spreaders.
6a. Oscillation does not work 6b. Power does not start 6c. Slow in the power	6a.1 The oscillation does not work with USB plugged in.
	6b.1 Check if USB plugged in, It must be unplugged for USB to start.
	6c.1 There is a slow in the power when first plug into USB



11550 US Hwy 278 E  
Holly Pond, AL, 35083  
Phone: (256)734-3003  
Fax: (256)734-3201  
[www.Hessaire.com](http://www.Hessaire.com)