

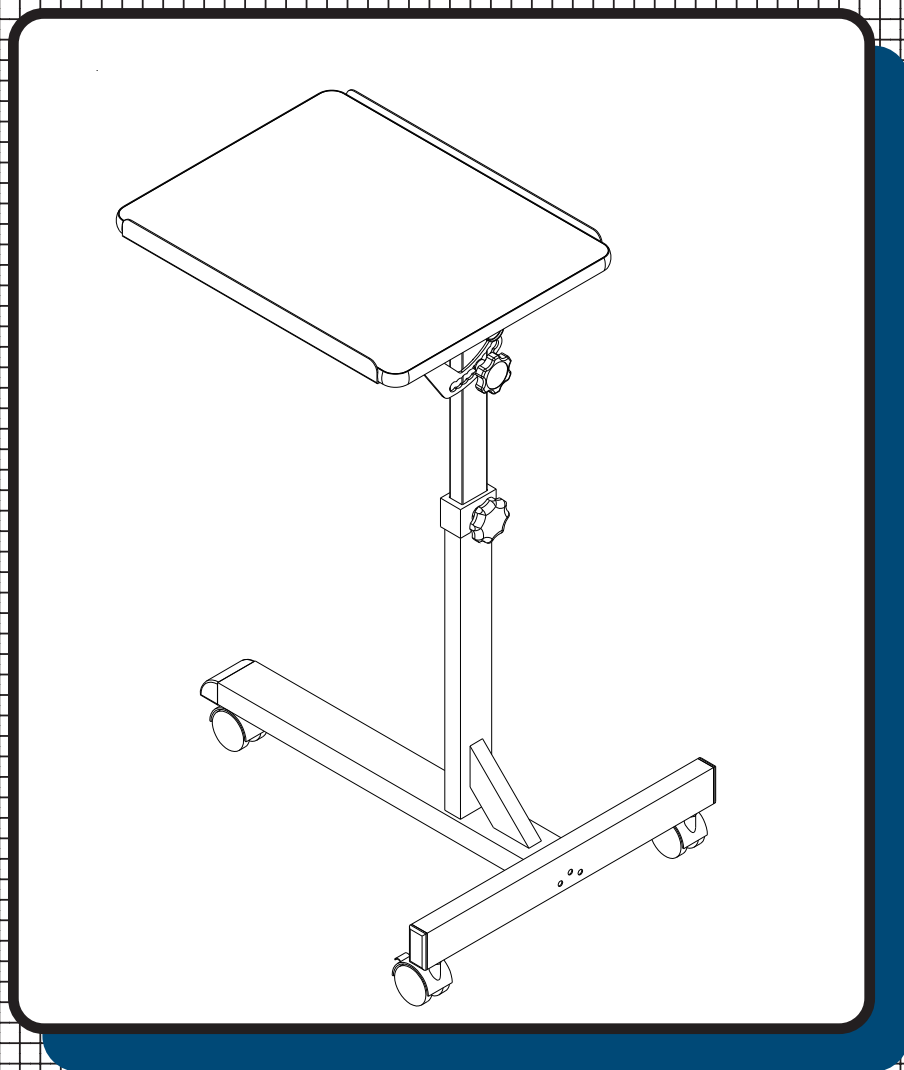









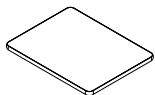

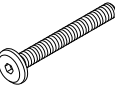

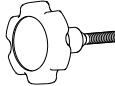







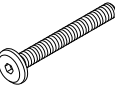

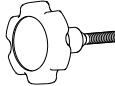





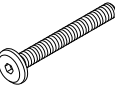

# #89819 Lap-JR

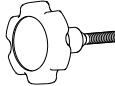
## Laptop/Reading Desk

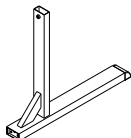
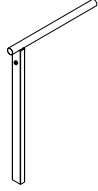
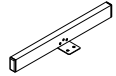

# Assembly Instructions

# #89819 LAP-JR

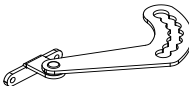
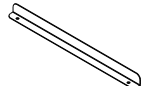
Part	Drawing	Description	Qty	Part	Drawing	Description	Qty																																								
P-1		Top Platform	1 EA	<h3>Hardware List</h3> <table border="0"> <tr> <td>A</td> <td></td> <td>Socket Screw M6X15mm</td> <td>9 EA</td> </tr> <tr> <td>A1</td> <td></td> <td>Socket Screw M6X45mm</td> <td>3 EA</td> </tr> <tr> <td>B</td> <td></td> <td>Wood Screw 1/2"</td> <td>4 EA</td> </tr> <tr> <td>C</td> <td></td> <td>Large Knob</td> <td>1 EA</td> </tr> <tr> <td>D</td> <td></td> <td>Small Knob</td> <td>1 EA</td> </tr> <tr> <td>E</td> <td></td> <td>2" Locking Caster</td> <td>3 EA</td> </tr> <tr> <td>F</td> <td></td> <td>Allen Wrench</td> <td>1 EA</td> </tr> <tr> <td>G</td> <td></td> <td>Caster Wrench</td> <td>1 EA</td> </tr> <tr> <td>M</td> <td></td> <td>Plastic Cap</td> <td>1 EA</td> </tr> <tr> <td>N</td> <td></td> <td>Plastic Sleeve</td> <td>1 EA</td> </tr> </table>				A		Socket Screw M6X15mm	9 EA	A1		Socket Screw M6X45mm	3 EA	B		Wood Screw 1/2"	4 EA	C		Large Knob	1 EA	D		Small Knob	1 EA	E		2" Locking Caster	3 EA	F		Allen Wrench	1 EA	G		Caster Wrench	1 EA	M		Plastic Cap	1 EA	N		Plastic Sleeve	1 EA
A		Socket Screw M6X15mm	9 EA																																												
A1		Socket Screw M6X45mm	3 EA																																												
B		Wood Screw 1/2"	4 EA																																												
C		Large Knob	1 EA																																												
D		Small Knob	1 EA																																												
E		2" Locking Caster	3 EA																																												
F		Allen Wrench	1 EA																																												
G		Caster Wrench	1 EA																																												
M		Plastic Cap	1 EA																																												
N		Plastic Sleeve	1 EA																																												
P-2		Lower Receiver	1 EA																																												
P-3		Upper Insert	1 EA																																												
P-4		Foot	1 EA																																												
P-5		C-Clamp	2 EA																																												
P-6		Tilting Bracket	1 EA																																												
P-7		Security Stop	2 EA																																												

# Assembly Diagram

**READ THROUGH INSTRUCTIONS FROM BEGINNING TO END BEFORE STARTING TO ASSEMBLE UNIT.**

- 1.) Identify and Separate all the Parts and Hardware.
- 2.) Attach Foot (P-4) on the end of Lower Receiver (P-2) using 3 Flat Head screws (A1).  
(Do not tighten screws all the way.)
- 3.) Secure Foot (P-4) on the end of Lower Receiver (P-2) using 2 Flat Head screws (A).
- 4.) Insert 3 Locking Casters (E) into Lower Receiver (P-1) and Foot (P-4) as shown in illustration # 1. Tighten all Casters using Caster Wrench (G).

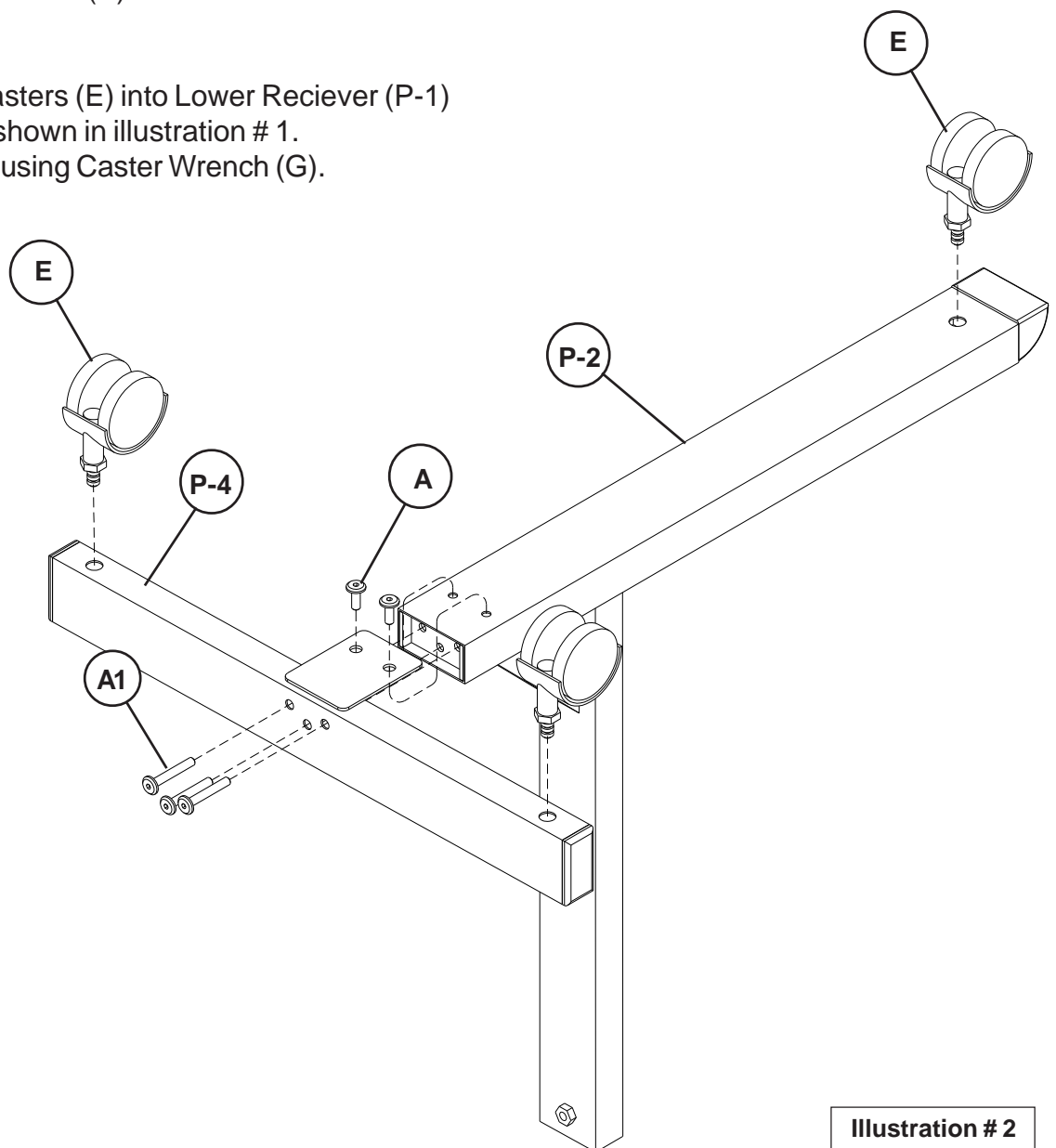

Illustration # 2

5.) Attach Top Platform (P-1) to Upper Insert (P-3) using 2 C-Clamps (P-5) and 4 Flat Head screws (A) as shown in illustration # 2.

6.) Attach 2 Security Stops (P-7) using 4 Wood screws (B) and philips head screwdriver.

7.) Attach Tilting Bracket (P-6) to the Top Platform (P-1) using 2 Flat Head screws (A). Secure Tilting Bracket to Upper Insert (P-3) using the Large Knob (C).

8.) Tighten all the screws at this time using Allen Wrench (F).

Illustration # 2

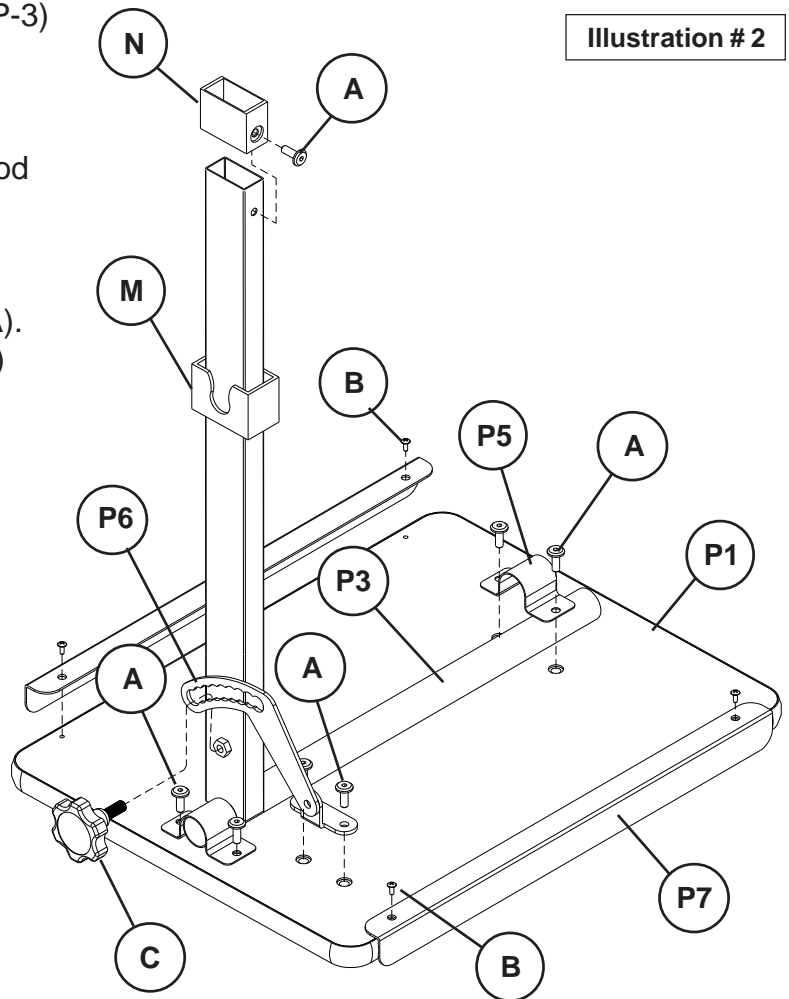
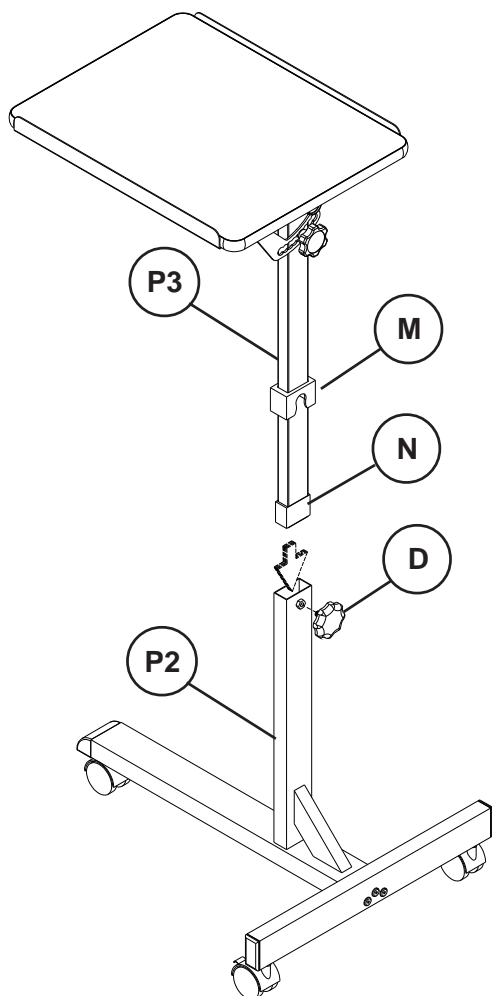

Illustration # 3



9.) Slide Plastic Cap (M) on the Upper insert (P-3) with Cutout on the same side as the tilting bracket as shown in illustration # 2. Attach the Plastic sleeve (N) over the end of insert. Make sure that the hole on the Part N and the hole on the Upper insert (P-3) line up, then secure it with a Flat Head screw (A).

10.) Insert Upper insert (P-3) into the Lower Receiver (P-2) as shown in illustration # 3. Slide Part M down, so that it is resting on top of the Lower Receiver Tube (P-2). Adjust to the desired height and secure with the Small Knob (D) as shown in Illustration #3.