

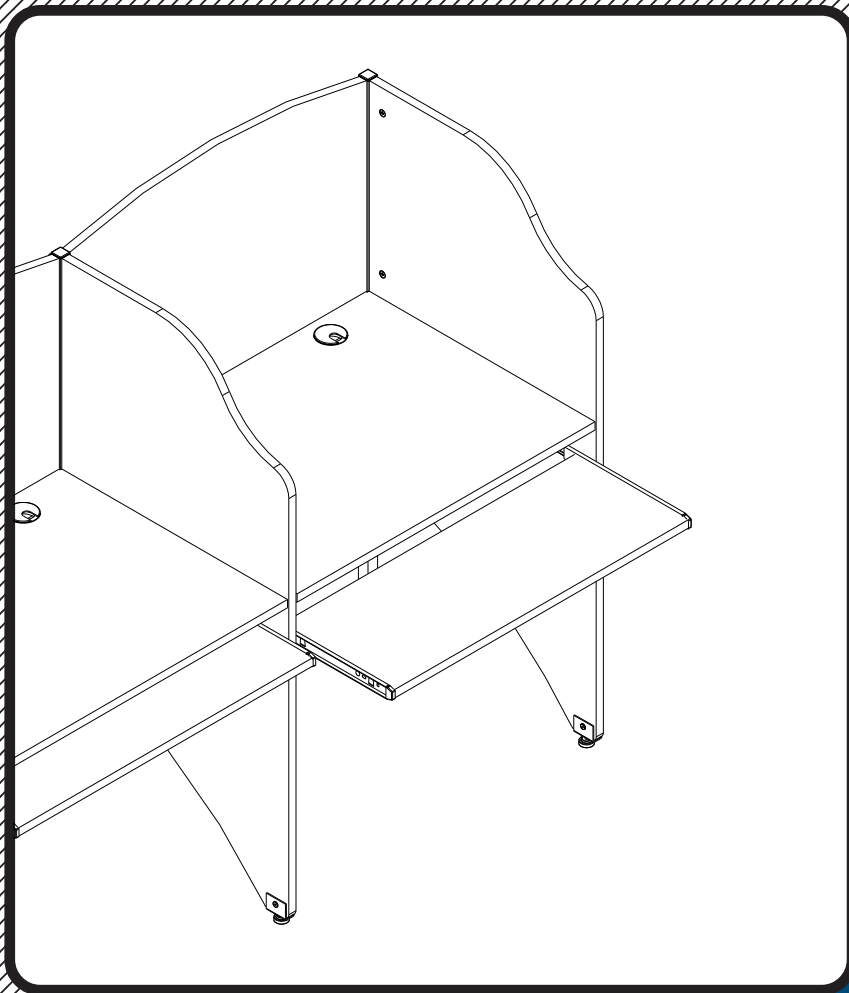













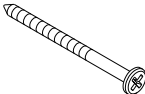



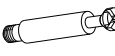





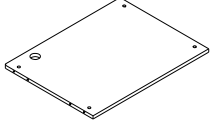
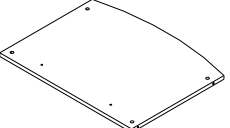
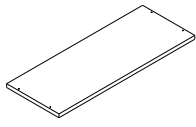
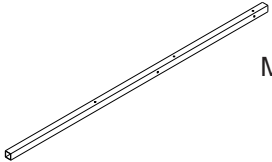
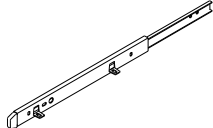
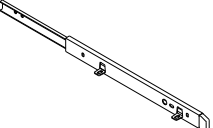
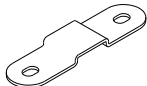
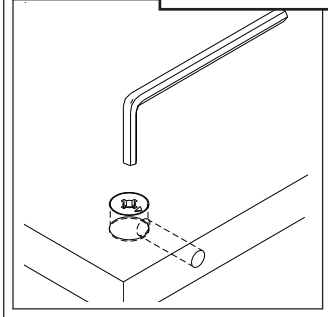
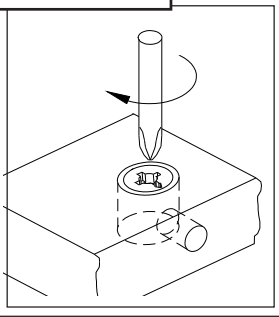

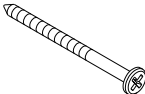



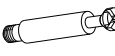





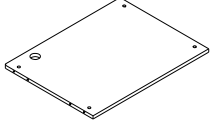
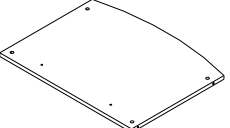
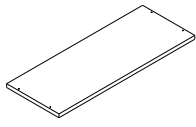
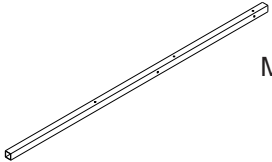
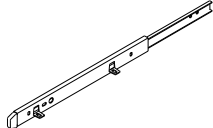
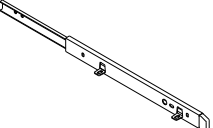
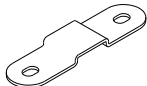
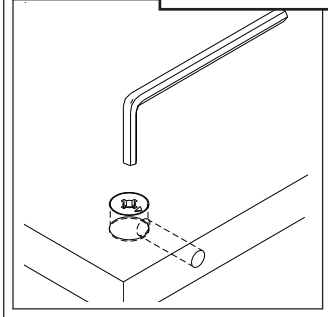
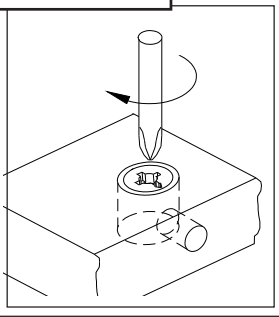

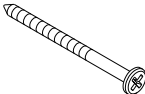
89869

# Add-On Floor Carrel

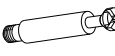

## Assembly Instructions

# 89869 Add-On Floor Carrel

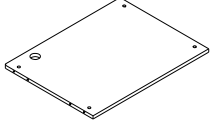
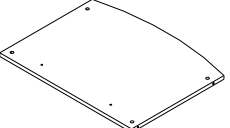
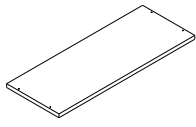
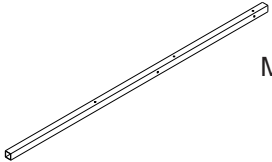
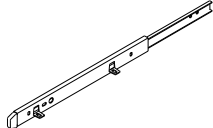
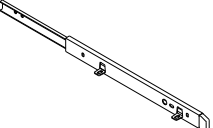
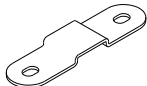
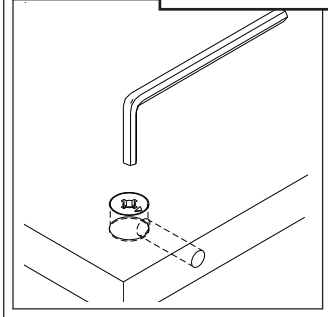
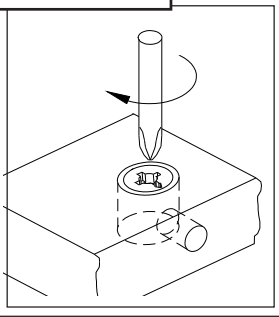
Part	Drawing	Description	Qty	Part	Drawing	Description	Qty																																																																																																
P-1		Middle Side Panel	1 EA	<div style="border: 1px solid black; border-radius: 15px; padding: 10px;"> <h3 style="text-align: center;">Hardware List</h3> <table border="0"> <tr> <td>A</td> <td></td> <td>Socket Screw M5X15 mm</td> <td>1 EA</td> </tr> <tr> <td>A1</td> <td></td> <td>Wood Screw #6X1/2</td> <td>12 EA</td> </tr> <tr> <td>A2</td> <td></td> <td>Wood Screw #8X2 1/4</td> <td>2 EA</td> </tr> <tr> <td>B</td> <td></td> <td>Interior Threaded Post</td> <td>1 EA</td> </tr> <tr> <td>B1</td> <td></td> <td>Washer</td> <td>4 EA</td> </tr> <tr> <td>C</td> <td></td> <td>Cam Lock</td> <td>11 EA</td> </tr> <tr> <td>D</td> <td></td> <td>Cam Post</td> <td>11 EA</td> </tr> <tr> <td>E</td> <td></td> <td>Wood Dowel</td> <td>4 EA</td> </tr> <tr> <td>F</td> <td></td> <td>Glide Bracket</td> <td>1 EA</td> </tr> <tr> <td>G</td> <td></td> <td>Glide</td> <td>2 EA</td> </tr> <tr> <td>H</td> <td></td> <td>Grommet Sleeve</td> <td>1 EA</td> </tr> <tr> <td>J</td> <td></td> <td>Grommet Cap</td> <td>1 EA</td> </tr> <tr> <td>K</td> <td></td> <td>Allen Wrench</td> <td>1 EA</td> </tr> </table> </div> <tr> <td>P-2</td> <td></td> <td>Top Panel</td> <td>1 EA</td> </tr> <tr> <td>P-3</td> <td></td> <td>Back Panel</td> <td>1 EA</td> </tr> <tr> <td>P-4</td> <td></td> <td>Keyboard Panel</td> <td>1 EA</td> </tr> <tr> <td>P-5</td> <td></td> <td>Middle Leg</td> <td>1 EA</td> </tr> <tr> <td>P-6</td> <td></td> <td>Left Keyboard Slide</td> <td>1 EA</td> </tr> <tr> <td>P-7</td> <td></td> <td>Right Keyboard Slide</td> <td>1 EA</td> </tr> <tr> <td>P-8</td> <td></td> <td>Ganging Bracket</td> <td>2 EA</td> </tr> <tr> <td colspan="4"> <div style="border: 1px solid black; padding: 5px; width: fit-content; margin: 10px auto;"> <p><b>Note:</b> Camlocks can be turned with Allen Wrench, or Large Phillips Screwdriver</p> </div> </td> </tr> <tr> <td colspan="4"> <div style="display: flex; justify-content: space-around;">   </div> </td> </tr> <tr> <td colspan="8" style="text-align: right;"> <p><b>Tools required:</b> Phillips Head Screwdriver</p> </td> </tr>				A		Socket Screw M5X15 mm	1 EA	A1		Wood Screw #6X1/2	12 EA	A2		Wood Screw #8X2 1/4	2 EA	B		Interior Threaded Post	1 EA	B1		Washer	4 EA	C		Cam Lock	11 EA	D		Cam Post	11 EA	E		Wood Dowel	4 EA	F		Glide Bracket	1 EA	G		Glide	2 EA	H		Grommet Sleeve	1 EA	J		Grommet Cap	1 EA	K		Allen Wrench	1 EA	P-2		Top Panel	1 EA	P-3		Back Panel	1 EA	P-4		Keyboard Panel	1 EA	P-5		Middle Leg	1 EA	P-6		Left Keyboard Slide	1 EA	P-7		Right Keyboard Slide	1 EA	P-8		Ganging Bracket	2 EA	<div style="border: 1px solid black; padding: 5px; width: fit-content; margin: 10px auto;"> <p><b>Note:</b> Camlocks can be turned with Allen Wrench, or Large Phillips Screwdriver</p> </div>				<div style="display: flex; justify-content: space-around;">   </div>				<p><b>Tools required:</b> Phillips Head Screwdriver</p>							
A		Socket Screw M5X15 mm	1 EA																																																																																																				
A1		Wood Screw #6X1/2	12 EA																																																																																																				
A2		Wood Screw #8X2 1/4	2 EA																																																																																																				
B		Interior Threaded Post	1 EA																																																																																																				
B1		Washer	4 EA																																																																																																				
C		Cam Lock	11 EA																																																																																																				
D		Cam Post	11 EA																																																																																																				
E		Wood Dowel	4 EA																																																																																																				
F		Glide Bracket	1 EA																																																																																																				
G		Glide	2 EA																																																																																																				
H		Grommet Sleeve	1 EA																																																																																																				
J		Grommet Cap	1 EA																																																																																																				
K		Allen Wrench	1 EA																																																																																																				
P-2		Top Panel	1 EA																																																																																																				
P-3		Back Panel	1 EA																																																																																																				
P-4		Keyboard Panel	1 EA																																																																																																				
P-5		Middle Leg	1 EA																																																																																																				
P-6		Left Keyboard Slide	1 EA																																																																																																				
P-7		Right Keyboard Slide	1 EA																																																																																																				
P-8		Ganging Bracket	2 EA																																																																																																				
<div style="border: 1px solid black; padding: 5px; width: fit-content; margin: 10px auto;"> <p><b>Note:</b> Camlocks can be turned with Allen Wrench, or Large Phillips Screwdriver</p> </div>																																																																																																							
<div style="display: flex; justify-content: space-around;">   </div>																																																																																																							
<p><b>Tools required:</b> Phillips Head Screwdriver</p>																																																																																																							

# Assembly Diagram

## To Assemble:

Identify and Separate all the Parts and Hardware.

1. Remove Keyboard from #89830 Carrel as shown in illustration # 1a. Remove left leg Assembly from #89830 Carrel as shown in illustration # 1b.

Illustration # 1a

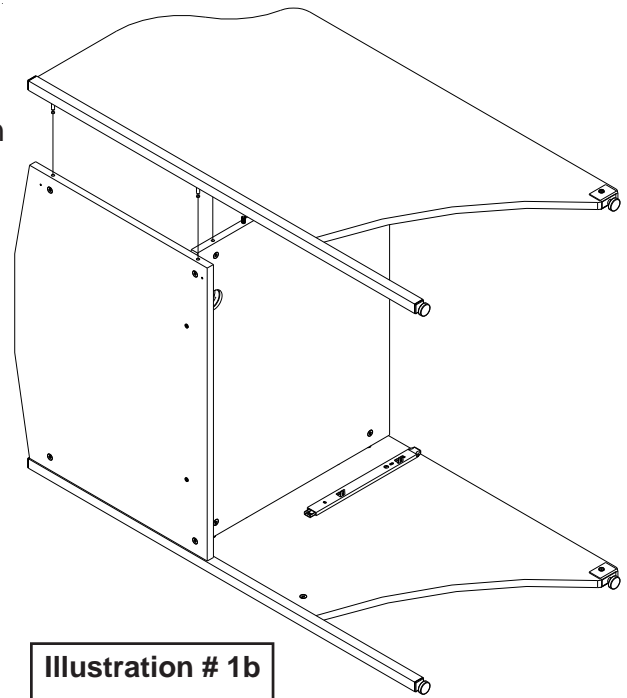
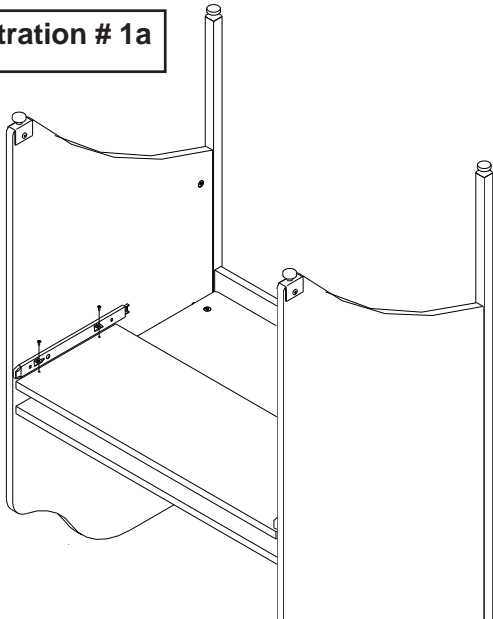

Illustration # 1b

2. Place the Middle Leg (P-5) with the three threaded holes facing up. Install 7 Cam Posts (D) in Leg as shown in illustration # 2.
3. Install 1 Leveling Glide (G) in the bottom of leg as shown in illustration # 2.
4. Tighten Cam Posts (D) using Phillips Screwdriver.

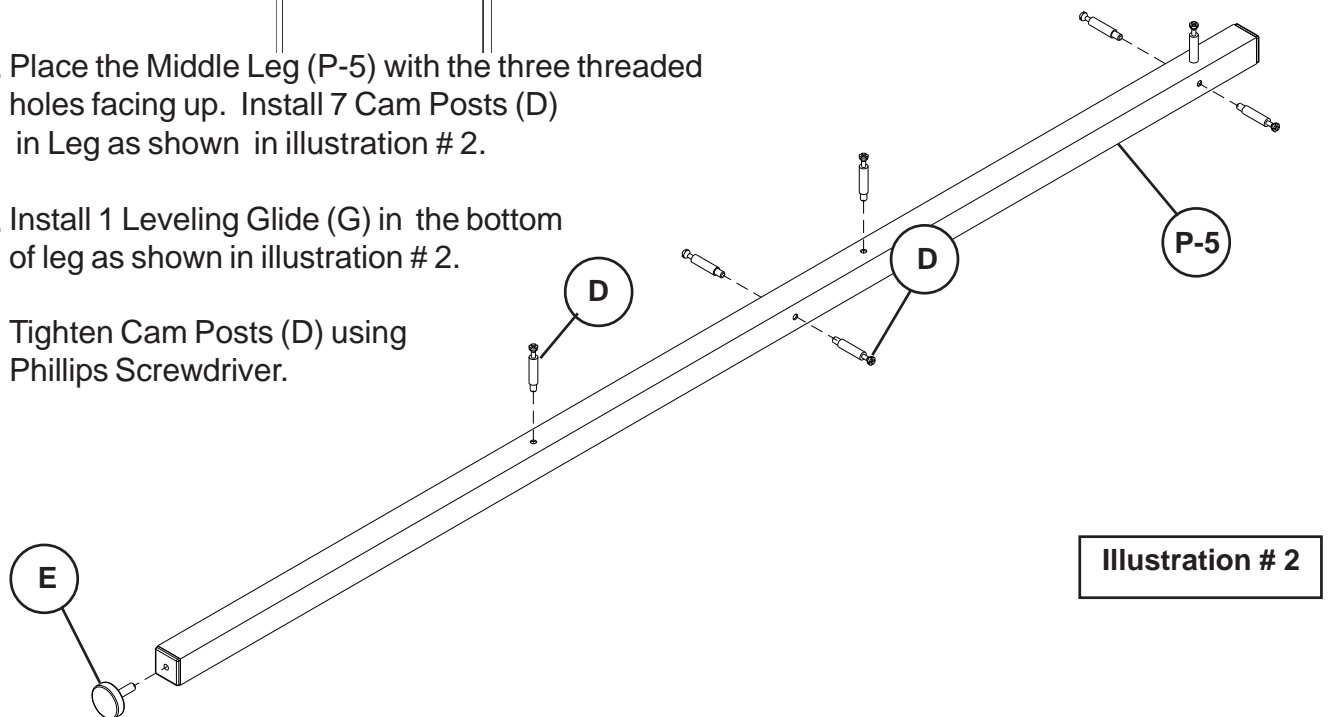

Illustration # 2

5. Place the Middle Side Panel (P-1) with the Camlocks(C) facing up and install 2 each Cam Posts (D) in the 2 threaded insert nuts (Pre-installed) as shown in illustration # 3.

6. Install 2 each Dowels (E) into the holes as shown in illustration # 3.

7. Attach Middle Side Panel (P-1) to Middle Leg (P-5) as shown in illustration # 3. Secure by turning the Cam Locks (C) 1/4 turn until they lock.

8. Attach Left Keyboard Slide (P-6) to the Middle Side Panel (P-1) using 2 each Screws (A1) as shown in illustration #3.

9. Attach 1 Glide Bracket (F) using 1 Socket Screws (A) and 1 Interior Threaded Posts (B) as shown in illustration #3. Tighten Screws using Phillips Screwdriver.

10. Insert 1 Glide (G) into the Glide Bracket (F) as shown in illustration #3.

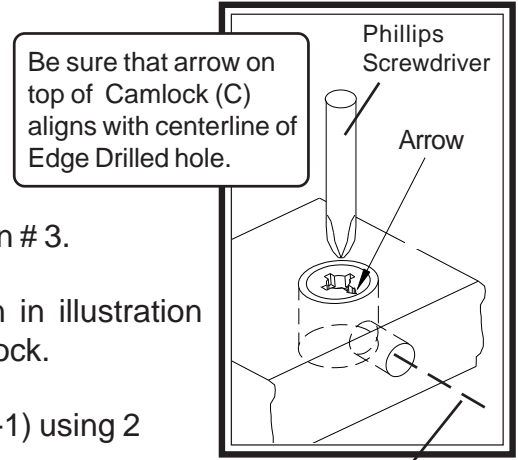

Centerline of Edge Drilled hole.

**Note:** (B) screw is in 1st HOLE

To Secure Cam Locks, Insert Large Phillips Head Screwdriver and turn Cam Lock 1/4 turn (90 degrees) clockwise.

**Illustration # 3**

11. Install 2 each Dowels (E) into the holes as shown in illustration # 3.
12. Turn the Middle Side Panel (P-1) over and install 2 each Cam Posts (D) in the 2 threaded insert nuts (Pre-installed) as shown in illustration # 4.
13. Attach Right Keyboard Slide (P-7) to the Middle Side Panel (P-1) using 2 each Screws (A1) as shown in illustration #4.

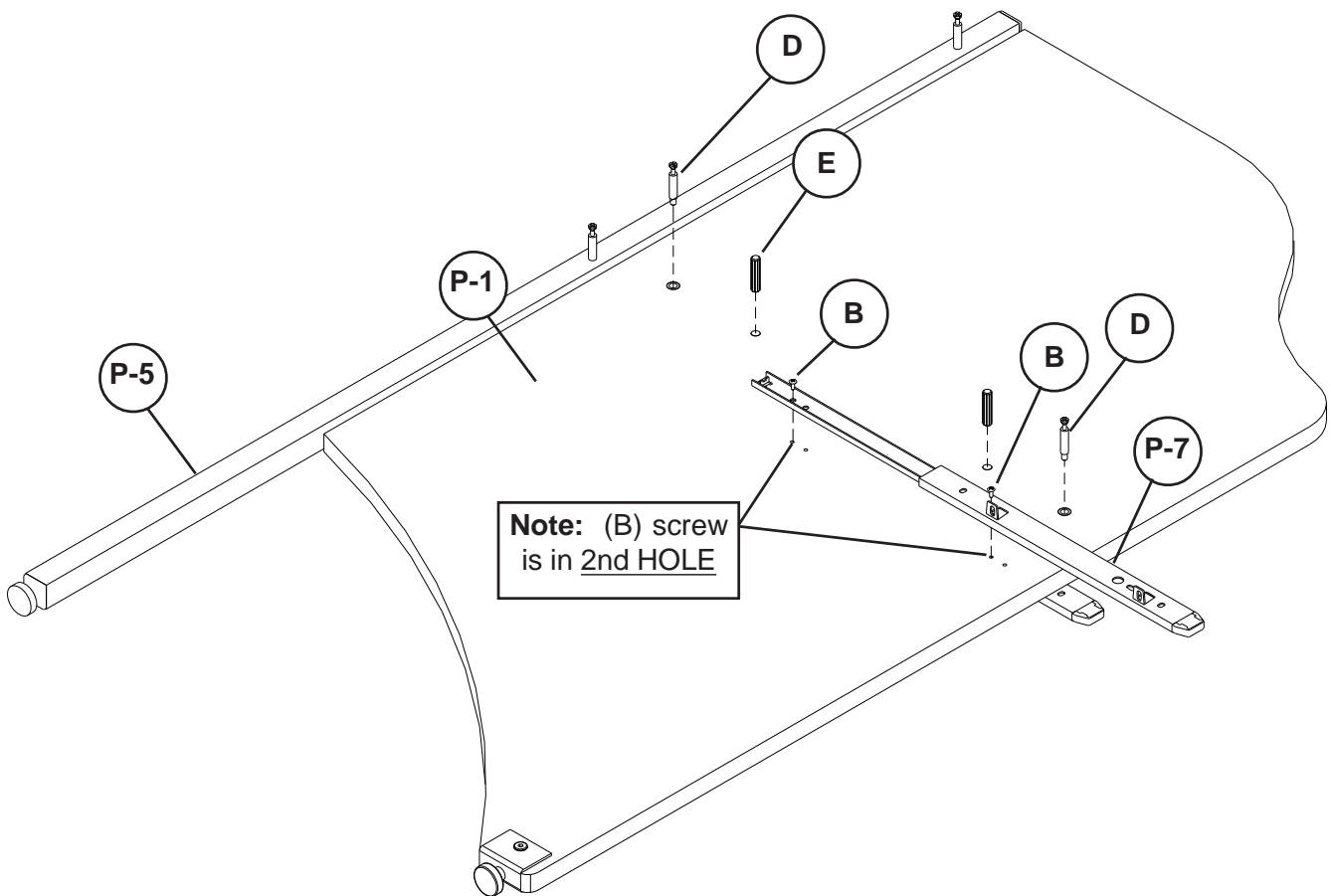

**Illustration # 4**

14. Attach Middle Side Panel (P-1) to Top Panel and the Middle Leg (P-5) to the Back Panel of #89830 Carrel as shown in illustration # 5.

15. Secure by turning the Cam Locks (C) 1/4 turn until they lock.

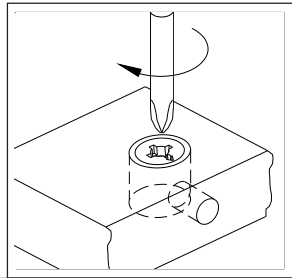

To Secure Cam Locks, Insert Large Phillips Head Screwdriver and turn Cam Lock 1/4 turn (90 degrees) clockwise.

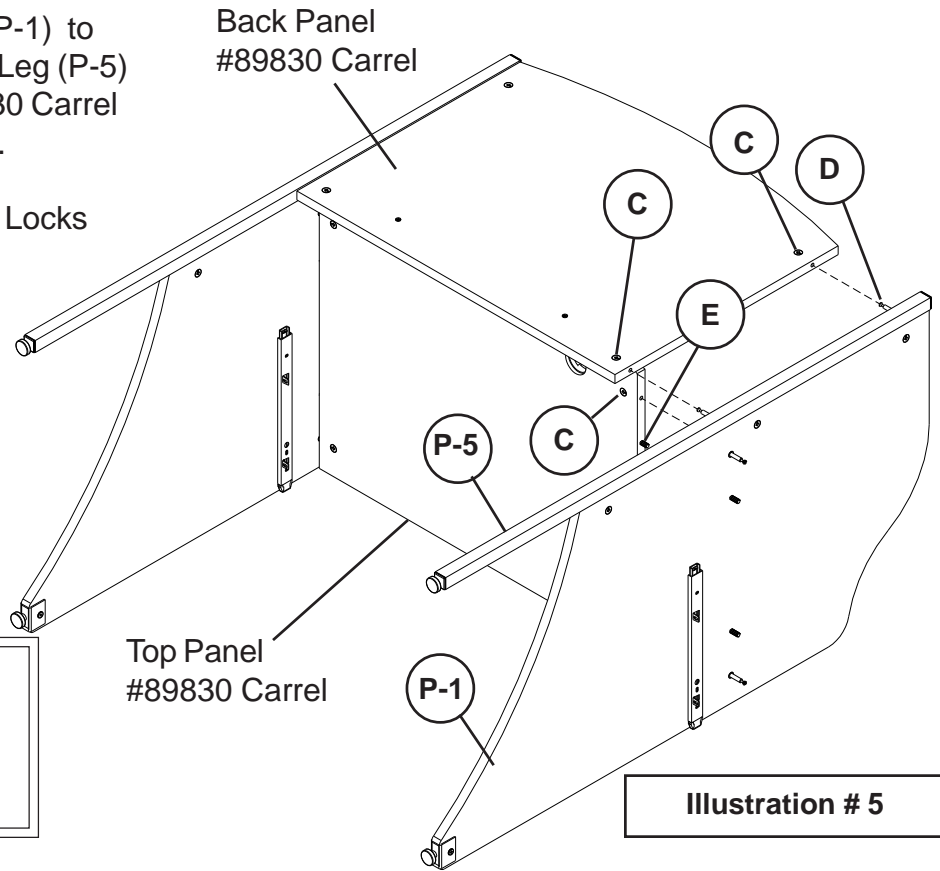

Illustration # 5

16. Slide Top Panel (P-2) over the Wood Dowels (E) and the Camposts (D) in the Middle Side Panel (P-1) as shown in illustration #6. Secure by turning the Cam Locks (C) 1/4 turn until they lock.

17. Slide Back Panel (P-3) over the Camposts (D) in the Middle Leg (P-5) as shown in illustration # 6. Secure by turning the Cam Locks (C) 1/4 turn until they lock.

18. Secure Back Panel (P-3) to Top Panel (P-2) using 2 Wood Screws (A2) as shown in illustration # 6. Tighten Screws using Phillips Screwdriver.

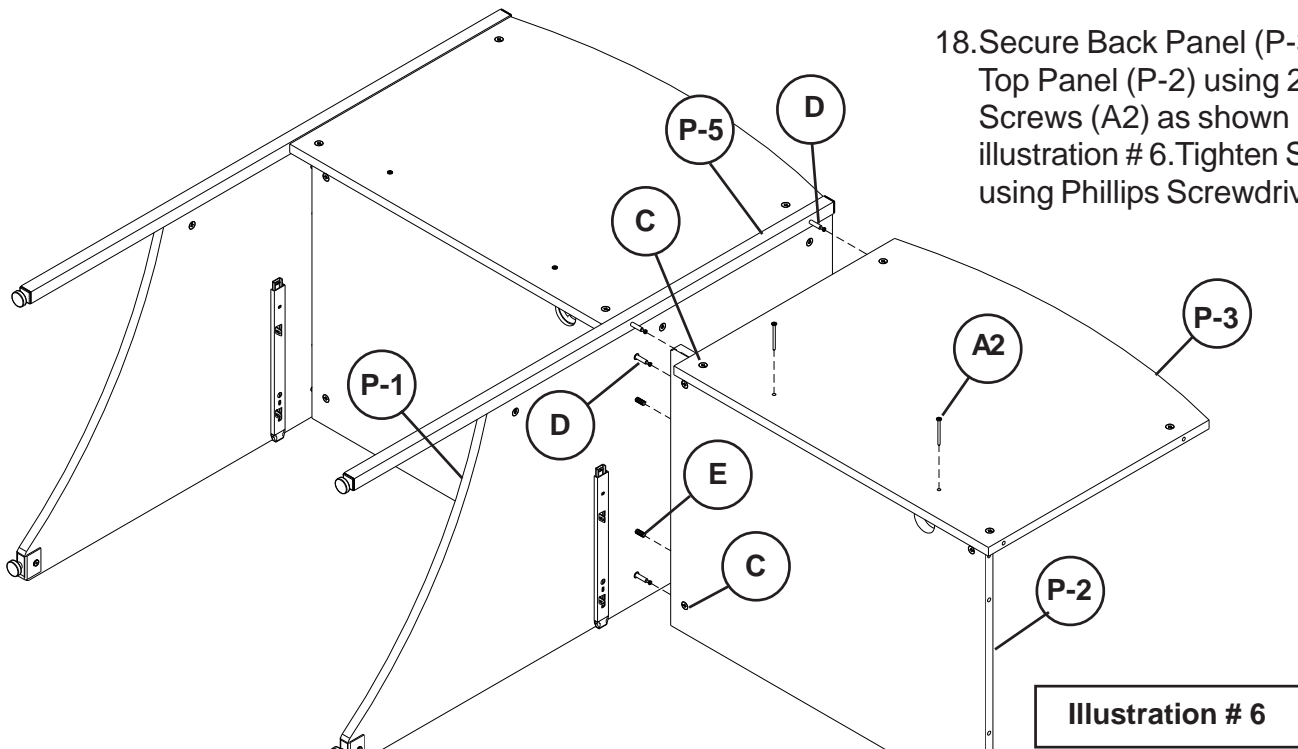
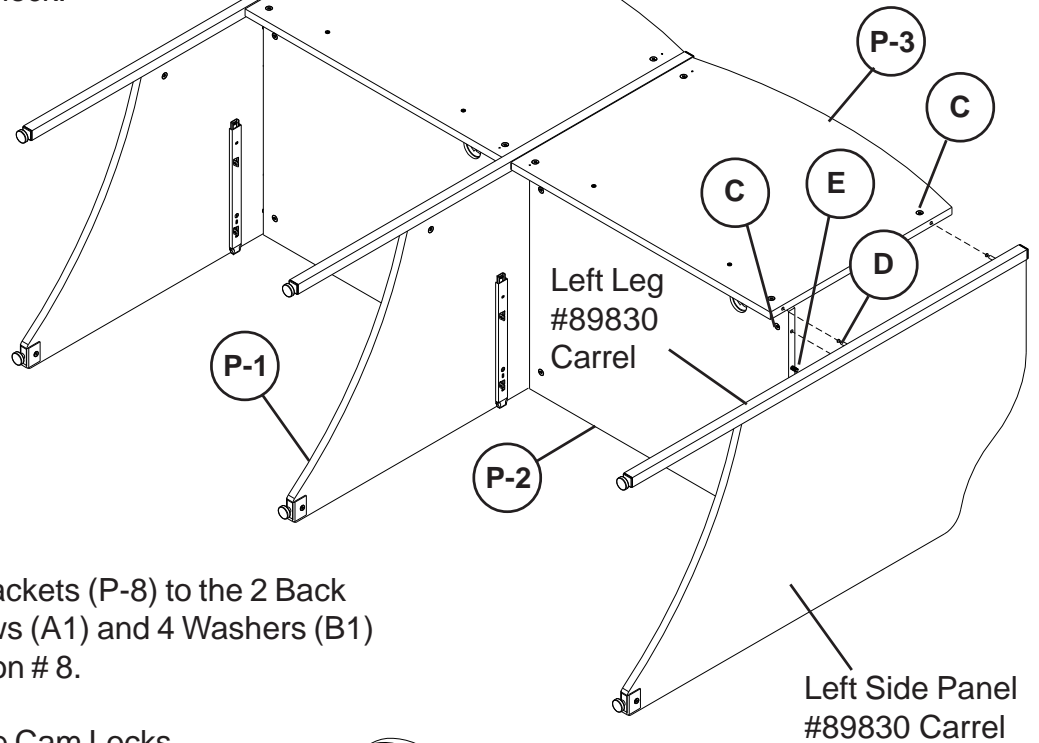

Illustration # 6

19. Attach Left Side Panel and Left Leg from #89830 Carrel to Top Panel (P-2) and Back Panel (P-3) as shown in illustration # 7.

Illustration # 7

20. Secure by turning the Cam Locks (C) 1/4 turn until they lock.



21. Attach 2 Ganging Brackets (P-8) to the 2 Back Panels using 4 Screws (A1) and 4 Washers (B1) as shown in illustration # 8.

22. Secure by turning the Cam Locks (C) 1/4 turn until they lock.

Illustration # 8

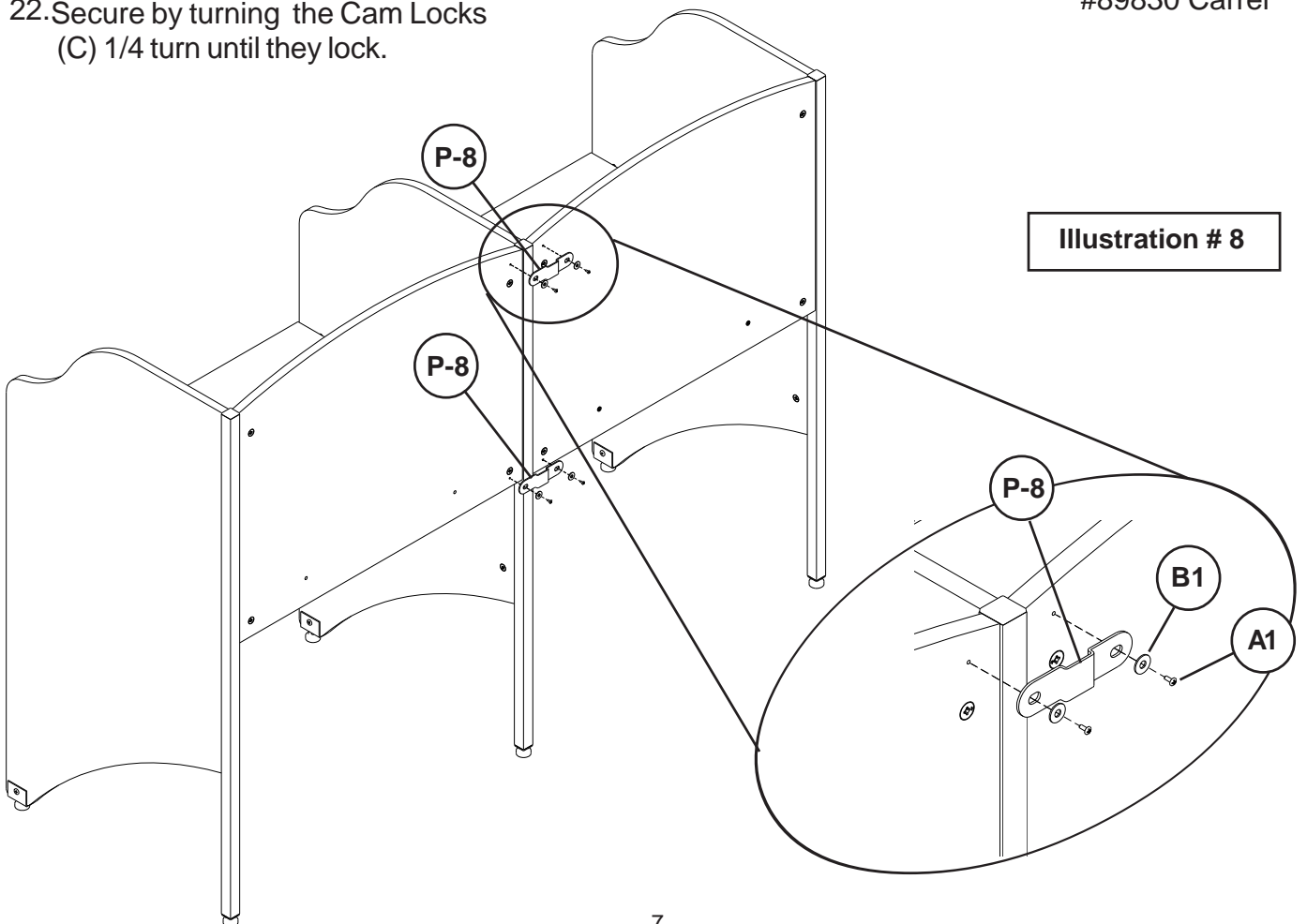

23. Attach 1 Keyboard (P-4) and 1 keyboard from #89830 to Left Keyboard Slides (P-8) and Right Keyboard Slides (P-9) using 4 Wood Screws (A1) and 4 Wood Screws from #89830 as shown in illustration# 9.

24. Tighten Screws (A1) using Phillips Screwdriver.

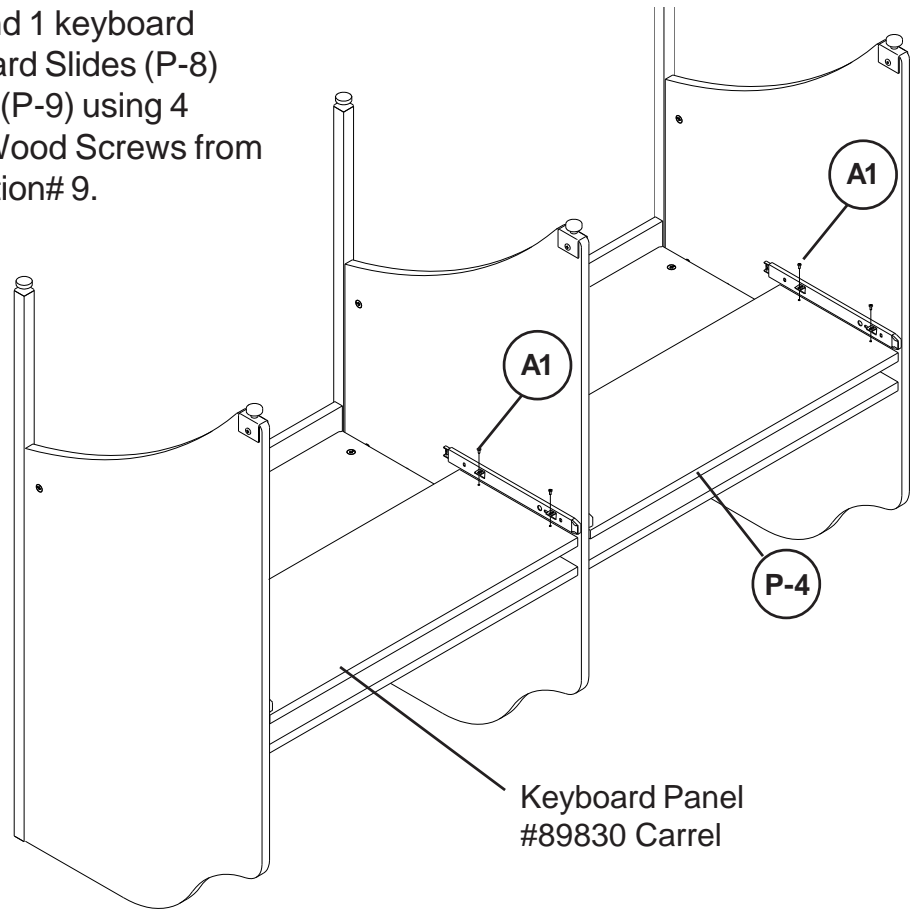
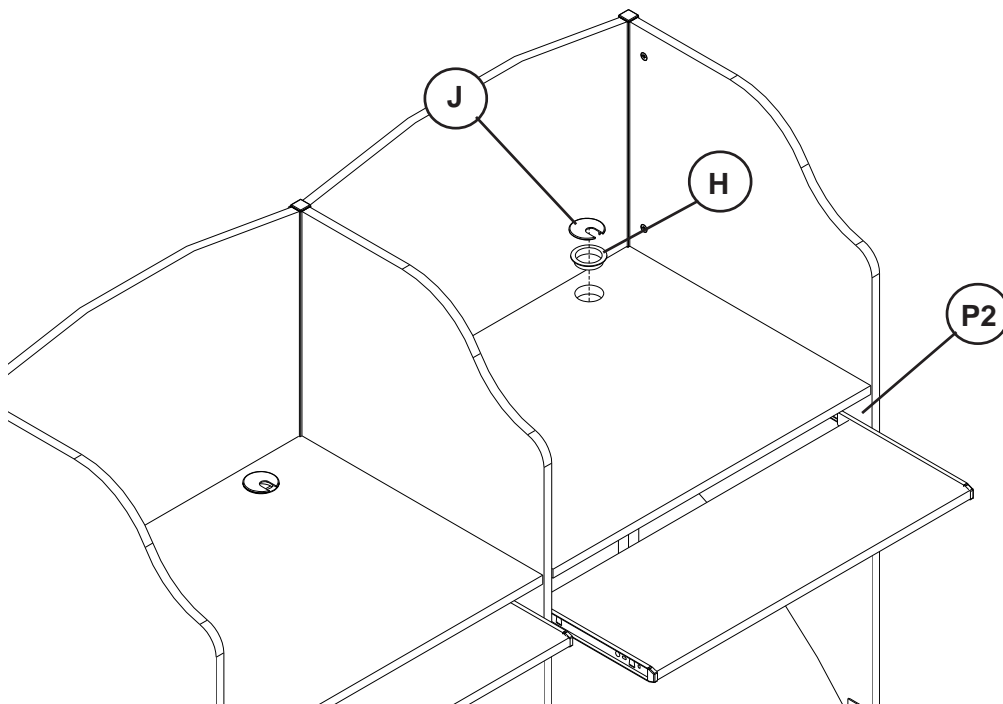

**Illustration # 9**  
**Keyboard Slide Assembly**

To install Grommets:

25. Insert Grommet Sleeve (H) in Round opening in Top Platform (P-2) as shown in illustration #10.

26. Snap Grommet Cap (J) into Grommet Sleeve (H) as shown in illustration #10.



**Grommet installation**  
**Illustration #10**