

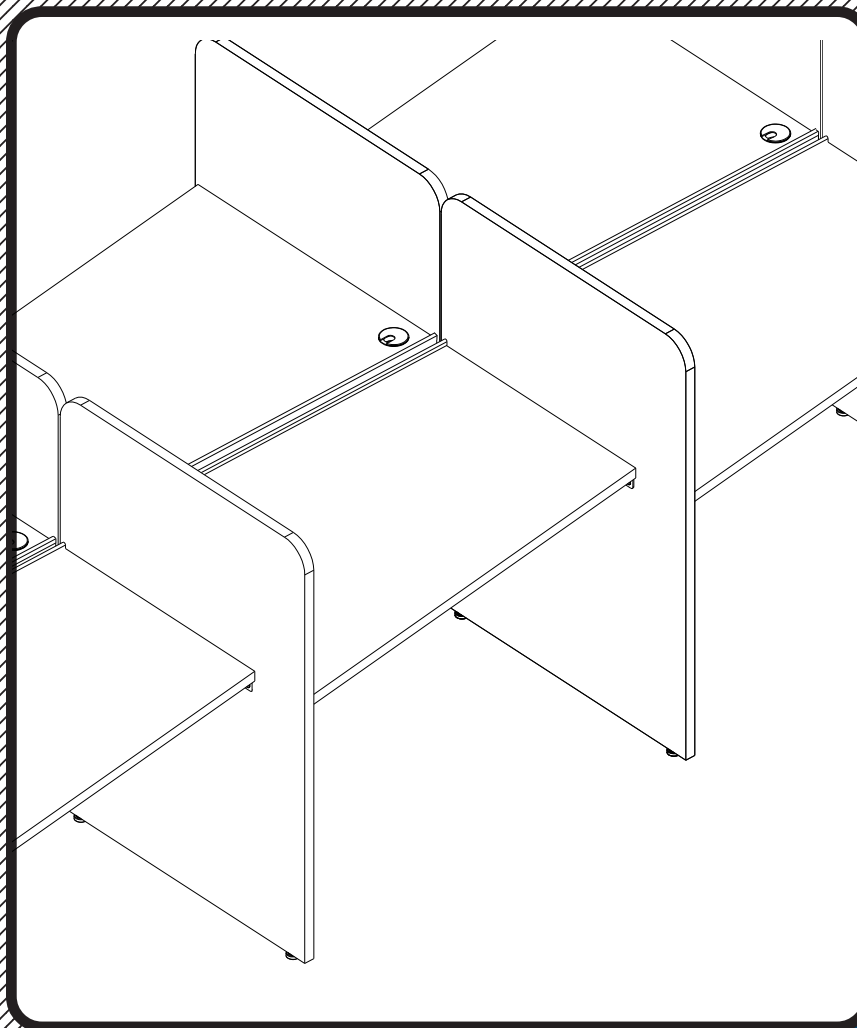











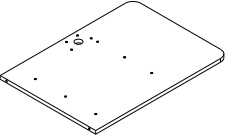

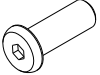



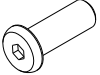

# #89892 Add-on H-Carrel

Computer/Library Workcenter

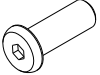

## Assembly Instructions

# #89892 Add-on H-Carrel

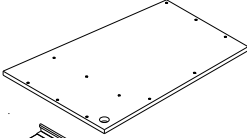
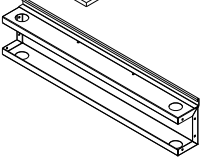
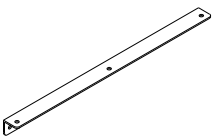
Part	Drawing	Description	Qty	Part	Drawing	Description	Qty																								
P1		Middle Leg	1 EA	<div style="border: 2px solid black; padding: 10px;"> <p style="text-align: center;"><b>Hardware List</b></p> <table border="0"> <tr> <td>A</td> <td></td> <td>Screw M6x15</td> <td>13 EA</td> </tr> <tr> <td>B</td> <td></td> <td>Threaded Post M6</td> <td>7 EA</td> </tr> <tr> <td>C</td> <td></td> <td>Plastic Grommet Sleeve</td> <td>1 EA</td> </tr> <tr> <td>D</td> <td></td> <td>Plastic Grommet Cap</td> <td>1 EA</td> </tr> <tr> <td>E</td> <td></td> <td>Leveling Glide</td> <td>2 EA</td> </tr> <tr> <td>F</td> <td></td> <td>Allen Wrench</td> <td>1 EA</td> </tr> </table> <p style="text-align: center;"><i>We recommend that you assemble this unit on a table.</i></p> <p>Tools required: Adjustable Crescent Wrench</p> </div>				A		Screw M6x15	13 EA	B		Threaded Post M6	7 EA	C		Plastic Grommet Sleeve	1 EA	D		Plastic Grommet Cap	1 EA	E		Leveling Glide	2 EA	F		Allen Wrench	1 EA
A		Screw M6x15	13 EA																												
B		Threaded Post M6	7 EA																												
C		Plastic Grommet Sleeve	1 EA																												
D		Plastic Grommet Cap	1 EA																												
E		Leveling Glide	2 EA																												
F		Allen Wrench	1 EA																												
P2		Top Platform	1 EA																												
P3		Welded cable Tray	1 EA																												
P4		Angle Bracket	2 EA																												

**Missing Parts or UPS Damaged Parts**  
 For Your Convenience you can  
 EMAIL us at  
[moorecoinc.com](mailto:moorecoinc.com)  
 24HOURS 7 DAYS A WEEK

**Should you require assistance during assembly,  
 please call our Customer Service Department  
 Monday - Friday 8 a.m. - 5 p.m.  
 Central Standard Time 1-800-749-2258**

**READ THROUGH INSTRUCTIONS FROM BEGINNING TO END BEFORE STARTING TO ASSEMBLE UNIT.**

**NOTE:**

**Two people are required to assemble this unit.**

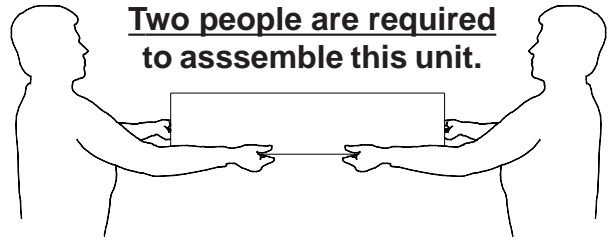

1.) Identify and Separate all the Parts and Hardware.

**Important Information**

Do not use unless all screws are tight. At least every six months, check all screws to be sure they are tight. If parts are missing, broken, damaged, or worn, stop use of the product until repairs are made by your dealer using factory authorized parts.

- 2.) Remove 7 Screws (A) and Right Side Leg From Single H-carrel unit as shown in illustration #1 . Lay Right Side Leg off to the side. You will attach it to the right side of you add-on H-Carrel later.

Single H-carrel unit

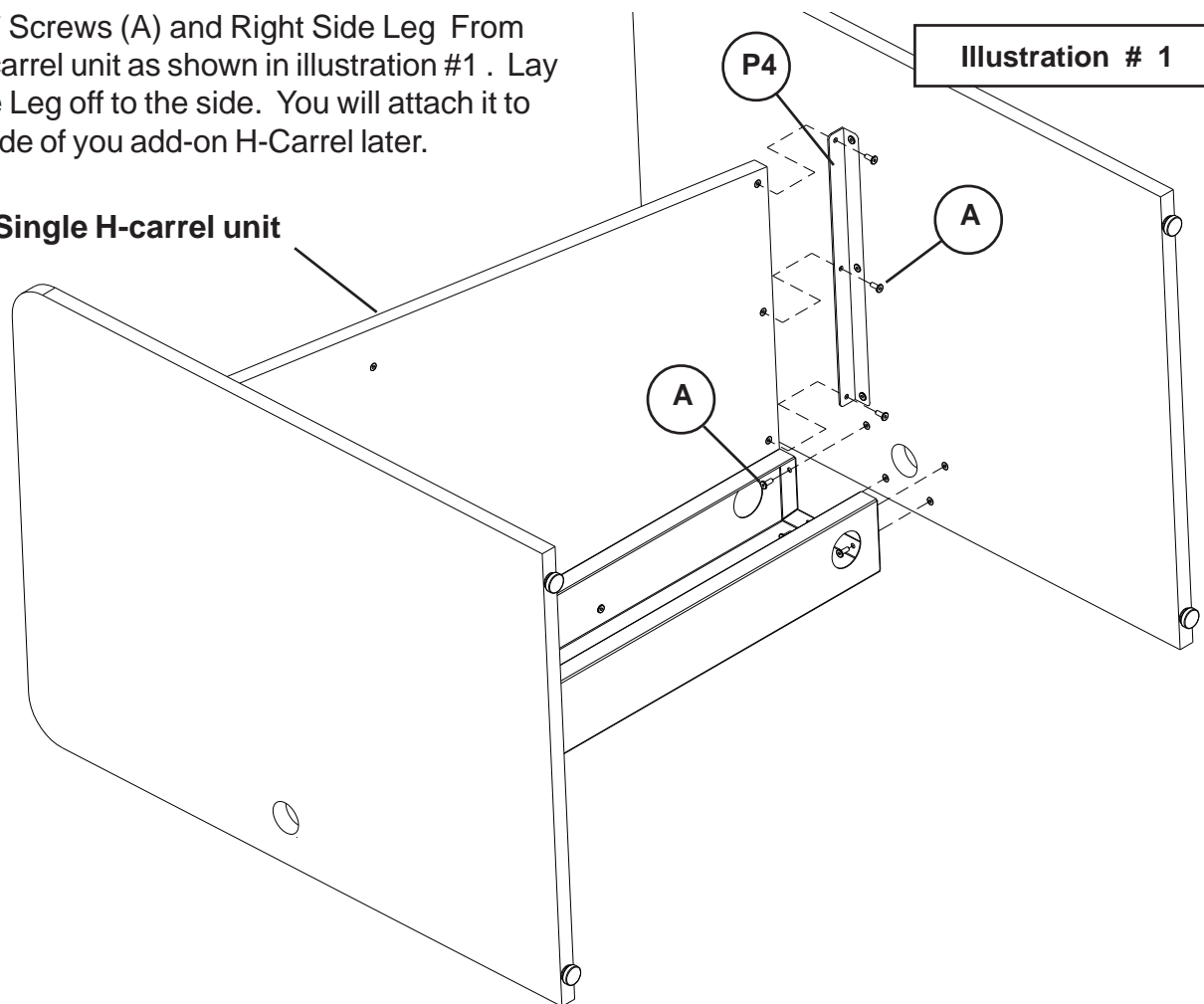

- 3.) Attach 2 Angle Brackets (P4) to Middle Leg (P1) using 3 Screws (A) and 3 Threaded Posts (B) as shown in illustration # 2.

Illustration # 2

- 4.) Attach 2 Leveling Feet (E).

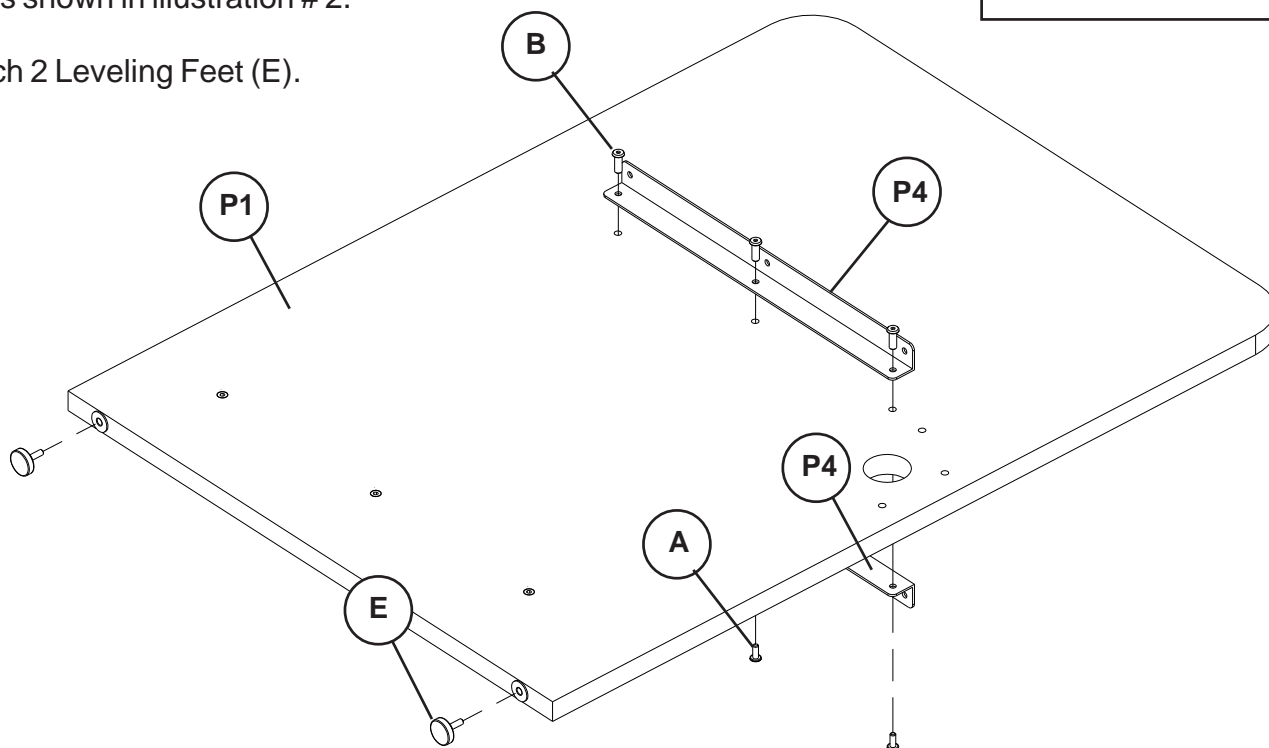

**Illustration # 3**

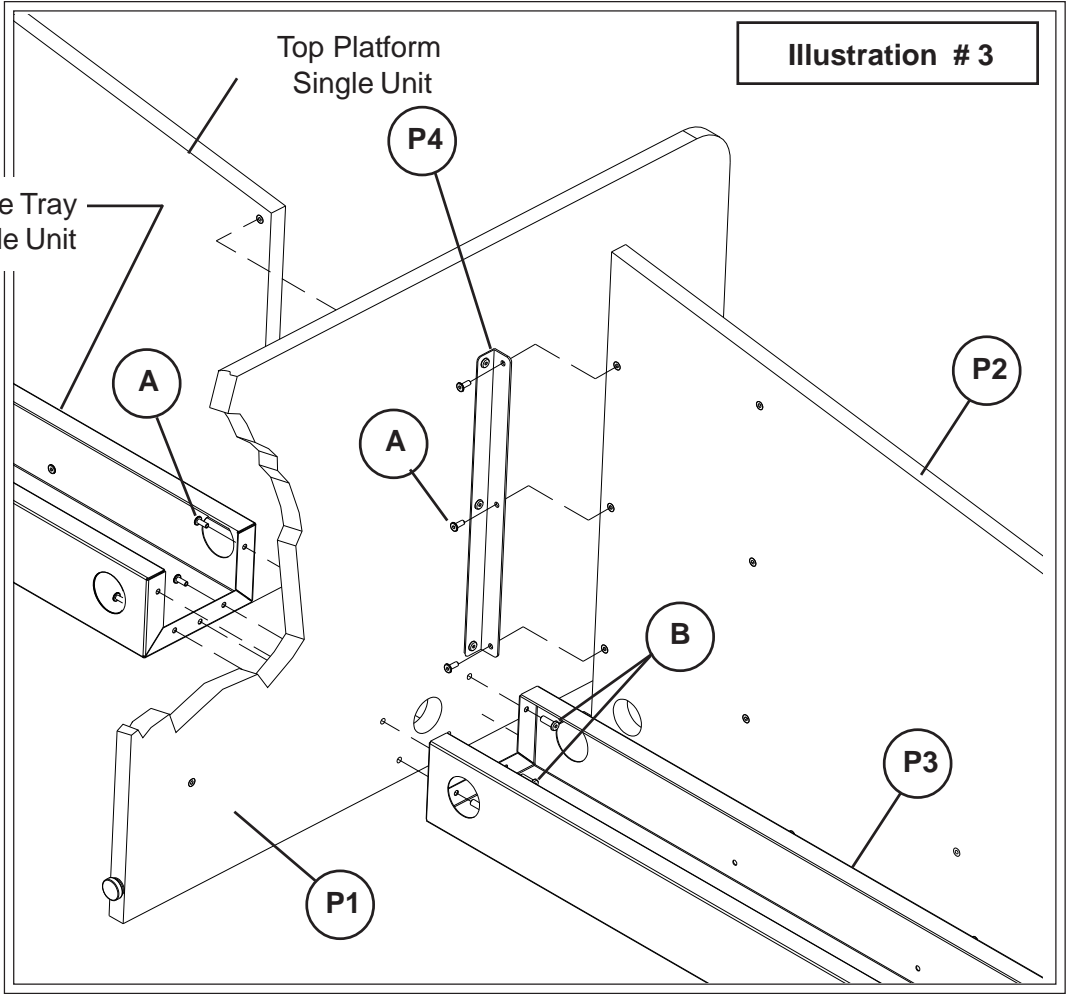

5.) Attach Middle Leg (P-1) to 2 Welded Cable Trays using 4 Screws (A) and 4 Threaded Posts (B) as shown in illustration # 3.

6.) Attach 2 Top Platforms to 2 Angle Brackets (P4) on Middle Leg (P-1) using 6 Screws (A).

7.) Attach Top Platform (P2) and Welded Cable Tray (P-3) to Right Side Leg (From H-Carrel-Single) as shown in illustration # 4.

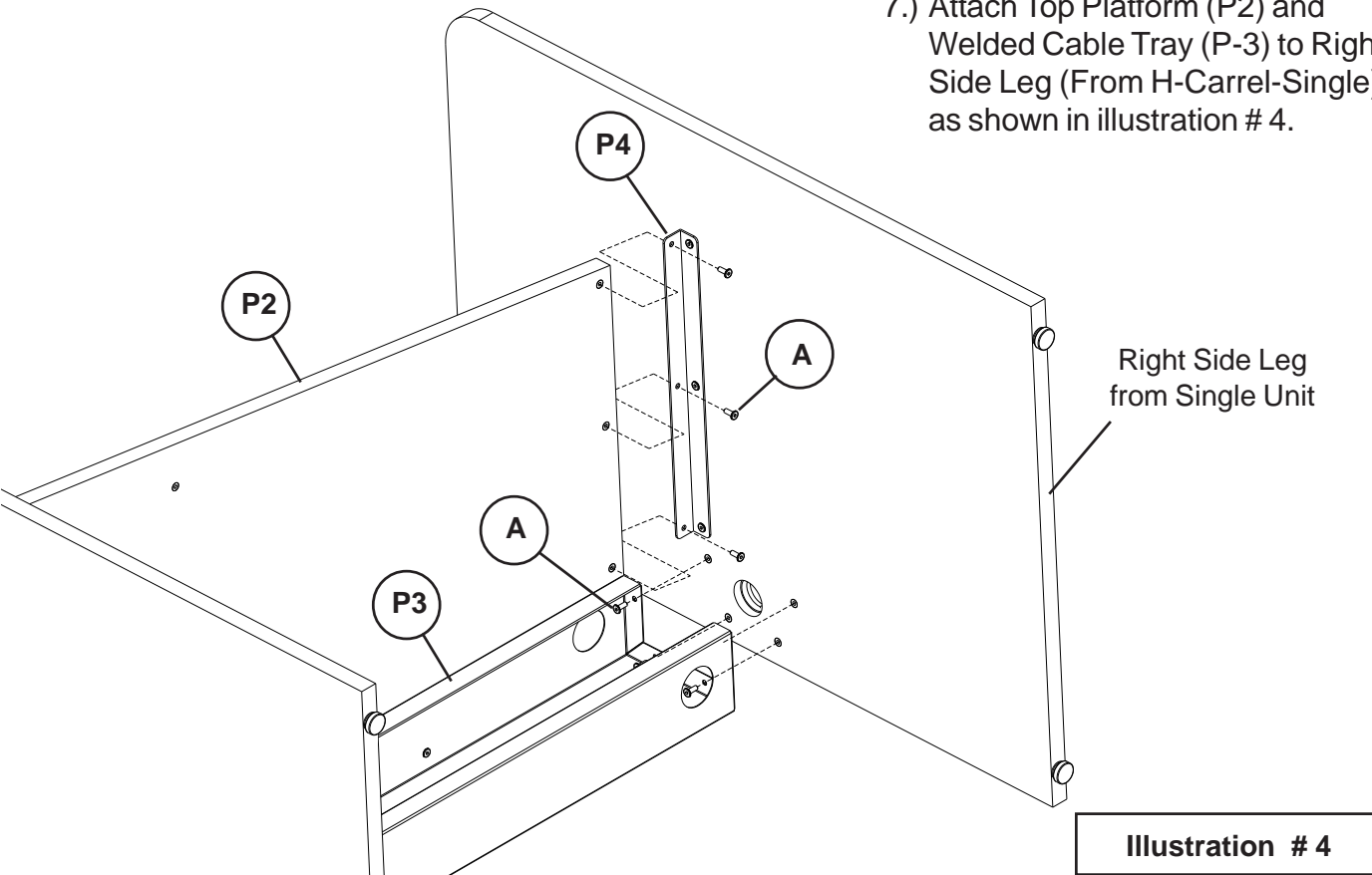

**Illustration # 4**

Illustration # 5

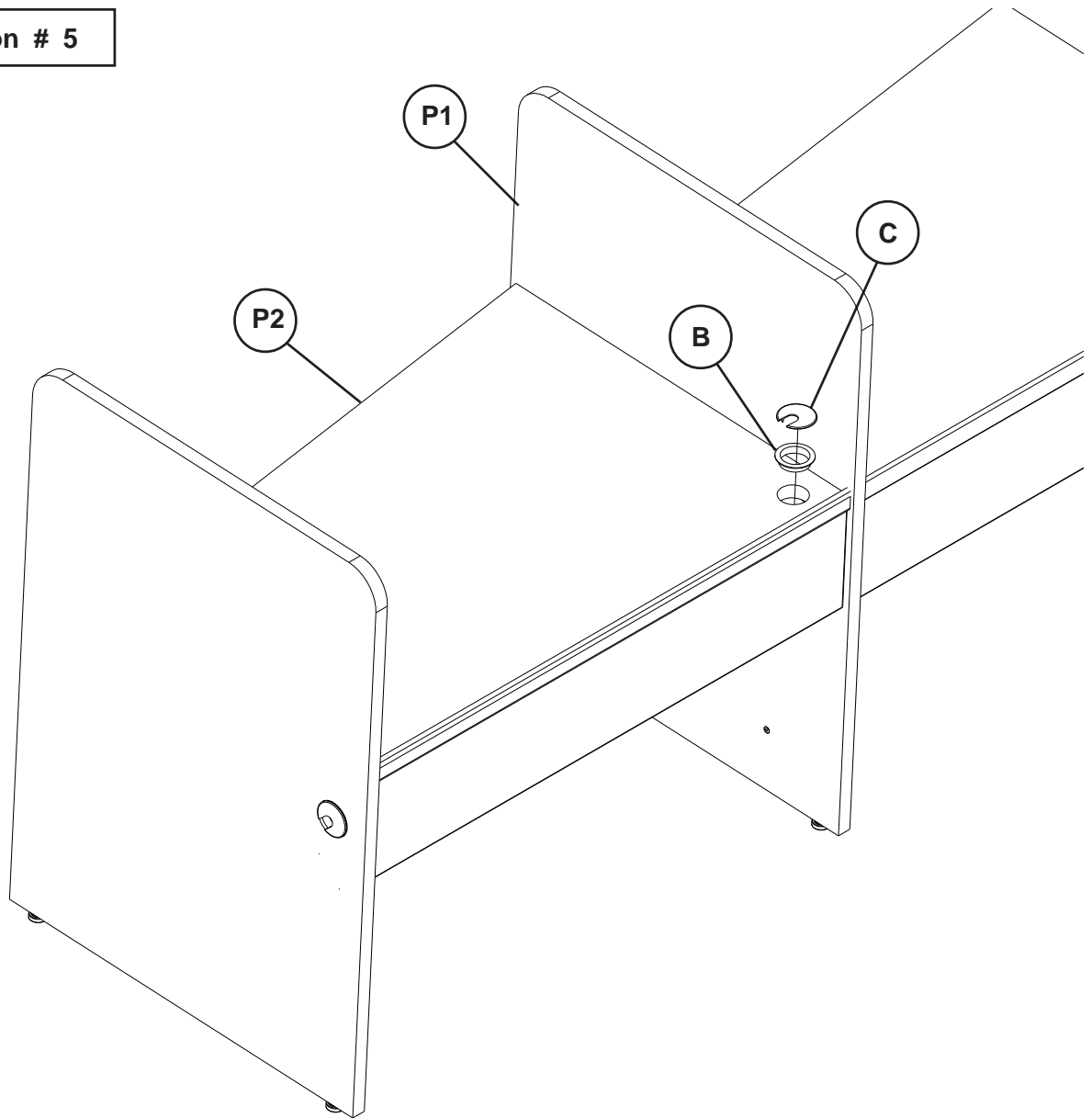

8.) Press Grommet Sleeve (C) in Round opening in Top Platform (P2) as shown in illustration #5.

9.) Snap plastic Cap (D) into Grommet Sleeve (C) as shown in illustration #5.

## Important

The Balt product you have purchased is guaranteed against material and workmanship defects. This guarantee extends 1 year from date of purchase. Should this product fail to function satisfactorily under normal use due to defect or imperfection, the defective part or product will be replaced. Damage caused by common carriers during shipment is not included in this guarantee.

**This guarantee sets forth all applicable guarantees and remedies. No other warranty, expressed or implied shall apply. Failure to follow instructions found in Important Information Section of Owner Sheet shall void the guarantee. Consequential or incidental damages and or costs are not refundable.**