

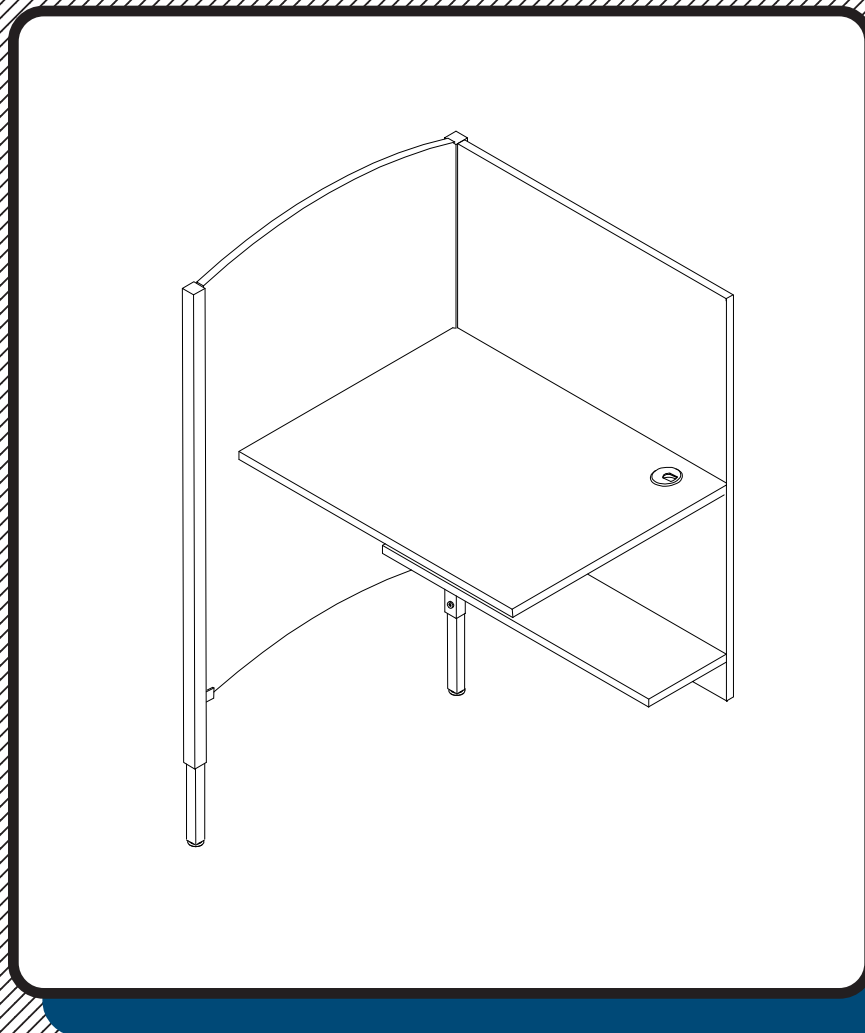









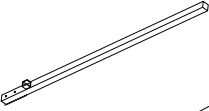
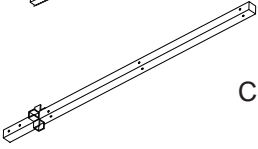

BLT-90300

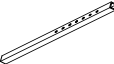
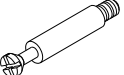
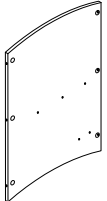
Add-On Adjustable Height Carrel

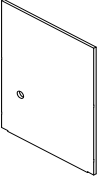

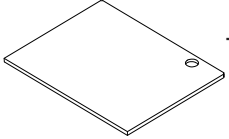
Assembly Instructions

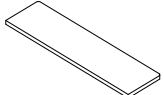
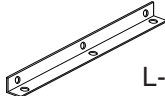
Add-On Adjustable Height Carrel

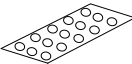
Part	Drawing	Description	Qty	Part	Drawing	Description	Qty
P-1		Front Upper Leg	1 EA	Hardware List			
P-2		Center Back Upper Leg	1 EA	A		Screw M6X15mm Pan Hd	19 EA
P3-1		Insert Leg-Short	2 EA	A1		Tapped Rivet	5 EA
P3-2		Insert Leg-Long	2 EA	B		Campost	12 EA
P-4		Center Wing Panel	1 EA	C		Allen Wrench	1 EA
P-5		Back Panel	1 EA	D		Cam	12 EA
P-6		Top Panel	1 EA	E		L- Brace Short	2 EA
P-7		Shelf	1 EA	F		L-Brace Long	2 EA
				G		Grommet	2 EA
				H		Glides	2 EA
				I		Stick-On Covers	1 Sheet

Adjustable Height Carrel Assembly Instructions

1.) Identify and Separate all the Parts and Hardware.

NOTE: Choose Insert Legs (P4-1) for Carrel Heights 27"-35" or
Choose Insert Legs (P4-2) for Carrel Heights 31"-39".

2.) Screw in a Glide (H) into the bottom of the Insert Leg . Place an Insert Leg into the Front Upper Leg (P-1) and secure at the height you want using two Screws (A) as shown in illustration #1. Tighten Screws(A) with Allen Wrench (C). Screw in three Camposts (B) into the Front Upper Leg (P-1).

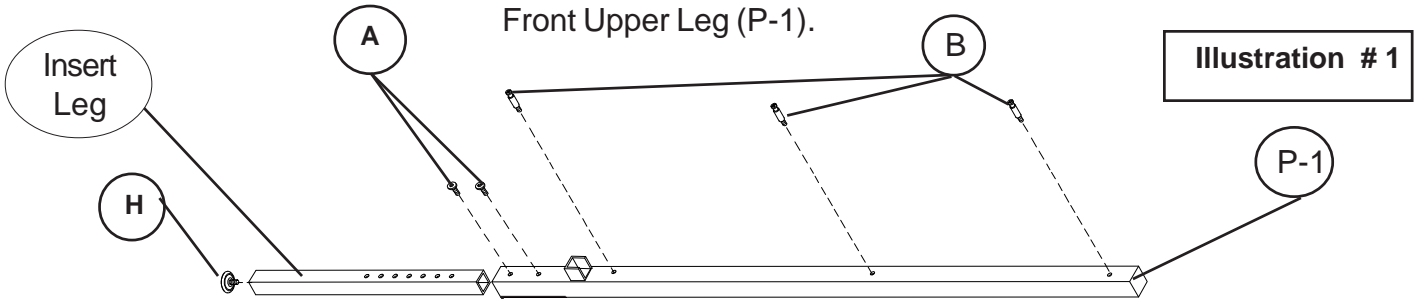

3.) Screw in a Glide (H) into the bottom of one Insert Leg . Place the Insert Leg into the bottom of the Center Back Upper Leg (P-2) and secure at the same height as the Front Leg using two Screws (A) as shown in illustration #2. Tighten Screws (A) with Allen Wrench (C). Screw in nine Camposts (B) into the Center Back Upper Leg (P-2).

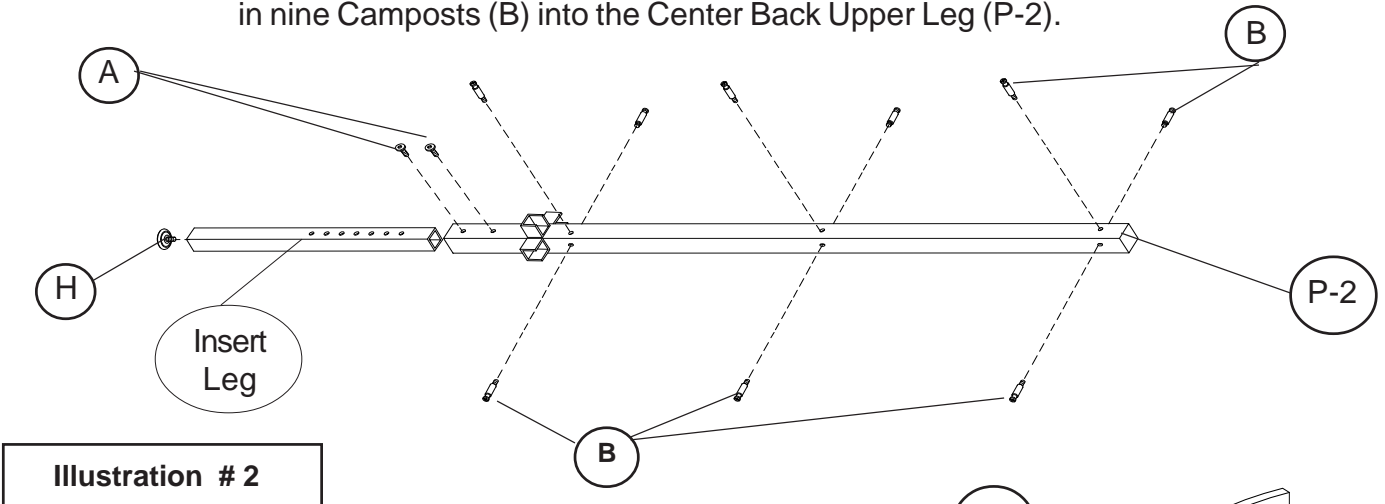

4.) Attach two L-Braces Long (F) to each side of the Center Wing Panel (P-4) using three Screws (A) and three Taped Rivets (A-1). Atch two L-Brace Short (E) to each side of the Center WingPanel (P-5) using two Screws (A) and two Taped Rivets (A-1) as shown in illustration #3.

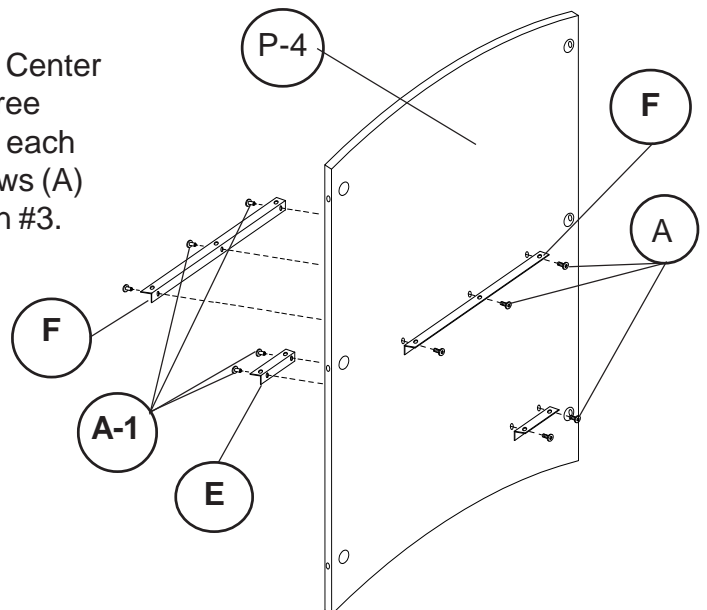

5.) Insert six Cams (D) into the large predrilled holes on the Center Wing Panel (P-4). Make sure the arrow on the Cam is pointed to the small hole connecting hole in the edge. Insert the Front Leg's Camposts (B) into the small holes in the edge of Center Wing Panel (P-4) and turn the Cams 90 degrees clockwise to lock in place. Repeat this step for the Center Back Leg assembly as shown in illustration #4.

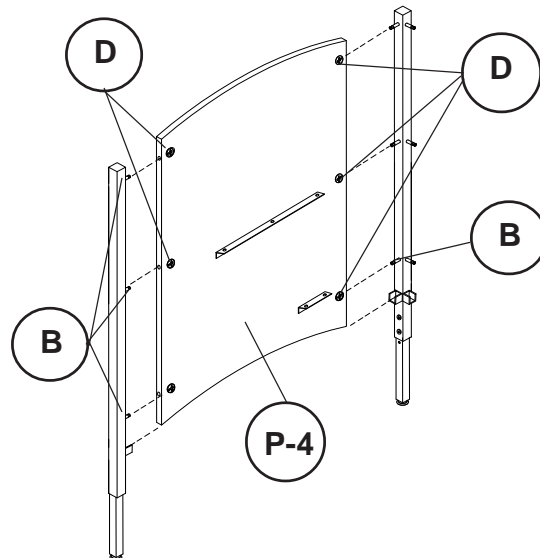

Illustration # 4

6.) Place the Center Wing Panel assembly on the right side of the Starter Carrel assembly as shown in illustration #5. Insert the Camposts (B) that are on the left side of the Center Back Upper Leg assembly into the holes on the edge of the Starter's Back Panel. Turn the Cams (D) 90 degrees to lock. Secure the Starter's Top Panel (P-8) to the L-Brace Long (F) on the Add-On using three Screws (A). Secure the Starter's Shelf (P-9) to the L-Brace Short (E) on the Center Wing Panel assembly using two Screws (A).

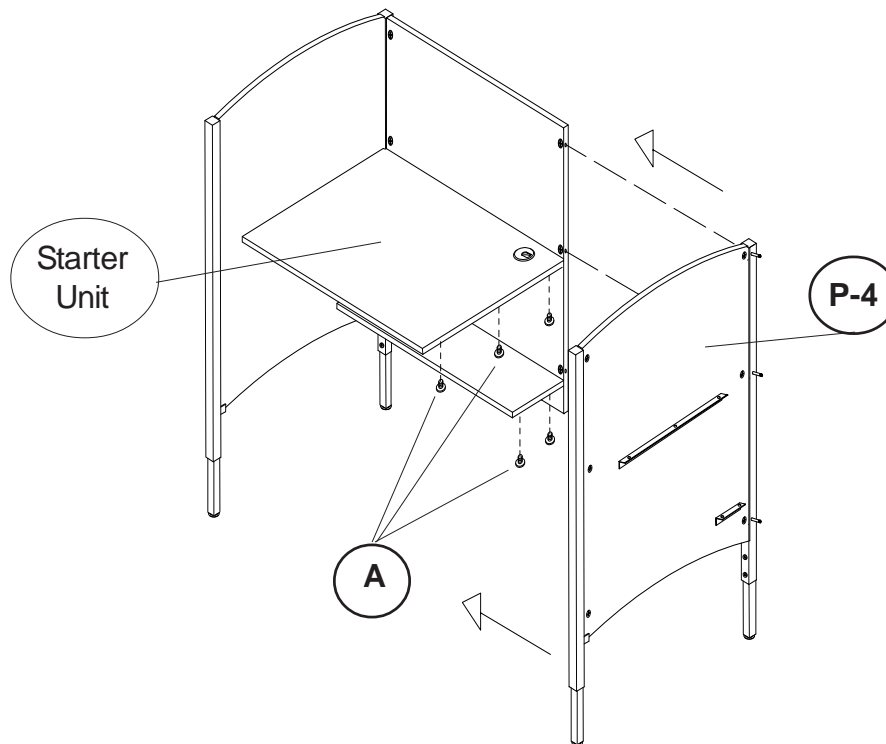

Illustration # 5

7.) Insert 6 Cams (D) into the drilled Cam holes in the Back Panel (P-5). Make sure the arrow on each Cam (D) is pointed to the small connecting hole in the edge. Insert the Center Back Leg's Camposts (B) into the small edge holes in the Back Panel (P-5) and turn the Cams 90 degrees to lock the leg in place. Repeat this Step to install the Right Wing Panel assembly that was removed from the Starter carrel to the Add-On's Back Panel. See illustration #6.

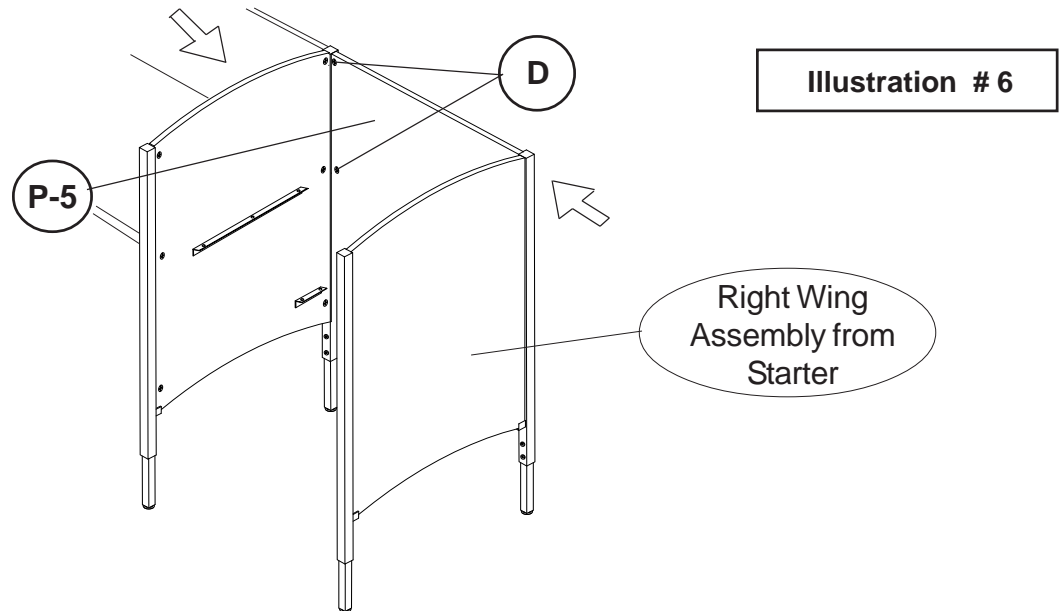

Illustration # 6

8.) Slide the Top Panel (P-6) and the Shelf (P-7) in between the Center Wing Panel (P-4) and the Right Wing Panel from the Starter. Slide the Top Panel on top of the two L-Braces Long (F) and attach using six Screws (A). Slide the Shelf (P-7) on top of the two L-Braces Short (E) and attach from underneath using four Screws (A).

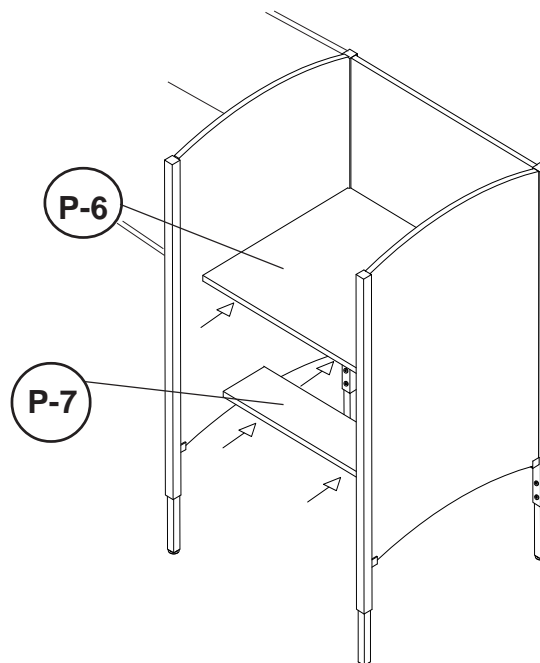

Illustration # 7

9.) Push in the Grommets (G) into the Top Panel (P-6) cut-out and in the Back Panel (P-5) cut-out. Use the Stick-On Dots (I) to cover the Cams (D). See illustration #8.

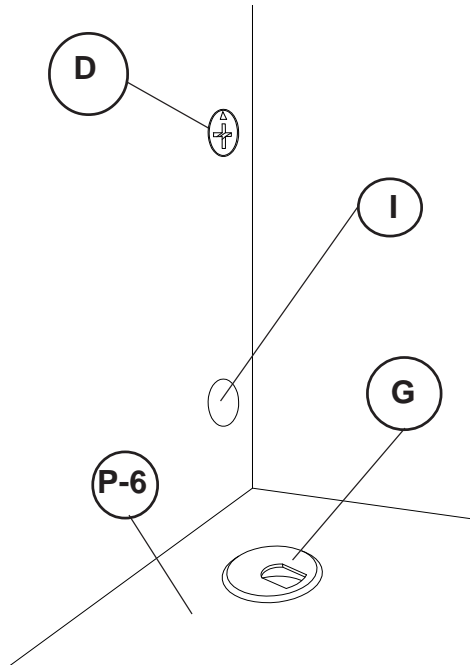

Illustration # 8

BLT-90300

Add-On Adjustable Height Carrel

