



User Instruction Manual for:
Saflok® Toggle Anchor
(Model Number: 2100101)

USER INSTRUCTION MANUAL **SAFLOK® TOGGLE ANCHOR**

This manual is intended to meet the Manufacturer's Instructions as required by ANSI Z359.1 and should be used as part of an employee training program as required by OSHA.

WARNING: This product is part of a personal fall arrest, restraint, work positioning, personnel riding, or rescue system. The user must follow the manufacturer's instructions for each component of the system. These instructions must be provided to the user of this equipment. The user must read and understand these instructions before using this equipment. Manufacturer's instructions must be followed for proper use and maintenance of this equipment. Alterations or misuse of this equipment, or failure to follow these instructions, may result in serious injury or death.

IMPORTANT: If you have questions on the use, care, or suitability of this equipment for your application contact Capital Safety.

IMPORTANT: Record the product identification information from the ID label in the Inspection and Maintenance Log in Section 9.0 of this manual.

DESCRIPTION

The Saflok® Toggle Anchor (Figure 1) is a reusable anchor point for horizontal, vertical, or overhead applications. The Toggle Anchor is designed for use in precast concrete, precast hollow-core concrete, or a steel flange. After insertion through a 3/4 in. (19.05 mm) mounting hole, the Toggle rotates perpendicular to the mounting hole to secure the Toggle Anchor. Squeezing the Swivel Ring and Hole Plug together compresses the Spring and rotates the Toggle for immediate removal from the mounting hole.

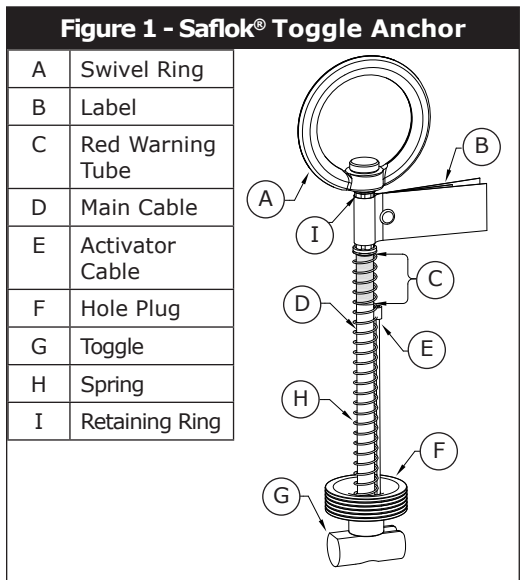
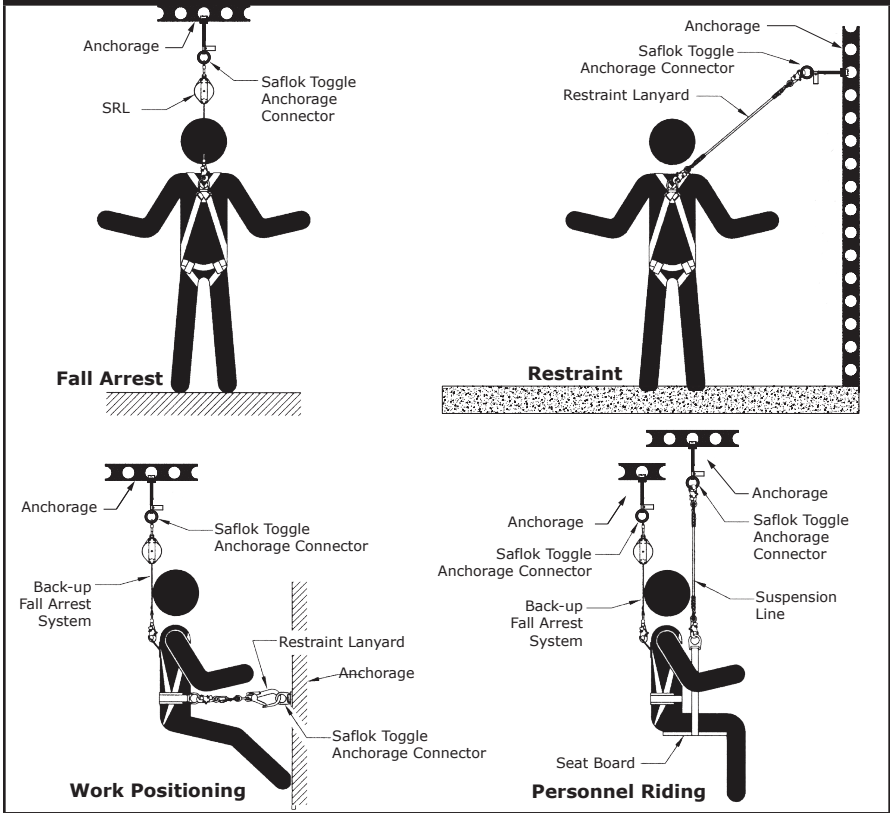

Figure 2 - Applications



1.0 APPLICATIONS

1.1 PURPOSE: The Saflok® Toggle Anchor is designed for use as an anchorage attachment point for a personal fall arrest system, work positioning system, personnel riding system, or rescue system. See Figure 2 for application illustrations.

- A. PERSONAL FALL ARREST:** The Toggle Anchor is used as a component of a personal fall arrest system to protect the user in the event of a fall. Personal fall arrest systems typically include a full body harness and a connecting subsystem (energy absorbing lanyard). Maximum permissible free fall is 6 feet.
- B. RESTRAINT:** The Toggle Anchor is used as a component of a restraint system to prevent the user from reaching a fall hazard. Restraint systems typically include a full body harness and a lanyard or restraint line. No vertical free fall is permitted.

- C. WORK POSITIONING:** The Toggle Anchor is used as a component of a work positioning system to support the user at a work position. Work positioning systems typically include a full body harness, positioning lanyard, and a back-up personal fall arrest system. Maximum permissible free fall is 2 feet.
- D. PERSONNEL RIDING:** The Toggle Anchor is used as a component of a personnel riding system to suspend or transport the user vertically. Personnel riding systems typically include a full body harness, boatswains’s chair or seat board, and a back-up personal fall arrest system. No vertical free fall is permitted.
- E. RESCUE:** The Toggle Anchor is used as a component of a rescue system. Rescue systems are configured depending on the type of rescue. No vertical free fall is permitted.

1.2 LIMITATIONS: The following application limitations must be recognized and considered before using this product:

- A. CAPACITY:** The Toggle Anchor is designed for use by persons with a combined weight (clothing, tools, etc.) of no more than 310 lbs. No more than one personal protective system may be connected at one time.

NOTE: *For emergency rescues it may be acceptable to connect more than one system if the anchorage will support the anticipated loads.*

- B. FREE FALL:** Personal fall arrest systems used with this equipment must be rigged to limit the free fall to 6 feet (ANSI Z359.1). See the personal fall arrest system manufacturer’s instructions for more information. Restraint systems must be rigged so that no vertical free fall is possible. Work positioning systems must be rigged so that free fall is limited to 2 feet or less. Personnel riding systems must be rigged so that no vertical free fall is possible. Rescue systems must be rigged so that no vertical free fall is possible.
- C. FALL CLEARANCE:** There must be sufficient clearance below the user to arrest a fall before the user strikes the ground or other obstruction. The clearance required is dependent on the following factors:

- Deceleration Distance
- Free Fall Distance
- Worker Height
- Movement of Harness Attachment Element
- Elevation of D-Ring Anchorage Connector
- Connecting Subsystem Length

See the personal fall arrest system manufacturer’s instructions for more information.

- D. SWING FALLS:** Swing falls occur when the anchorage point is not directly above the point where a fall occurs. See Figure 3. The force of striking an object in a swing fall may cause serious injury or death. Minimize swing falls by working as close to the anchorage point as possible. Do not permit a swing fall if injury could occur. Swing falls will significantly increase the clearance required when a self retracting lifeline or other variable length connecting subsystem is used.

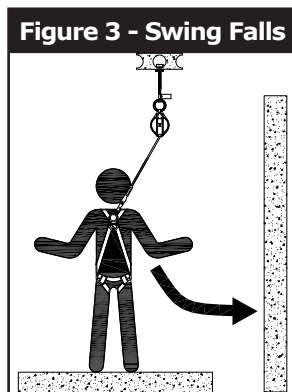

- E. ENVIRONMENTAL HAZARDS:** Use of this equipment in areas with environmental hazards may require additional precautions to prevent injury to the user or damage to the equipment. Hazards may include, but are not limited to: heat, chemicals, corrosive environments, high voltage power lines, gases, moving machinery, and sharp edges. Contact DBI-SALA if you have questions about using this equipment where environmental hazards exist.
- F. TRAINING:** This equipment must be installed and used by persons trained in its correct application and use. See section 4.0.

- 1.3 APPLICABLE STANDARDS:** Refer to national standards including; ANSI Z359 (.0, .1, .2, .3, and .4) fall protection standards, ANSI A10.32, and local, state, and federal (OSHA) requirements governing occupational safety for additional information regarding personal fall arrest systems and associated components.

2.0 SYSTEM REQUIREMENTS

- 2.1 COMPATIBILITY OF COMPONENTS:** DBI-SALA equipment is designed for use with DBI-SALA approved components and subsystems only. Substitutions or replacements made with non-approved components or subsystems may jeopardize compatibility of equipment and may effect the safety and reliability of the complete system.
- 2.2 COMPATIBILITY OF CONNECTORS:** Connectors are considered to be compatible with connecting elements when they have been designed to work together in such a way that their sizes and shapes do not cause their gate mechanisms to inadvertently open regardless of how they become oriented. Connectors (hooks, carabiners, and D-rings) must be capable of supporting at least 5,000 lbs. (22 kN). Connectors must be compatible with the anchorage or other system components. See Section 3.8 for additional information on anchorage connections. Do not use equipment that is not compatible. Non-compatible connectors

may unintentionally disengage (see Figure 4). Connectors must be compatible in size, shape, and strength. Self-locking snap hooks and carabiners are required by ANSI Z359.1 and OSHA.

Figure 4 - Unintentional Disengagement (Rollout)

If the connecting element to which a snap hook (shown) or carabiner attaches is undersized or irregular in shape, a situation could occur where the connecting element applies a force to the gate of the snap hook or carabiner. This force may cause the gate (of either a self-locking or a non-locking snap hook) to open, allowing the snap hook or carabiner to disengage from the connecting point.

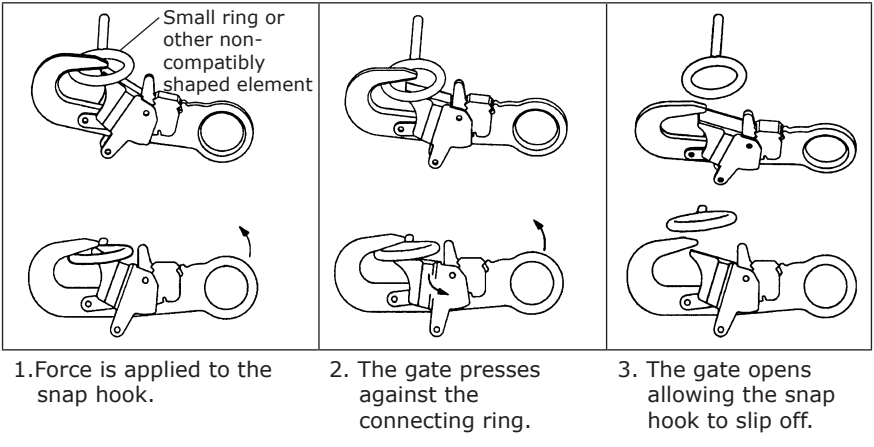

2.3 MAKING CONNECTIONS: Use only self-locking snap hooks and carabiners with this equipment. Only use connectors that are suitable to each application. Ensure all connections are compatible in size, shape and strength. Do not use equipment that is not compatible. Ensure all connectors are fully closed and locked.

DBI-SALA connectors (snap hooks and carabiners) are designed to be used only as specified in each product's user's instructions. See Figure 5 for inappropriate connections. DBI-SALA snap hooks and carabiners should not be connected:

- A. To a D-ring to which another connector is attached.
- B. In a manner that would result in a load on the gate.

NOTE: Other than 3,600 lb. (16 kN) gated hooks, large throat opening snap hooks should not be connected to standard size D-rings or similar objects which will result in a load on the gate if the hook or D-ring twists or rotates. Large throat snap hooks are designed for use on fixed structural elements such as rebar or cross members that are not shaped in a way that can capture the gate of the hook.

Figure 5 - Inappropriate Connections

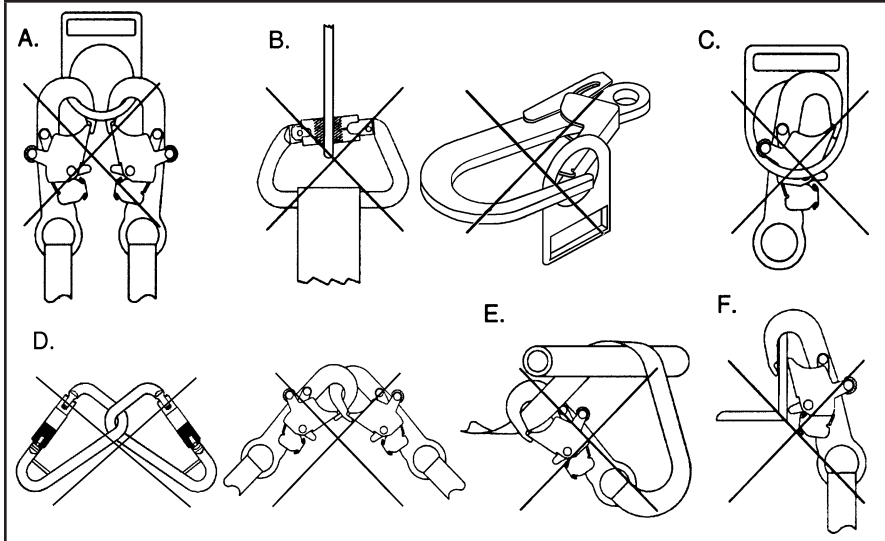

- C. In a false engagement, where features that protrude from the snap hook or carabiner catch on the anchor and without visual confirmation seems to be fully engaged to the anchor point.
- D. To each other.
- E. Directly to webbing or rope lanyard or tie-back (unless the manufacturer's instructions for both the lanyard and connector specifically allow such a connection).
- F. To any object which is shaped or dimensioned such that the snap hook or carabiner will not close and lock, or that roll-out could occur.

2.4 PERSONAL FALL ARREST SYSTEM: Personal fall arrest systems used with this equipment must meet applicable state, federal, OSHA, and ANSI requirements. A full body harness must be worn when this equipment is used as a component of a personal fall arrest system. As required by OSHA, the personal fall arrest system must be capable of arresting the user's fall with a maximum arresting force of 1,800 lbs., and limit the free fall to 6 feet or less. If the maximum free fall distance must be exceeded, the employer must document, based on test data, that the maximum arresting force will not be exceeded, and the personal fall arrest system will function properly.

When a free fall greater than 6 feet, and up to a maximum of 12 feet is possible, DBI-SALA recommends using a personal fall arrest system incorporating a DBI-SALA Force2 Energy Absorbing Lanyard. DBI-SALA has performed testing using the Force2 Energy Absorbing Lanyard in free falls up to 12 feet to ensure the maximum arresting force does not exceed 1,800 lbs., and the

system functions properly. The results of these tests are listed in the user instruction manual provided with Force2 Energy Absorbing Lanyards.

2.5 RESTRAINT SYSTEM: Restraint systems used with this equipment must meet state, federal, OSHA, and ANSI requirements.

2.6 ANCHORAGE STRENGTH: The anchorage strength required is dependent on the application type. The following are the requirements of ANSI Z359.1 for these application types:

A. Fall Arrest: Anchorages selected for fall arrest systems shall have a strength capable of sustaining static loads applied in the directions permitted by the system of at least:

1. 5,000 lbs. (22.2 kN) for non-certified anchorages
2. Two times the maximum arresting force for certified anchorages.

When more than one fall arrest system is attached to an anchorage, the strengths set forth in (1) and (2) above shall be multiplied by the number of systems attached to the anchorage.

B. Restraint: Anchorages selected for restraint and travel restraint systems shall have a strength capable of sustaining static loads applied in the directions permitted by the system of at least:

1. 1,000 lbs. (4.5 kN) for non-certified anchorages
2. Two times the foreseeable force for certified anchorages.

When more than one restraint and travel restraint system is attached to an anchorage, the strengths set forth in (1) and (2) above shall be multiplied by the number of systems attached to the anchorage.

C. Work Positioning: Anchorages selected for work positioning systems shall have a strength capable of sustaining static loads applied in the directions permitted by the system of at least:

1. 3,000 lbs. (13.3 kN) for non-certified anchorages
2. Two times the foreseeable force for certified anchorages.

When more than one work positioning system is attached to an anchorage, the strengths previously set forth in (1) and (2) shall be multiplied by the number of systems attached to the anchorage.

D. Rescue: Anchorages selected for rescue systems shall have a strength capable of sustaining static loads applied in the

directions permitted by the system of at least:

1. 3,000 lbs. (13.3 kN) for non-certified anchorages
2. Five times the foreseeable force for certified anchorages.

When more than one work positioning system is attached to an anchorage, the strengths previously set forth in (1) and (2) shall be multiplied by the number of systems attached to the anchorage.

- E. PERSONNEL RIDING:** The structure to which the Concrete Wedge Anchor is attached must sustain static loads applied in the directions permitted by the personnel riding system of at least 2,500 lbs. When more than one personnel riding system is attached to an anchorage, the strengths stated above must be multiplied by the number of personnel riding systems attached to the anchorage.

WARNING: Use of the Toggle Anchor for an application that does not meet the anchorage strength requirements stated in this section may result in serious injury or death.

3.0 INSTALLATION AND USE

WARNING: Do not alter or intentionally misuse this equipment. Consult Capital Safety when using this equipment in combination with components or subsystems other than those described in this manual. Some subsystem and component combinations may interfere with the operation of this equipment. Use caution when using this equipment around moving machinery, electrical hazards, chemical hazards, sharp edges, and abrasive surfaces.

WARNING: Consult your doctor if there is any reason to doubt your fitness to safely absorb the shock from a fall arrest or suspension. Age and fitness seriously affect a worker's ability to withstand falls. Pregnant women or minors must not use DBI-SALA equipment unless in an emergency situation.

3.1 BEFORE EACH USE: Before each use of this equipment, carefully inspect it to assure that it is in serviceable condition. Refer to section 5.0 for inspection details. Do not use if inspection reveals an unsafe condition.

3.2 PLANNING: Plan your system before starting your work. Take into consideration factors that affect your safety before, during, and after a fall. The following list gives some important points to consider:

- A. ANCHORAGE:** Select an anchorage capable of supporting the loads specified in Section 2.6.
- B. SHARP EDGES:** Avoid working where system components may be in contact with or abrade against sharp edges. If working around sharp edges is unavoidable, provide protection

by using a heavy pad over the exposed sharp edge.

- C. AFTER A FALL:** Components subjected to the forces of arresting a fall must be removed from service and destroyed.
- D. RESCUE:** The employer must have a rescue plan in place prior to the use of this equipment. The rescue plan must provide for a quick safe rescue.

3.3 INSTALLATION REQUIREMENTS: To ensure safe effective installation, the Saflok® Toggle Anchor should only be anchored in Precast Hollow Core Concrete, Precast Concrete, or a Steel Flange. See Figure 6 for minimum material requirements:

IMPORTANT: The Toggle Anchor should not be used in hollow block, grout, stone, wood, or other substrates. Do not use in wet or uncured concrete. The Toggle Anchor should never be pulled at an angle greater than 90 degrees.

Figure 6 - Toggle Anchor Installation

Precast Hollow Core Concrete

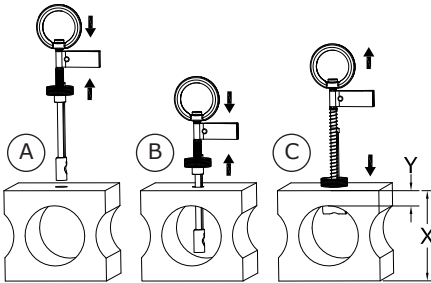

Material & Location Requirements:

Compressive Strength:	5,000 psi (34.5 MPa)
Minimum Slab Thickness (X):	6 inches (15.24 cm)
Wall Thickness (Y):	1.5 to 4.0 inches (3.81 to 10.16 cm)
Anchor Hole Minimum Edge/Corner Spacing:	6 inches (15.24 cm)

Precast Concrete

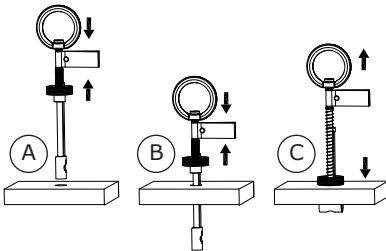

Material & Location Requirements:

Compressive Strength:	5,000 psi (34.5 MPa)
Thickness:	1.5 to 4.0 inches (3.81 to 10.16 cm)
Anchor Hole Minimum Edge/Corner Spacing:	6 inches (15.24 cm)

Steel Flange

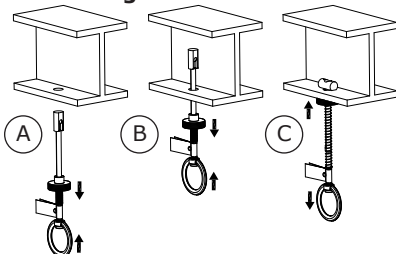

Material & Location Requirements:

Thickness:	0.25 to 4.0 inches (0.64 to 10.16 cm)
Anchor Hole Minimum Edge/Corner Spacing:	1 inch (2.54 cm)

3.4 INSTALLATION: To ensure effective installation of the Saflok® Toggle Anchor, always observe the requirements defined in Section 3.3 and Figure 6. Perform the following steps to install the Toggle Anchor. Refer to Figure 1 for component identification:

IMPORTANT: *If the Toggle Anchor will be secured in an existing hole, always inspect the hole for deformation, correct material thickness, and correct hole diameter prior to installation.*

Step 1. Mark the mounting hole location for the anchor. Observe the material and location requirements defined in Figure 1.

IMPORTANT: *For Precast Hollow Core Concrete, the mounting hole should be centered in the core hollow. See Figure 6.*

Step 2. Drill a 3/4" (19.05 mm) diameter hole through the mounting material at the location marked in Step 1.

NOTE: *A Rotary Hammer Drill and industrial grade Rotary Hammer Drill Bit are recommended for drilling Precast Concrete.*

WARNING: *Before drilling holes, inspect the hole location to prevent drilling into power transmission cables or other live utilities.*

Step 3. Install the Toggle Anchor in the mounting hole as follows:

- A. With your thumb inserted through the Swivel Ring (1A) and two forefingers under the Hole Plug (1F), squeeze the Spring (1H) until the Hole Plug is fully retracted.
- B. Insert the Toggle Anchor through the mounting hole and release the Hole Plug. The Hole Plug should seat in the inside wall of the mounting hole (Figure 7).
- C. Pull the Swivel Ring to ensure the Toggle (1G) is activated and the Toggle Anchor is secured in the mounting hole.

WARNING: *Always inspect the Activator Cable and Red Warning Tube after installation (see Figure 8). If the top of the Activator Cable (8A) is positioned adjacent to the Red Warning Tube (8B), the Toggle has not flipped into the secure position. If the Toggle is not secured; repeat Steps 3A thru 3C, but push down on the top of the Activator Cable after releasing the Hole Plug to help the toggle flip into the secure position*

Figure 7 - Hole Plug Seating

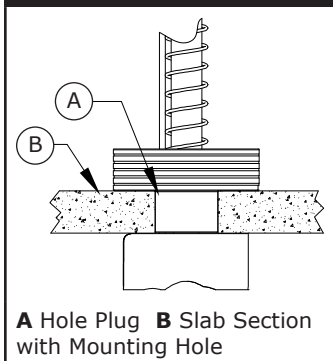
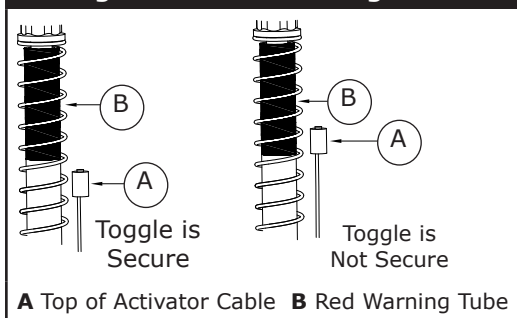

Figure 8 - Red Warning Tube



- 3.5 REMOVAL:** To release the Toggle Anchor, push the Swivel Ring (1A) toward the Release Plug (1F) to compress the Spring (1H) and then pull the Hole Plug out of the mounting hole.
- 3.6 REUSE:** The Toggle Anchor may be reused if it has not been subjected to a fall force.
- 3.7 DISPOSAL:** Dispose of the Toggle Anchor if it has been subjected to fall force or inspection (see Section 5) reveals an unsafe or defective condition. Before disposing of the Toggle Anchor, cut the Main Cable to eliminate the possibility of inadvertent reuse.
- 3.8 CONNECTIONS:** When using a hook to connect to the Saflok[®] Toggle Anchor, ensure roll-out cannot occur. Roll-out occurs when interference between the hook and mating connector causes the hook gate to unintentionally open and release. Self-locking snap hooks and carabiners should be used to reduce the possibility of roll-out. Do not use hooks or connectors that will not completely close over the attachment object. See subsystem manufacturer's instructions for information on connecting to the Toggle Anchor.

4.0 TRAINING

- 4.1** It is the responsibility of the user to assure they are familiar with these instructions, and are trained in the correct care and use of this equipment. Users must also be aware of the operating characteristics, application limits, and the consequences of improper use of this equipment.

IMPORTANT: Training must be conducted without exposing the trainee to a fall hazard. Training should be repeated on a periodic basis.

5.0 INSPECTION

To ensure safe, efficient operation, the Toggle Anchor should be inspected at the intervals defined in Section 5.1. See Section 5.2 for inspection procedures.

5.1 FREQUENCY:

- **Before Each Use:** Visually inspect the Toggle Anchor per steps listed in Sections 5.2 and 5.3.
- **Annually:** A formal inspection of the Toggle Anchor and its connection to the structure must be performed at least annually by a competent person other than the user. The frequency of formal inspections should be based on conditions of use or exposure. See sections 5.2 and 5.3. Record the inspection results in the inspection and maintenance log in section 9.0.

IMPORTANT: *Extreme working conditions (harsh environment, prolonged use, etc.) may require increasing the frequency of inspections.*

5.2 INSPECTION STEPS: Per the intervals defined in Section 5.1, inspect the Toggle Anchor as follows. (Refer to Figure 1 for component identification):

- Step 1.** Make sure the Toggle Anchor is straight and is operating smoothly.
- Step 2.** Make sure the Swivel Ring (1A) swivels freely and the Retaining Ring (1I) is secure.
- Step 3.** Make sure the label is attached to the Toggle Anchor and is legible (see Section 8).
- Step 4.** Make sure the Main Cable (1D) and Activator Cables (1E) are not frayed, kinked, or damaged.
- Step 5.** Make sure metal components are not damaged or excessively corroded.
- Step 6.** Make sure the Toggle(1G), Hole Plug (1F), and Activator Cable (1E) operate smoothly and no metal burrs are present. Ensure the Swivel Ring (1A) and Toggle do not exhibit any deformities.
- Step 7.** Inspect the position of the top of the Activator Cable relative to the Red Warning Tube (see Figure 8). When the Toggle Anchor is secured (Toggle open), the top of the Activator Cable (7A) should be positioned below the Red Warning Tube (7B). When the Toggle Anchor is released (Toggle closed), the top of the Activator Cable (7A) should be adjacent to the Red Warning Tube (7B).

NOTE: *Record the inspection date and results in the Inspection and Maintenance Log (see Section 9.0).*

5.3 DEFECTS: If inspection reveals a defective condition, remove the Toggle Anchor from service and dispose in the manner described in Section 3.7.

5.4 PRODUCT LIFE: The functional life of the Saflok® Toggle Anchor is determined by work conditions and maintenance. As long as the product passes inspection criteria, it may remain in service.

6.0 MAINTENANCE

6.1 CLEANING: After each use, blow off the Toggle Anchor with compressed air. Keep the anchor free of grease, oils, and dirt.

6.2 STORAGE: Store the Toggle Anchor in a clean dry environment. Avoid areas where chemical vapors may exist. Do not pile objects on top of the anchor. Thoroughly inspect the Toggle Anchor after extended storage.

7.0 SPECIFICATIONS

7.1 MATERIALS:

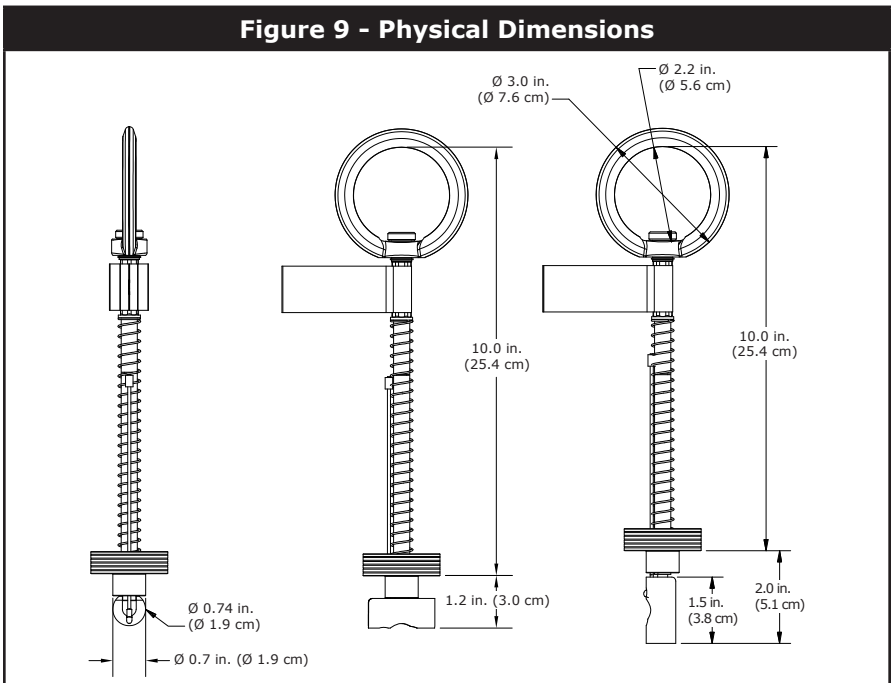

Swivel Ring:	Forged Steel
Main Cable:	Galvanized 7 x 19 Wire Rope
Hole Plug:	Aluminum
Toggle:	Stainless Steel
Activator Cable:	Galvanized Steel
Breaking Strength:	5,000 lbs. (22 kN)
Compliance:	OSHA, ANSI Z359.1

7.2 DIMENSIONS: See Figure 9 for physical dimensions of the Toggle Anchor.

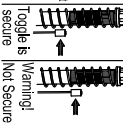

8.0 LABELING

The following label should be securely attached to the Toggle Anchor:

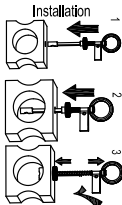
Front		Back	
<p>▲WARNING - Manufacturer's instructions supplied with this product at time of shipment are to be followed. Proper use, maintenance, and inspection, operation or repair of this equipment is required to ensure safe use. Do not use if inspection reveals an unsafe condition. Fall arrest systems must limit maximum arresting forces to 1800lbs. Do not allow fall arrest system to abrade against sharp edges. Use caution near hazardous thermal electrical or chemical sources. Make only compatible connectors. Do not exceed capacity of this or other system components. Remove from service if involved in a fall. Refer to user manual. Do not remove label. Fall protection use only.</p>  <p>Toggle Is Secured</p> <p>Not Secured</p>	<p>9504935 Rev. A www.capfality.com</p>  <p>• This product meets OSHA and ANSI Z359.1 requirements MATERIALS: Forged Steel D-Ring, 7x19 galvanized wire rope, aluminum hole plug, stainless steel toggle, and stainless steel ball and shank.</p> <p>CAPACITY: 1 person, 310 lbs max.</p>	<p>Installation: (If using an existing hole, inspect hole for deformation, correct thickness, and correct hole diameter.) Step 1: Drill a hole in concrete. The hole must be clean, free of debris, and free of any loose material. Step 2: For a steel flange, with a 3/4" hole thru the material, Steel must be between 1/4" to 2" thick. For precast concrete, use an industrial grade 2 1/2" rotary hammer drill and bit to drill hole. 1.5" to 2" thick. Step 3: Place the Toggle Anchor into the hole. The hole must be clean, free of debris, and free of any loose material. Step 4: Insert anchor into hole and release the hole plug. The hole plug should seat against the surface. Step 5: Pull the ring of the anchor and make sure the Toggle Bar is activated and the anchor is secure. Step 6: Always check that the top of the activator cable is not located in the red zone.</p>	 <p>Anchor Hole Requirements: In precast concrete, the edge of the hole must be at least 1" away from any corner. The edge of the hole must be at least 1" away from any edge or corner. Do not use in wet or un-cured concrete. Anchor should not be pulled at an angle greater than 90 degrees. Grip the 3/16" hole plug and pull the anchor from the hole.</p>

9.0 INSPECTION AND MAINTENANCE LOG

SERIAL NUMBER: _____

MODEL NUMBER: _____

DATE PURCHASED: _____ DATE FIRST USED: _____

INSPECTION DATE	INSPECTION ITEMS NOTED	CORRECTIVE ACTION	MAINTENANCE PERFORMED
Approved By: _____			
Approved By: _____			
Approved By: _____			
Approved By: _____			
Approved By: _____			
Approved By: _____			
Approved By: _____			
Approved By: _____			
Approved By: _____			
Approved By: _____			
Approved By: _____			
Approved By: _____			

WARRANTY

Equipment offered by DBI-SALA is warranted against factory defects in workmanship and materials for a period of two years from date of installation or use by the owner, provided that this period shall not exceed two years from date of shipment. Upon notice in writing, DBI-SALA will promptly repair or replace all defective items. DBI-SALA reserves the right to elect to have any defective item returned to its plant for inspection before making a repair or replacement. This warranty does not cover equipment damages resulting from abuse, damage in transit, or other damage beyond the control of DBI-SALA. This warranty applies only to the original purchaser and is the only one applicable to our products, and is in lieu of all other warranties, expressed or implied.



CSG USA

3833 Sala Way
Red Wing, MN 55066-5005
Toll Free: 800.328.6146
Phone: 651.388.8282
Fax: 651.388.5065
solutions@capitalsafety.com

CSG Canada Ltd.

260 Export Boulevard
Mississauga, Ontario L5S 1Y9
Toll Free: 800.387.7484
Phone: 905.795.9333
Fax: 905.795.8777
sales.ca@capitalsafety.com

www.capitalsafety.com



Certificate No. FM 39709