



SKATEBOARD LOCKERS



ASSEMBLY INSTRUCTIONS

Please note that the parts are located inside one locker bay inside the shipping box, so look inside carefully.

ASSEMBLY Parts Included Per Single-sided Unit of 8 lockers
 2 Pre-assembled leg footings w/4 concrete Anchor bolts/washers/nuts
 8 Bolts/nuts that connect locker unit to 2 footings (4 per footing)

ASSEMBLY Parts included Per Double-sided Unit of 16 Lockers
 2 Pre-assembled leg footings w/4 concrete Anchor bolts/washers/nuts
 4 Bolts/nuts that connect locker unit to 2 footings (2 per footing)
 2 Connector Plates with 2 bolt pins and nuts (1 per footing)

TOOLS NEEDED:

- Wrench or Socket wrench 7/16"
- Wrench or Socket wrench 1/4"
- Hammer Drill with 1/2" x 4" Masonry Bit
- 2 SAW horses when applicable or preferred

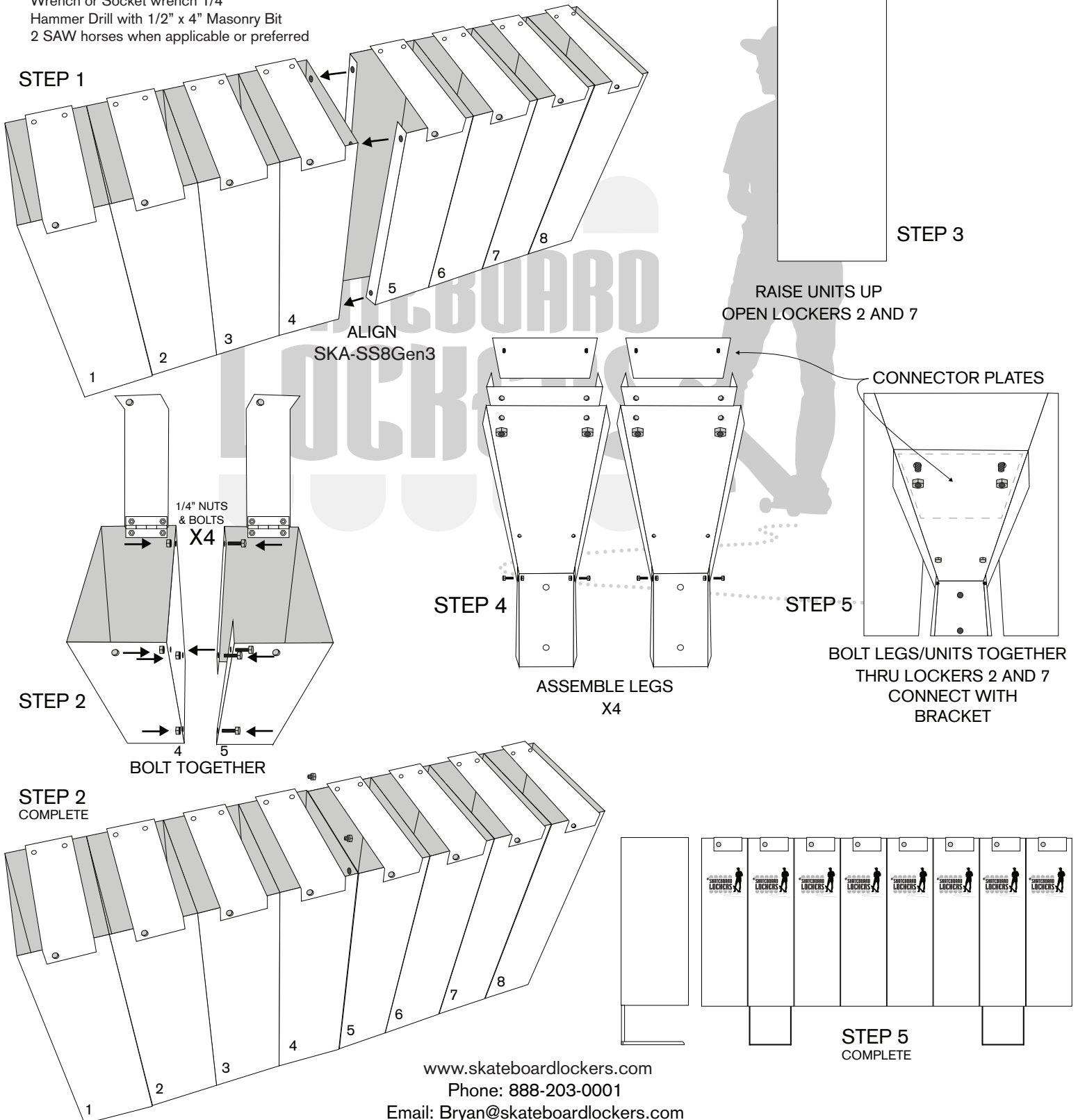

www.skateboardlockers.com

Phone: 888-203-0001

Email: Bryan@skateboardlockers.com

AVAILABLE UNITS AND CONFIGURATIONS

SKA-SS8Gen3 (Single-sided Standard 8 Skateboard/Scooter locker unit)
 SKA-SLB8Gen3 (Single-sided Longboard 8 Skateboard/Scooter locker unit)

Also available in Double-sided Configuration (24"x 46"x27")

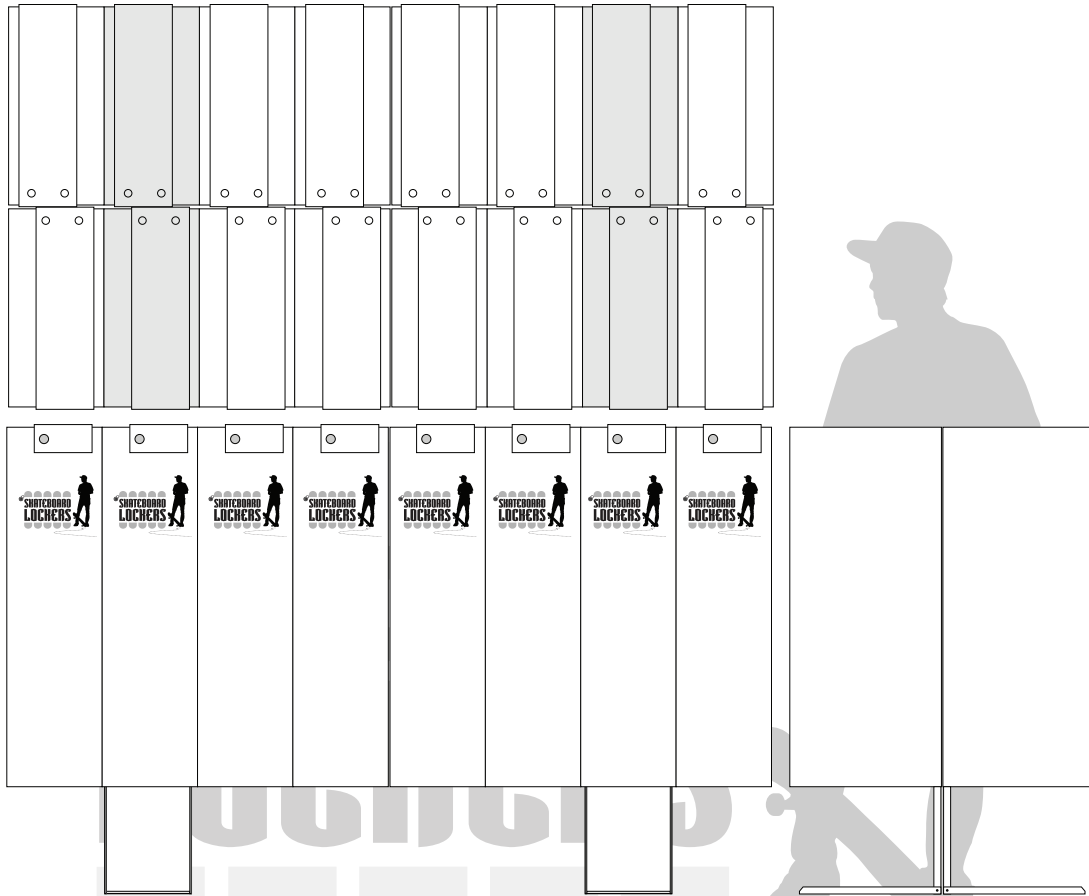

SKA-DS16Gen3 (Double-sided Standard 16 Skateboard/Scooter locker unit)

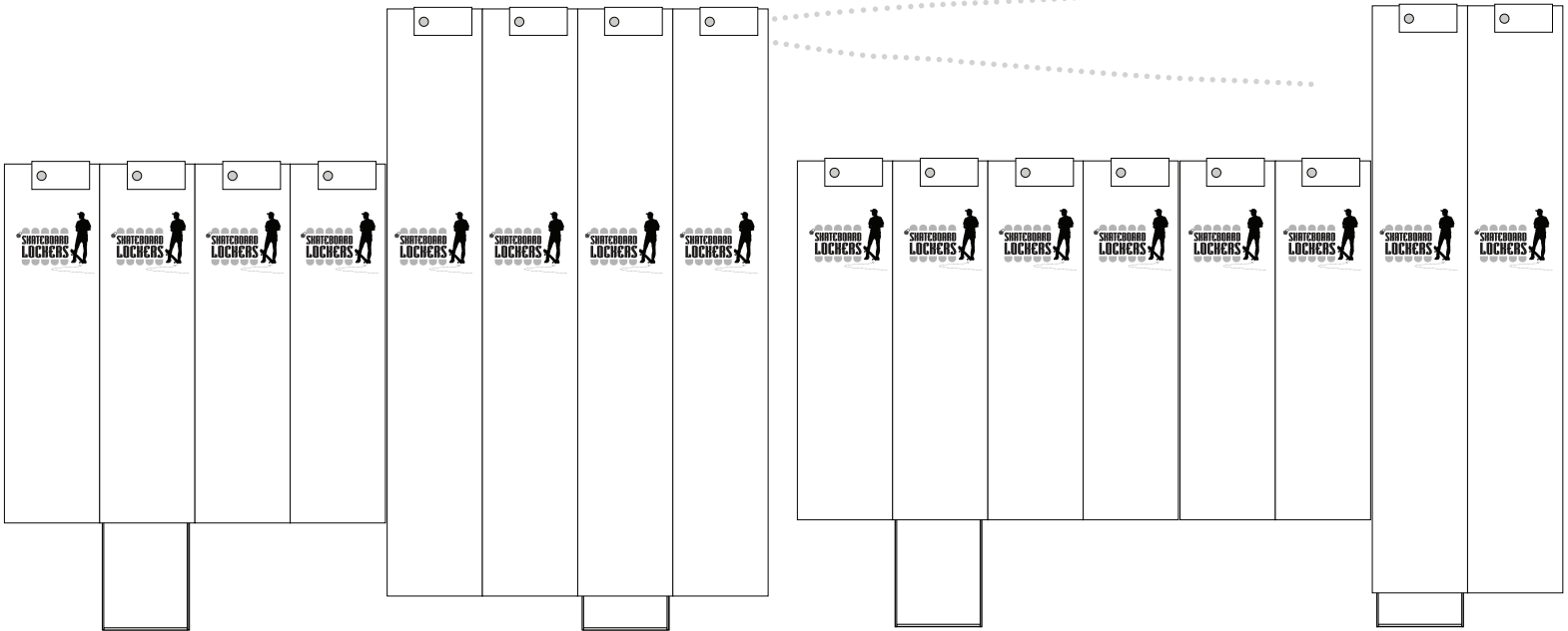

SKA-SS4LB4Gen3
 (Single-sided Combo 4 Standard &
 4 Longboard Skateboard/Scooter locker unit)

SKA-SS6LB2Gen3
 (Single-sided Combo 6 Standard &
 2 Longboard Skateboard/Scooter locker unit)

ASSEMBLY AND INSTALL

CONNECTION

CONNECT LOCKER #4 and #5 (By position)

1. The bolt and nuts are connected to Locker #4 already to hold them in place temporarily, so nuts need to be unscrewed
2. Align lockers
3. Keep bolts in place
4. Tighten nuts and bolts together
5. Move unit to final location
6. Prepare to install

INSTALL

1. Place on the concrete and the holes need to be marked
2. Move the lockers bank aside
3. Drill holes with easy access.
4. Pound the Anchor bolts into holes (Use a sledge-hammer or slide hammer)
5. Leave about 1/4"-1/2" of thread showing above the nut.
6. Place lockers with Leg/feet back over the holes
7. Secure into place by bolting down anchors

INSIDE LOCKERS (2 AND 7)

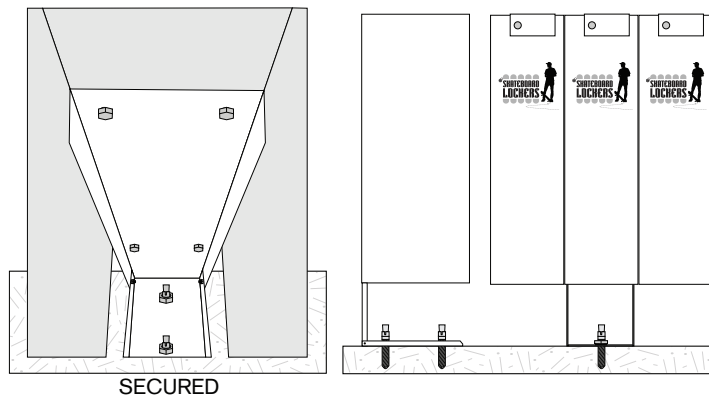
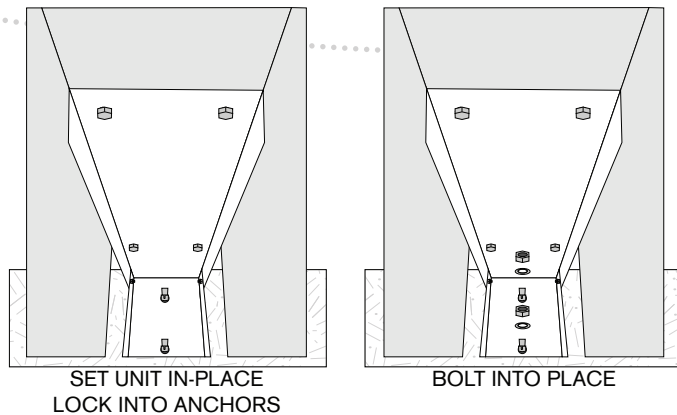
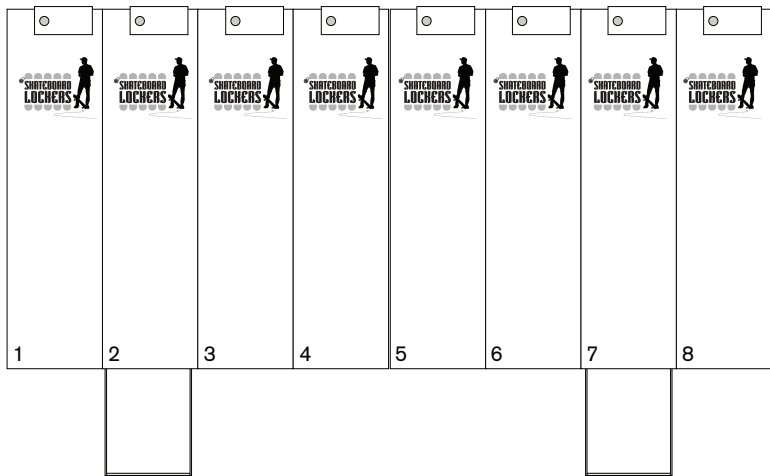
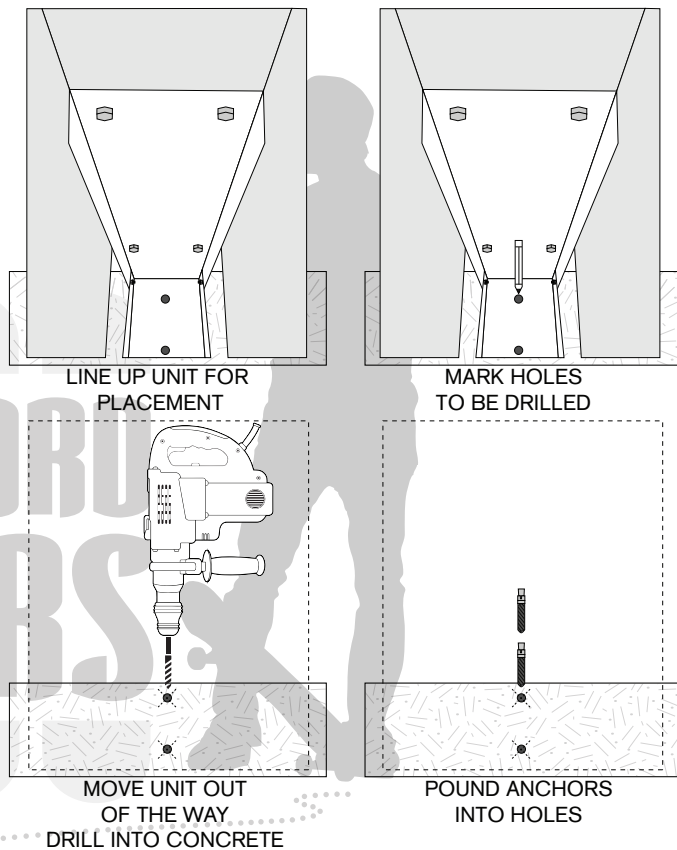
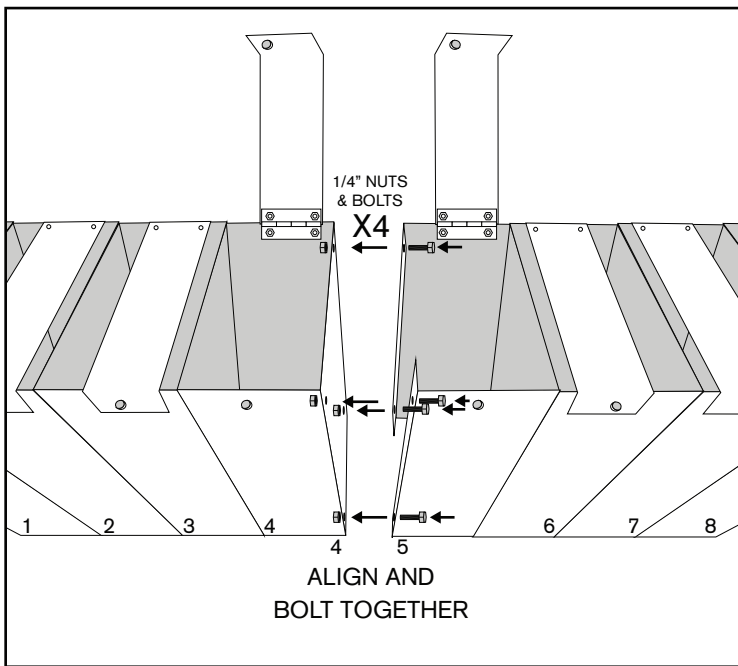

For more detailed instructions go to:
www.skateboardlockers.com and
 Select OUR PRODUCTS tab >>>
 Download the PDF instructions for more details.
 Or contact us at 888.203.0001