

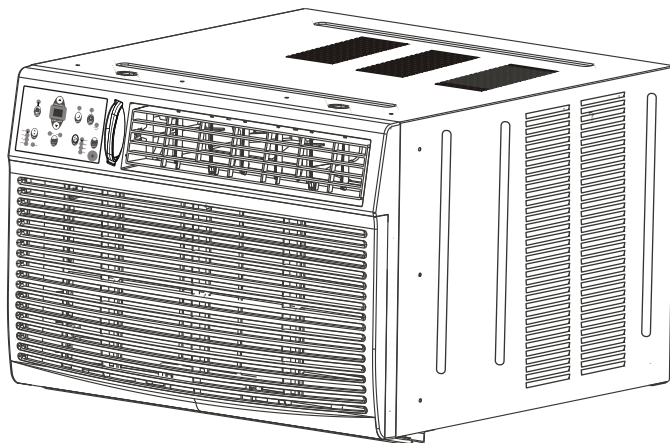

USER'S MANUAL

WINDOW/WALL-TYPE ROOM AIR CONDITIONER



MULTI-STEP SPEED ELECTRONIC CONTROL

MODEL:246538+292460

TABLE OF CONTENTS

Important Safety Instructions	1-3	Normal Sounds	11
Installation Instructions	4-10	Air Conditioner Features.....	11-13
		Care and Cleaning	13-14
		Troubleshooting Tip.....	14-15

Before using your air conditioner, please read this manual carefully and keep it for future reference.



Product Registration Card

It's simple! Complete and mail your Product Registration Card today!

Name

Address

City State Zip

Phone (Optional) / -

E-mail Address (Optional)

Where Purchased

Model Number	Serial Number	Month	Day	Year	Date of Purchase

REV 11/04

Please return your Product Registration Card today!

MIDEA AMERICA CORPORATION
PRODUCT REGISTRATION CENTER
11800 NW 100 ROAD STE 4
MEDLEY FL 33178-1037



PLACE
STAMP
HERE

Postage
Required.
Post Office will
not deliver
without proper
postage.

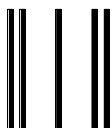



Product Warranty Card

Air conditioner warranty

Your product is protected by this warranty:
Your appliance is warranted by Midea. Any obligations for services and parts under this warranty must be performed by Midea Consumer Services or an authorized Midea servicer
To contact a Customer Service Representative, Call Midea TOLL FREE





1-866-646-4332®

IMPORTANT SAFETY INSTRUCTIONS















READ THIS MANUAL

Inside you will find many helpful hints on how to use and maintain your air conditioner properly. Just a little preventive care on your part can save you a great deal of time and money over the life of your air conditioner. You'll find many answers to common problems in the chart of troubleshooting tips. If you review our chart of Troubleshooting Tips first, you may not need to call for service at all.

To prevent injury to the user or other people and property damage, the following instructions must be followed. Incorrect operation due to ignoring of instructions may cause harm or damage. The seriousness is classified by the following indications.

 WARNING	This symbol indicates the possibility of death or serious injury.		
 CAUTION	This symbol indicates the possibility of injury or damage to property.		
	Never do this.		Always do this.

WARNING

 Plug in power plug properly.	 Do not operate or stop the unit by inserting or pulling out the power plug.	 Do not damage or use an unspecified power cord.
<ul style="list-style-type: none"> • Otherwise, it may cause electric shock or fire due to excess heat generation. 	<ul style="list-style-type: none"> • It may cause electric shock or fire due to heat generation. 	<ul style="list-style-type: none"> • It may cause electric shock or fire. • If the power cord is damaged, it must be replaced by the manufacturer or an authorised service centre or a similarly qualified person in order to avoid a hazard.
 Always install circuit breaker and a dedicated power circuit.	 Do not operate with wet hands or in damp environment.	 Do not direct airflow at room occupants only.
<ul style="list-style-type: none"> • Incorrect installation may cause fire and electric shock. 	<ul style="list-style-type: none"> • It may cause electric shock. 	<ul style="list-style-type: none"> • This could damage your health.
 Always ensure effective grounding.	 Do not allow water to run into electric parts.	 Do not modify power cord length or share the outlet with other appliances.
<ul style="list-style-type: none"> • Incorrect grounding may cause electric shock. 	<ul style="list-style-type: none"> • It may cause failure of machine or electric shock. 	<ul style="list-style-type: none"> • It may cause electric shock or fire due to heat generation.
 Unplug the unit if strange sounds, smell, or smoke comes from it.	 Do not use the socket if it is loose or damaged.	 Do not open the unit during operation.
<ul style="list-style-type: none"> • It may cause fire and electric shock. 	<ul style="list-style-type: none"> • It may cause fire and electric shock. 	<ul style="list-style-type: none"> • It may cause electric shock.
 Keep firearms away.	 Do not use the power cord close to heating appliances.	 Do not use the power cord near flammable gas or combustibles, such as gasoline, benzene, thinner, etc.
<ul style="list-style-type: none"> • It may cause fire. 	<ul style="list-style-type: none"> • It may cause fire and electric shock. 	<ul style="list-style-type: none"> • It may cause an explosion or fire.
 Ventilate room before operating air conditioner if there is a gas leakage from another appliance.	 Do not disassemble or modify unit.	
<ul style="list-style-type: none"> • It may cause explosion, fire and, burns. 	<ul style="list-style-type: none"> • It may cause failure and electric shock. 	

IMPORTANT SAFETY INSTRUCTIONS

CAUTION

⊘ When the air filter is to be removed, do not touch the metal parts of the unit.

- It may cause an injury.

⊘ Do not use strong detergent such as wax or thinner but use a soft cloth.

- Appearance may be deteriorated due to change of product color or scratching of its surface.

⊘ Stop operation and close the window in storm or hurricane.

- Operation with windows opened may cause wetting of indoor and soaking of household furniture.

⊘ Always insert the filters securely. Clean filter once every two weeks.

- Operation without filters may cause failure.

⊘ Do not place obstacles around air-inlets or inside of air-outlet.

- It may cause failure of appliance or accident.

⊘ Use caution when unpacking and installing. Sharp edges could cause injury.

⊘ Do not put a pet or house plant where it will be exposed to direct air flow.

- This could injure the pet or plant.

⊘ Do not clean the air conditioner with water.

- Water may enter the unit and degrade the insulation. It may cause an electric shock.

⊘ When the unit is to be cleaned, switch off, and turn off the circuit breaker.

- Do not clean unit when power is on as it may cause fire and electric shock, it may cause an injury.

⊘ Hold the plug by the head of the power plug when taking it out.

- It may cause electric shock and damage.

⊘ Do not place heavy object on the power cord and ensure that the cord is not compressed.

- There is danger of fire or electric shock.

⊘ If water enters the unit, turn the unit off at the power outlet and switch off the circuit breaker. Isolate supply by taking the power-plug out and contact a qualified service technician.

⊘ Ventilate the room well when used together with a stove, etc.

- An oxygen shortage may occur.

⊘ Do not use for special purposes.

- Do not use this air conditioner to preserve precision devices, food, pets, plants, and art objects. It may cause deterioration of quality, etc.

⊘ Ensure that the installation bracket of the outdoor appliance is not damaged due to prolonged exposure.

- If bracket is damaged, there is concern of damage due to falling of unit.

⊘ Turn off the main power switch when not using the unit for a long time.

- It may cause failure of product or fire.

⊘ Do not drink water drained from air conditioner.

- It contains contaminants and could make you sick.

CAUTION

- This appliance is not intended for use by persons (including children) with reduced physical, sensory or mental capabilities or lack of experience and knowledge, unless they have been given supervision or instruction concerning use of the appliance by a person responsible for their safety.
- Children should be supervised to ensure that they do not play with the appliance.
- If the supply cord is damaged, it must be replaced by the manufacturer, its service agent or similarly qualified persons in order to avoid a hazard.

- The appliance shall be installed in accordance with national wiring regulations.
- Do not operate your air conditioner in a wet room such as a bathroom or laundry room.
- The appliance with electric heater shall have at least 1 meter space to the combustible materials.
- Contact the authorised service technician for repair or maintenance of this unit.
- Contact the authorised installer for installation of this unit.

IMPORTANT SAFETY INSTRUCTIONS

NOTE:

The power supply cord with this air conditioner contains a current detection device designed to reduce the risk of fire. Please refer to the section Operation of Current Device for details. In the event that the power supply cord is damaged, it cannot be repaired-it must be replaced with a cord from the Product Manufacturer.

WARNING

Avoid fire hazard or electric shock. Do not use an extension cord or an adaptor plug. Do not remove any prong from the power cord.

Grounding type wall receptacle

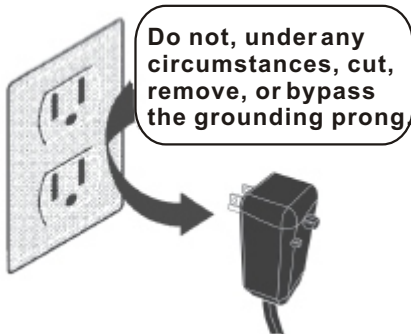

Power supply cord with 3-prong grounding plug and current detection device

WARNING

For Your Safety

Do not store or use gasoline or other flammable vapors and liquids in the vicinity of this or any other appliance.

WARNING

Prevent Accidents

To reduce the risk of fire, electrical shock, or injury to persons when using your air conditioner, follow basic precautions, including the following:

- Be sure the electrical service is adequate for the model you have chosen. This information can be found on the serial plate, which is located on the side of the cabinet and behind the grille.
- If the air conditioner is to be installed in a window, you will probably want to clean both sides of the glass first. If the window is a triple-track type with a screen panel included, remove the screen completely before installation.
- Be sure the air conditioner has been securely and correctly installed according to the installation instructions in this manual. Save this manual for possible future use in removing or installing this unit.
- When handling the air conditioner, be careful to avoid cuts from sharp metal fins on front and rear coils.

WARNING

Electrical Information

The complete electrical rating of your new room air conditioner is stated on the serial plate. Refer to the rating when checking the electrical requirements.

- Be sure the air conditioner is properly grounded. To minimize shock and fire hazards, proper grounding is important. The power cord is equipped with a three-prong grounding plug for protection against shock hazards.
- Your air conditioner must be used in a properly grounded wall receptacle. If the wall receptacle you intend to use is not adequately grounded or protected by a time delay fuse or circuit breaker, have a qualified electrician install the proper receptacle. Ensure the receptacle is accessible after the unit installation.
- Do not run air conditioner without side protective cover in place. This could result in mechanical damage within the air conditioner.
- **Do not use an extension cord or an adaptor plug.**

Operation of Current Device

(Applicable to the unit adopts current detection device only)

The power supply cord contains a current device that senses damage to the power cord. To test your power supply cord do the following:

1. Plug in the Air Conditioner.
2. The power supply cord will have TWO buttons on the plug head. Press the TEST button, you will notice a click as the RESET button pops out.
3. Press the RESET button, again you will notice a click as the button engages.
4. The power supply cord is now supplying electricity to the unit. (On some products this is also indicated by a light on the plug head.)

NOTE:

- Do not use this device to turn the unit on or off.
- Always make sure the RESET button is pushed in for correct operation.
- The power supply must be replaced if it fails reset when either the TEST button is pushed, or it cannot be reset. A new one can be obtained from the product manufacturer.
- If power supply cord is damaged, it cannot be repaired. It MUST be replaced by one obtained from the product manufacturer.

NOTE: This air conditioner is designed to be operated under condition as follows:

Cooling operation	Outdoor temp:	64-109°F/18-43°C (64-125°F/18-52°C for special tropical models)
	Indoor temp:	62-90°F/17-32°C
Heating operation	Outdoor temp:	23-76°F/-5-24°C
	Indoor temp:	32-80°F/0-27°C

Note: Performance may be reduced outside of these operating temperatures.

INSTALLATION INSTRUCTIONS



BEFORE YOU BEGIN

Read these instructions completely and carefully.

IMPORTANT- Save these instructions for local inspector's use.

IMPORTANT- Observe all governing codes and ordinances.

Note to Installer- Be sure to leave these instructions with the Consumer.

Note to Consumer- Keep these instructions for future reference.

Skill level- Installation of this appliance requires basic mechanical skills.

Completion time- Approximately 1 hour. We recommend that two people install this product.

Proper installation is the responsibility of the installer.

Product failure due to improper installation is not covered under the Warranty.

You **MUST** use all supplied parts and use proper installation procedures as described in these instructions when installing this air conditioner.



CAUTION

Do not, under any circumstances, cut or remove the third (ground) prong from the power cord.

Do not change the plug on the power cord of the air conditioner.

Aluminum house wiring may present special problems- consult a qualified electrician.

When handling unit, be careful to avoid cuts from sharp metal edges and aluminum fins on front and rear coils.



NOTE:

Save Carton and these Installation Instructions for future reference. The carton is the best way to store unit during winter, or when not in use.

Preliminary Instructions

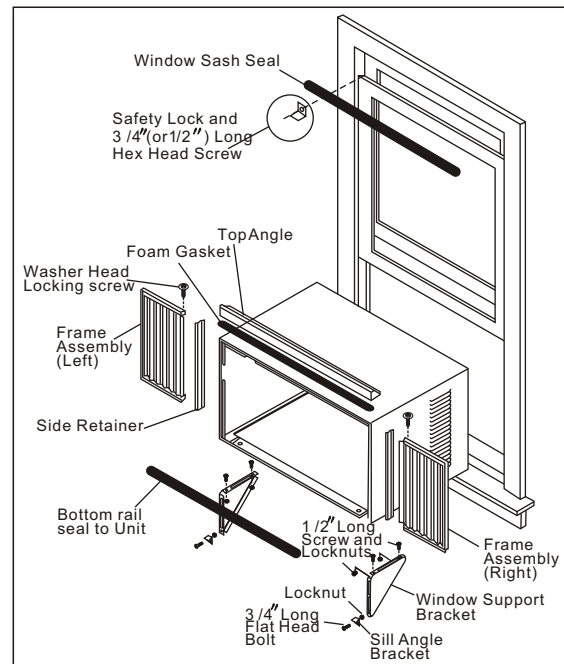

Do the following before starting to install unit. See illustrations below.

Check dimensions of your unit to determine model type:

Unit Height:	18 5/8"	17 5/8"
Unit Width:	26 1/2"	23 5/8"
Min. Window Opening:	19 1/2"	18 1/2"
Min. Window Width:	31"	26 1/2"
Max. Window Width:	42"	40 1/2"

Fig.D

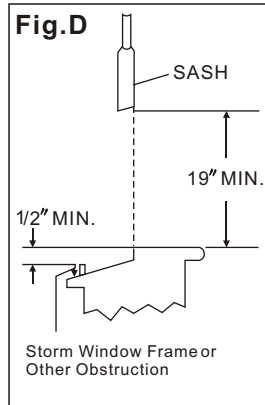
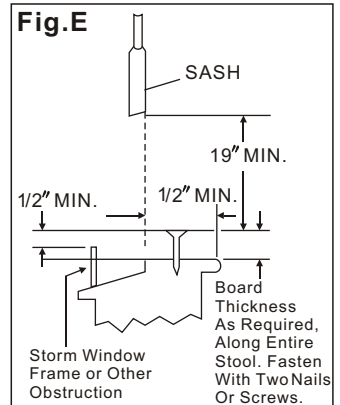

Fig.E











- 1. Check window opening size--** the mounting parts furnished with this air conditioner are made to install in a wooden sill double-hung window. The standard parts are for window dimensions listed above. Open sash to a minimum of 19 inches (483mm). See Fig.D.
- 2. Check condition of window--** all wood parts of window must be in good shape and able to firmly hold the needed screws. If not, make repairs before installing unit.

INSTALLATION INSTRUCTIONS

Preliminary Instructions

3. **Check your storm windows**-- if your storm window frame does not allow the clearance required, correct by adding a piece of wood as shown in Fig. E, or by removing storm window while room air conditioner is being installed.
4. **Check for anything that could block airflow**-- check area outside of window for things such as shrubs, trees, or awnings. Inside, be sure furniture, drapes, or blinds will not stop proper airflow.
5. **Check the available electrical service**- Power supply must be the same as that shown on the unit serial nameplate. Power cord is 48 inches long. Be sure you have an outlet near.
6. **Carefully unpack air conditioner**- Remove all packing material. Protect floor or carpet from damage. Two people should be used to move and install unit.

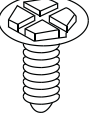
Hardware(Packed with the unit)

	7/16 inch Locking screw and Flat washer for window panels	2 ea.
	3 / 4 (or 1/2)inch Long Hex-head Screw	4
	Safety Lock	1
	1 / 2 inch Long screw and Locknut	4ea.
	3 / 4 inch Long Flat Head Bolt and Locknut	2ea.
	Sill Angle Bracket	2
	Long hex-head locking screw for top angle, side retainer 5 / 16 inch Long	10
	Foam insert	2
	Window sash seal foam	1

Tools Required

A large flat blade screwdriver; Tape measure
Adjustable wrench or pliers; Pencil; Level
Socket wrenches; Phillips Screwdriver

A.Window Mounting

1 Remove Chassis

1. Pull down front grille and remove filter.
(See Fig.1).
2. Lift front grille upwards and place to one side.
3. Locate the four front screws and remove. These screws will be needed to re-install the front panel (see Fig.2).

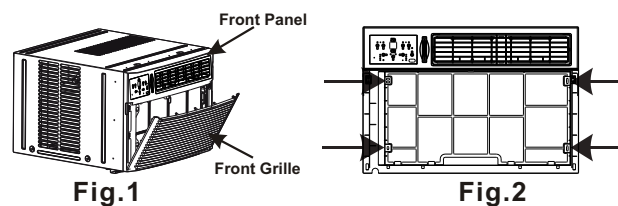

Fig.1

Fig.2

4. Push metal cabinet side to release plastic tabs on each side of front panel (see Fig.3).
5. Gently lift front panel off unit(see Fig.3A).
6. Disconnect the connector plug of the display panel from the unit and place front panel to one side(see Fig.4).

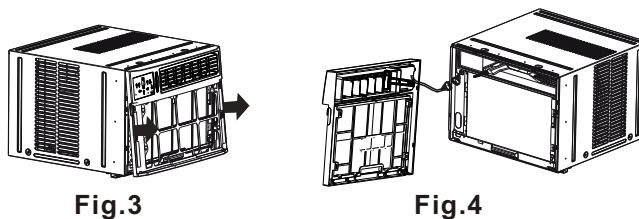

Fig.3

Fig.4

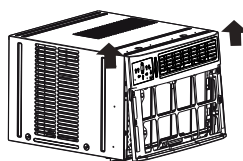

Fig.3A

7. Remove shipping screws from top of unit and also on the side by the base if installed (see Fig.5).
8. Hold the cabinet while pulling on the base pan handle, and carefully remove the unit.
9. Add two foam inserts to holes in top of cabinet where shipping screws were removed from (see Fig.6).

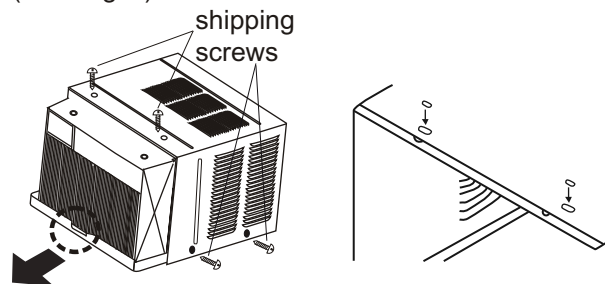

Fig.5

Fig.6

INSTALLATION INSTRUCTIONS

10. Your unit may come with internal packaging. This packaging must be removed prior to installing the air conditioner back into the cabinet. (see Fig.7).

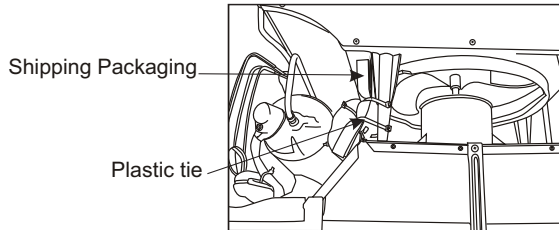

Fig.7

2 Install Top Angle and Side Bracket

1. Attach foam gasket to top angle above holes as shown in Fig.6.
2. Install top angle and side retainers to cabinet as shown in Fig.8 (10 screws).

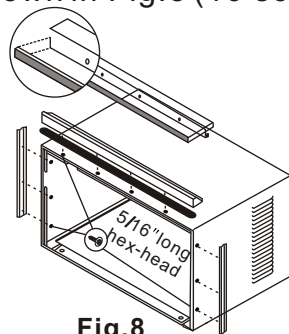

Fig.8

3 Assemble Window Filler Panels

1. Place cabinet on floor, a bench, or a table.
2. Slide "I" section of window filler panel into side retainer on the side of the cabinet (see Fig.9 & Fig.10). Do both sides.

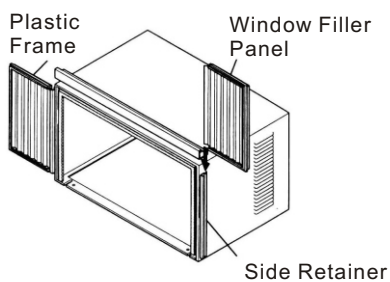

Fig.9

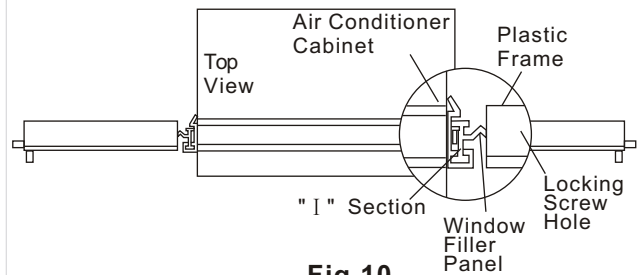

Fig.10

3. Insert top and bottom legs of window filler panel frame into channel in the top angle and bottom rail. Do both sides.
4. Insert washer head locking 7/16" screws (2) into holes in top leg of filler panel frame (see step 6). Do not totally tighten. Allow leg to slide freely. Screws will be tightened after section 6.

4 Place Cabinet in

1. Open window and mark center of window stool as shown (Fig.11).
2. Place cabinet in window with bottom stool angle firmly seated over window stool as shown. Bring window down temporarily behind top angle to hold cabinet in place (Fig.12).

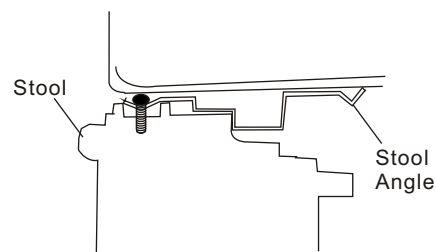
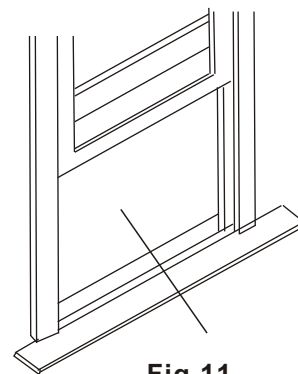

Fig.12

3. Shift cabinet left or right as needed to line up center of cabinet on center line marked on stool.
4. Fasten cabinet to window stool with 2 screws into holes (You may wish to pre-drill pilot holes).
5. Add bottom rail seal over screws to window stool.

INSTALLATION INSTRUCTIONS

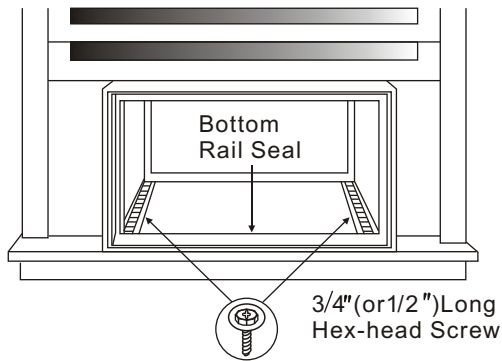

Fig. 13

5 Install Support Bracket

1. Hold each support bracket flush against outside of sill, and tight to bottom of cabinet as shown in Fig. 15A. Mark brackets at top level of sill, and remove.
2. Assemble sill angle bracket to support brackets at the marked position (Fig. 15B). Hand tighten, but allow for any changes later.

NOTE: Check that air conditioner is tilted back about $1\frac{1}{4}''$ to $1\frac{5}{8}''$ (tilted about 3° to 4° downward to the outside). After proper installation, condensate should not drain from the overflow drain hole during normal use, correct the slope otherwise (Fig. 14).

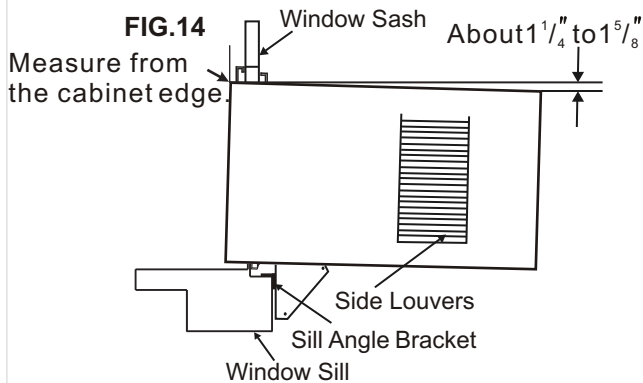

FIG. 14

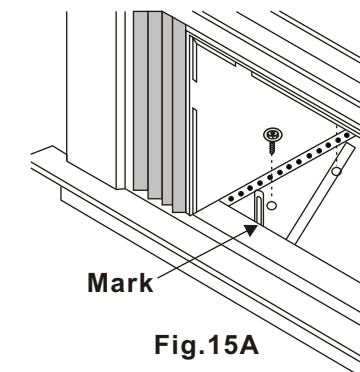

Fig. 15A

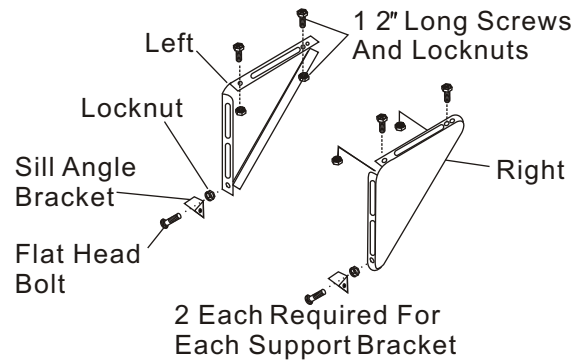

Fig. 15B

3. Install support brackets (with sill angle brackets attached) to correct hole in bottom of cabinet as shown in Fig. 16.
4. Tighten all 6 bolts securely.

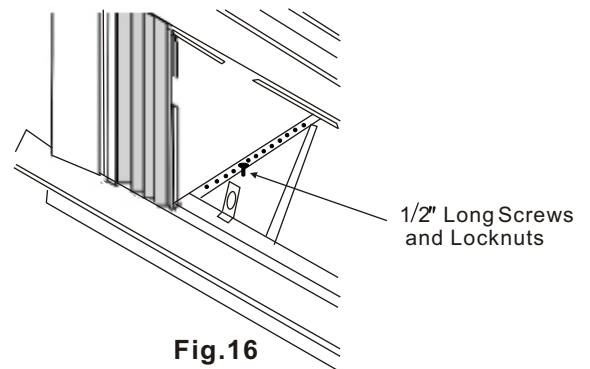

Fig. 16

6 Extend Window Filler Panels

1. Carefully raise window to expose filler panel locking screws. Loosen screws so filler panels slide easily.
2. Extend panels to fill window opening completely. Tighten locking screws on top (Fig. 17).
3. Close window behind top angle.

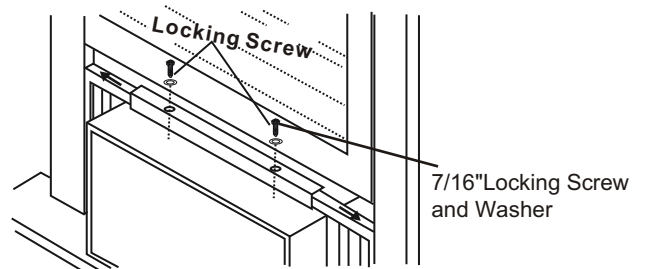

Fig. 17

INSTALLATION INSTRUCTIONS

7 Install Window Sash Seal and Safety Lock

1. Trim sash seal to fit window width. Insert into space between upper and lower sashes (Fig. 18).

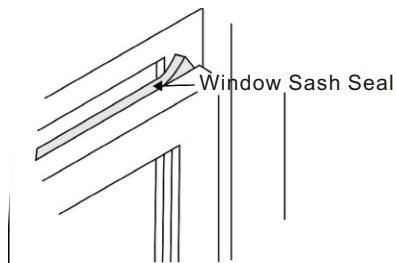

Fig. 18

2. Attach right angle safety lock (Fig. 19).

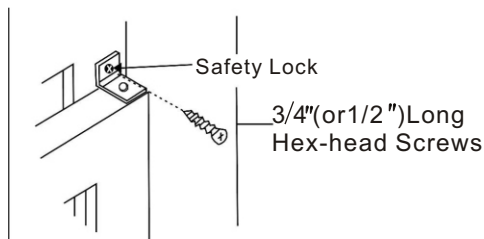

Fig. 19

8 Install Chassis into Cabinet and Install Front to Unit

1. Lift air conditioner and carefully slide into cabinet leaving 6 inches protruding.
2. DO NOT push on controls or finned coils.
3. Be sure chassis is firmly seated towards rear of cabinet.
4. Installation of front is the reverse of removal outlined in Section 1.

B. Thru-The-Wall Installation

NOTE: Consult local building codes prior to installation, or a qualified carpenter.

1 Select Wall Location

The air conditioner has a slide-out chassis, so that it can be installed through an outside wall as specified below:

Max. Wall thickness: 12" or 10"

IMPORTANT: Side louvers must never be blocked.

NOTE: All parts needed for Thru-The-Wall Installation are provided, except a wood frame, shims, and 10 wood screws (#10-1" long minimum).

Select a wall surface that:

1. does not support major structural loads such as the frame construction at ends of windows, and under truss-bearing points, etc.

2. does not have plumbing or wiring inside.
3. is near existing electrical outlets, or where another outlet can be installed.
4. faces, and is not blocked to the area to be cooled.
5. allows unblocked airflow from rear sides and end (outside) of installed air conditioner.

2 Prepare Wall

1. Prepare wall in frame construction (including brick and stucco veneer). Working from inside the room, find wall stud nearest the center of area where air conditioner will be installed (by sounding wall, or by magnetically finding nails).
2. Cut or knock out a hole on each side of center stud.
3. Measure between inside edges of every other stud as shown in Fig. 1.

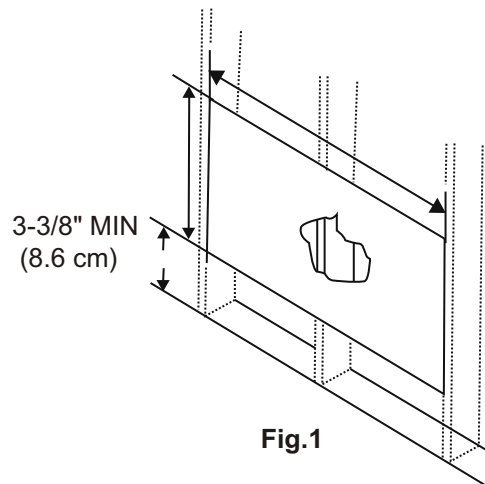

Fig. 1

Carefully measure and cut an opening with the following dimensions depending on your model. See Fig. 1 and Fig. 2.

WIDTH "X" = inside model width plus twice the thickness of framing material used.

HEIGHT "Y" = inside model height plus twice the thickness of framing material used.

Inside Frame Height: 18-7/8" (47.9cm) or 18" (45.7cm)

Inside Frame Width: 26-3/4" (67.9cm) or 23-7/8" (60.6cm)

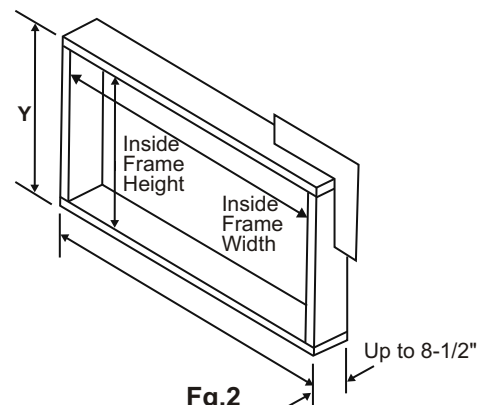

Fig. 2

INSTALLATION INSTRUCTIONS

- Build a wooden frame with the INSIDE dimensions of your model listed above. (Measure twice remember). Frame depth should be the same as wall thickness. Fill in the space from the opening to the studs with wood spacers, as shown.
- Nail frame to spacers to studs with front flush with drywall.

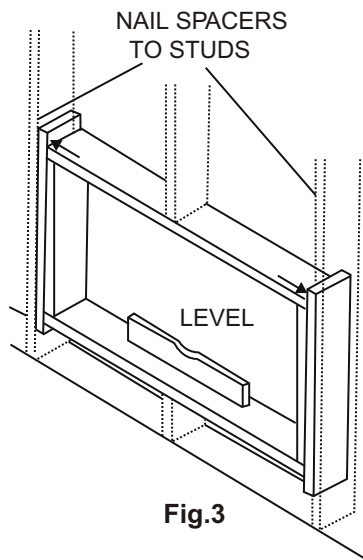

Fig.3

NOTE: If wall thickness is 8-1/2" or more, add aluminum flashing over bottom of frame opening to assure no water can enter area between inner and outer wall.

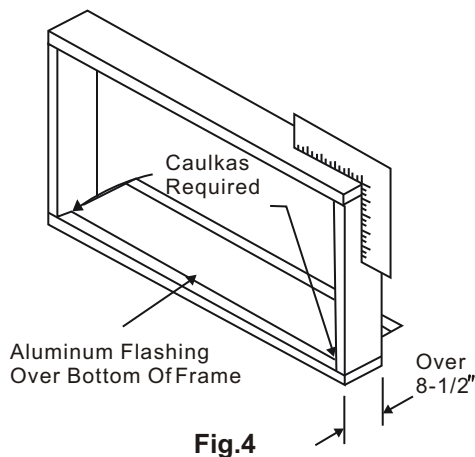

Fig.4

3 Prepare and Install Cabinet

- Slide chassis from cabinet. Refer back to Step one of Window Mounting.
- Place cabinet into opening with bottom rail resting firmly on bottom board of wooden frame.
- Position cabinet to achieve proper slope for water removal. (See Fig.5 below.)
- Secure bottom rail to wood frame with two large wood screws 1" (2.5cm) long using the two holes in the bottom of the channel resting on frame. (See Fig.6).

NOTE: Check that air conditioner is tilted back about 1 1/4" to 1 5/8" (tilted about 3° to 4° downward to the outside). After proper installation, condensate should not drain from the overflow drain hole during normal use, correct the slope otherwise (Fig.14).

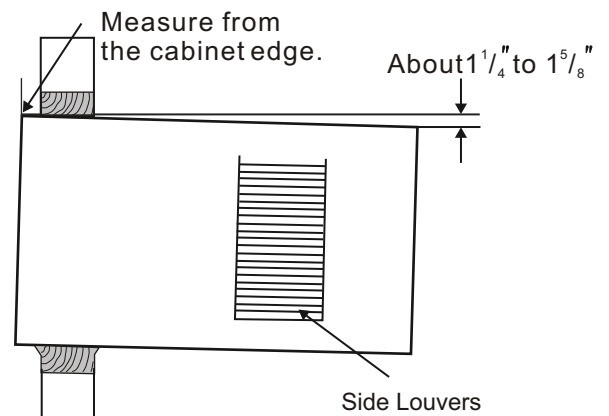

Fig.5

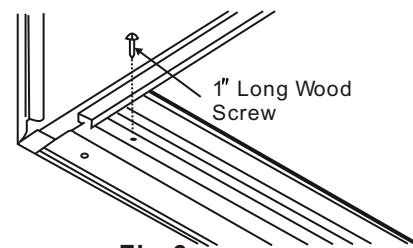

Fig.6

Refer to Step 5 of Window Mounting for assembly of support brackets. A wooden strip nailed to the outside wall should be used in conjunction with sill support angle brackets.

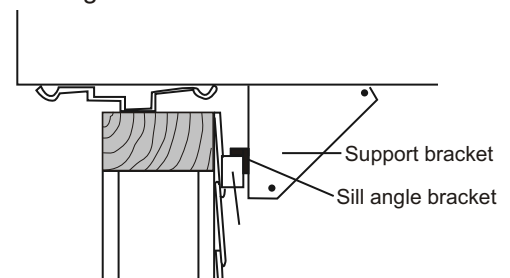

Fig.7

INSTALLATION INSTRUCTIONS

5. Screw or nail cabinet wooden frame using shims if frame is oversized, to eliminate distortion. See Fig.8. Remember to maintain proper slop as described in Step 3.

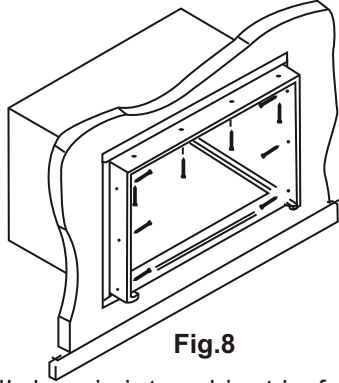

Fig.8

6. Install chassis into cabinet by following all steps in Step 8 of Window Mounting.

OPTIONAL: Caulking and installation of trim on interior wall may be done. You can buy wood from your local lumber or hardware supply. On the outside, caulk openings around top and sides of cabinet, and all sides of wood sleeve to the opening.

NOTE: See Step 5, Item 3 of Window Mounting Instructions for bottom rail seal location.

C.Masonry Construction

1. Cut or build a wall opening in the masonry wall similar to the frame construction (refer to Step 2 of Thru-the-wall Installation for a wall thickness greater than 8-1/2').
2. Secure cabinet in place using masonry nails, or the right masonry anchor screws. (Another way to do this is to build an in-between frame of 2x4 s as shown in the Step 2 Prepare Wall illustrations-but make it double framed on either side, and install between masonry wall opening and cabinet. Frame must be securely anchored to masonry wall opening). This way gives very good louver clearance on either side of cabinet.
3. Install a lintel to support masonry wall above cabinet. Existing holes in cabinet can be used and/ or additional holes can be drilled to fasten cabinet at various positions. Be sure that side louver clearance is in accordance with Step 1 above.
4. Install exterior cabinet support brackets as shown in Step 2 of Thru-the-wall installation. Caulk or flash if needed, to provide a weather-tight seal around top and sides of cabinet.
5. To complete installation, apply wood trim molding around room side projection of cabinet.

NORMAL SOUNDS

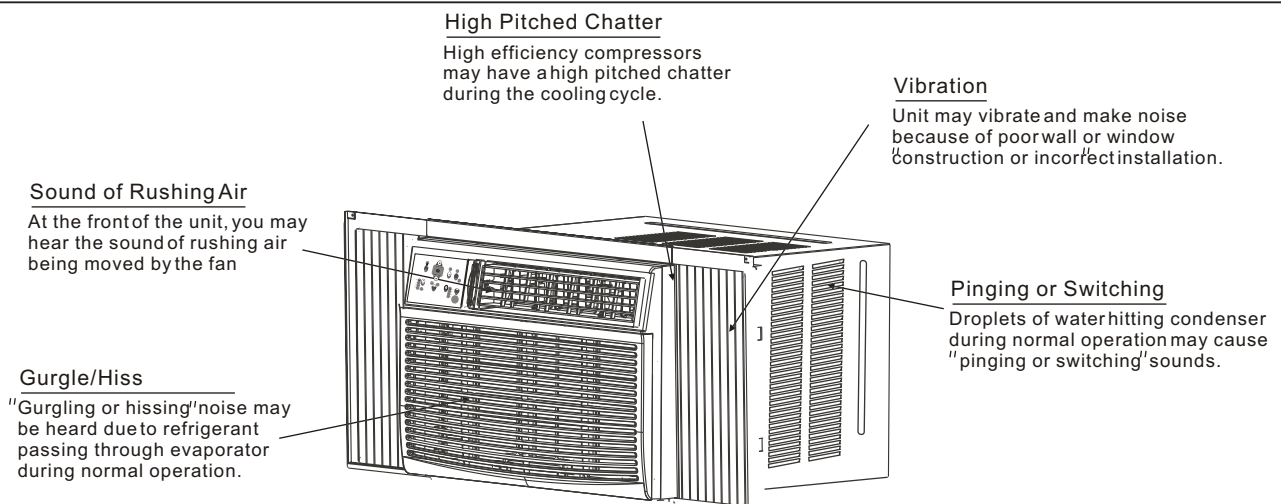

NOTE:

All the illustrations in this manual are for explanation purpose only. Your air conditioner may be slightly different. The actual shape shall prevail.

AIR CONDITIONER FEATURES

ELECTRONIC CONTROL OPERATING INSTRUCTIONS

Before you begin, thoroughly familiarize yourself with the control panel as shown below and all its functions, then follow the symbol for the functions you desire. **The unit can be controlled by the unit control alone or with the remote.**

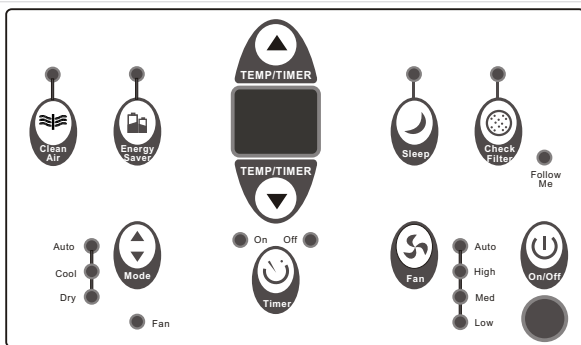

(Cooling Only Models)

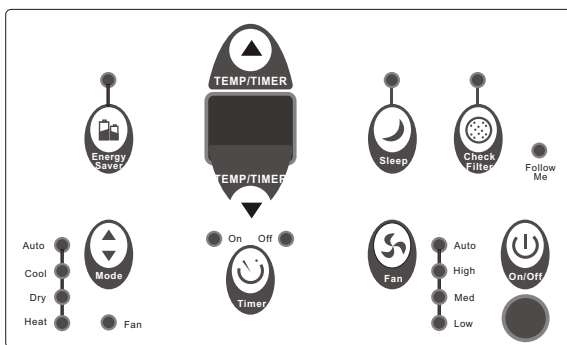

(Electric Heating models)

TO TURN UNIT ON OR OFF:

Press ON/OFF button to turn unit on or off.

NOTE: The unit will initiate automatically the Energy Saver function under Cool, Dry, Auto (only Auto-Cooling and Auto-Fan) modes.

TO CHANGE TEMPERATURE SETTING:

Press / UP/DOWN button to change temperature setting.

NOTE: Press or hold either UP () or DOWN () button until the desired temperature is seen on the display. This temperature will be automatically maintained anywhere between 62°F (17°C) and 86°F (30°C). If you want the display to read the actual room temperature, see To Operate on Fan Only section.

CLEAN AIR FEATURE: (on some models)

Press Clean Air button, the ion generator is energized and will help to remove pollen and impurities from the air, and trap them in the filter.

AIR CONDITIONER FEATURES

TO ADJUST FAN SPEEDS:

Press  to select the Fan Speed in four steps-Auto, Low, Med or High. Each time the button is pressed, the fan speed mode is shifted. For some models, the fan speed can not be adjusted under HEAT mode. On Dry mode, the fan speed is controlled at Low automatically.

SLEEP FEATURE:

Press  Sleep button to initiate the sleep mode. In this mode the selected temperature will increase (cooling) or decrease (heating) by 2°F/1(or 2)°C 30 minutes after the mode is selected. The temperature will then increase (cooling) or decrease (heating) by another 2°F/1(or 2)°C after an additional 30 minutes. This new temperature will be maintained for 6 hours before it returns to the originally selected temperature. This ends the Sleep mode and the unit will continue to operate as originally programmed. The Sleep mode program can be cancelled at any time during operation by pressing the Sleep button again.

CHECK FILTER FEATURE:

Press  Check filter button to initiate this feature. This feature is a reminder to clean the Air Filter for more efficient operation. The LED (light) will illuminate after 250 hours of operation. To reset after cleaning the filter, press the Check Filter button and the light will go off.

ENERGY SAVER FEATURE:

Press  Energy saver button to initiate this function. This function is available on COOL, DRY, AUTO (only AUTO-COOLING and AUTO-FAN) modes. The fan will continue to run for 3 minutes after the compressor shuts off. The fan then cycles on for 2 minutes at 10 minute intervals until the room temperature is above the set temperature, at which time the compressor turns back on and Cooling Starts.

FOLLOW ME FEATURE:(on some models)



Light flashing

This feature can be activated from the remote control ONLY. The remote control serves as a remote thermostat allowing for the precise temperature control at its location.

To activate the Follow Me feature, point the remote control towards the unit and press the Follow Me button. The remote display is actual temperature at its location. The remote control will send this signal to the air conditioner every 3 minutes interval until press the Follow Me button again. If the unit does not receive the Follow Me signal during any 7 minutes interval, the unit will beep to indicate the Follow Me mode has ended.

TO SELECT THE OPERATING MODE:

To choose operating mode, press  Mode button. Each time you press the button, a mode is selected in a sequence that goes from Auto, Cool, Dry, heat (cooling only models without) and Fan. The indicator light beside will be illuminated and remained on once the mode is selected.

The unit will initiate automatically the Energy Saver function under Cool, Dry, Auto (only Auto-Cooling and Auto-Fan) modes.

To operate on Auto feature:

- When you set the air conditioner in AUTO mode, it will automatically select cooling, heating (cooling only models without), or fan only operation depending on what temperature you have selected and the room temperature.
- The air conditioner will control room temperature automatically round the temperature point set by you.
- In this mode, the fan speed cannot be adjusted, it starts automatically at a speed according to the room temperature.

To operate on Fan Only:

- Use this function only when cooling is not desired, such as for room air circulation or to exhaust stale air (on some models). (Remember to open the vent during this function, but keep it closed during cooling for maximum cooling efficiency.) You can choose any fan speed you prefer.
- During this function, the display will show the actual room temperature, not the set temperature as in the cooling mode.
- In Fan only mode, the temperature is not adjusted.

To operate on Dry mode:

- In this mode, the air conditioner will generally operate in the form of a dehumidifier. Since the conditioned space is a closed or sealed area, some degree of cooling will continue.

TIMER: AUTO START/STOP FEATURE:

- When the unit is on or off, first press  Timer button, the TIMER ON indicator light illuminates. It indicates the Auto Start program is initiated.
- When the time of TIMER ON is displayed, press the Timer button again, the TIMER OFF indicator light illuminates. It indicates the Auto Stop program is initiated.
- Press or hold the UP or DOWN button to change the Auto time by 0.5 hour increments, up to 10 hours, then at 1 hour increments up to 24 hours. The control will count down the time remaining until start.
- The selected time will register in 5 seconds, and the system will automatically revert back to display the previous temperature setting or room temperature when the unit is on. (when the unit is off, there is no display.)
- Turning the unit ON or OFF at any time or adjusting the timer setting to 0.0 will cancel the Auto Start/Stop timed program.

AIR CONDITIONER FEATURES

DISPLAYS:

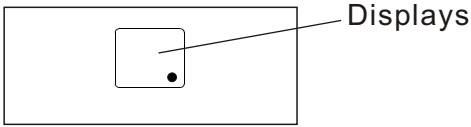

DISPLAYS:

Shows the set temperature in " °C" or " °F" and the Auto-timer settings. While on Fan only mode, it shows the room temperature.

Error codes:

AS-Room temperature sensor error-Unplug the unit and plug it back in.If error repeats, call for service.
NOTE:In Fan only mode,it will display "LO" or "HI".

- -Evaporator temperature sensor error-Unplug the unit and plug it back in.If error repeats, call for service.
NOTE: "•" is displayed as shown in the left picture.

HS -Electric heating sensor error-Unplug the unit and plug it back in.If error repeats, call for service.

NOTE:

If the unit breaks off unexpectedly due to the power cut, it will restart with the previous function setting automatically when the power resumes.

Air Directional Louvers

Air Directional Louvers

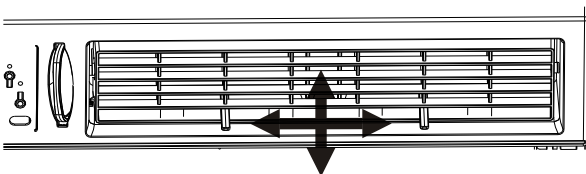

Air Direction(4-way)

The 4-way air directional louvers allow you to direct the air flow Up or Down(on some models) and Left or Right throughout the room as needed. To adjust the air directional louvers side-to-side, use the center handles as you move it side-to-side.

ADDITIONAL THINGS YOU SHOULD KNOW

Now that you have mastered the operating procedure, here are more features in your control that you should become familiar with.

- The Cool circuit has an automatic 3 minute time delayed start if the unit is turned off and on quickly. This prevents overheating of the compressor and possible circuit breaker tripping. The fan will continue to run during this time.
- The control is capable of displaying temperature in degrees Fahrenheit or degrees Celsius. To convert from one to the other, press and hold the Left and Right Temp/Timer buttons at the same time, for 3 seconds.

Fresh Air Vent Control

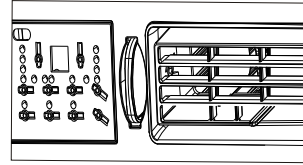

Fig. A (VENT CLOSED)

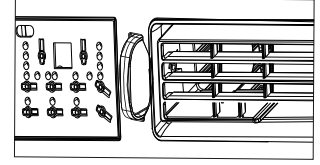

Fig. B (VENT OPEN)

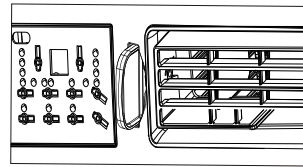

Fig. C (VENT & EXHAUST OPEN)

The Fresh Air Vent allows the air conditioner to:

1. Recirculate inside air - Vent Closed (See Fig.A)
2. Draw fresh air into the room- Vent Open (see Fig.B)
3. Exchange air from the room and draws fresh air into the room - Vent and Exhaust Open (see Fig.C)

CARE AND CLEANING

CAUTION

Clean your air conditioner occasionally to keep it looking new. **Be sure to unplug the unit before cleaning to prevent shock or fire hazards.**

Air Filter Cleaning

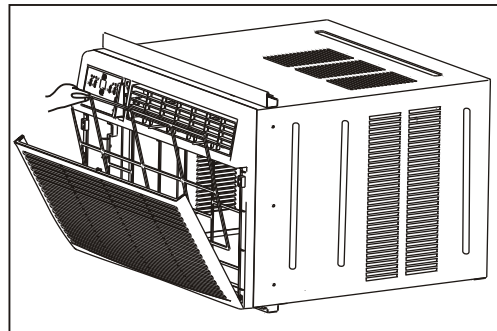

The air filter should be checked at least once a month to see if cleaning is necessary. Trapped particles in the filter can build up and cause an accumulation of frost on the cooling coils.

CARE AND CLEANING

Air Filter Cleaning

- Push the vent handle to the Vent Closed position (where applicable). Open the front panel.
- Take the filter by the center and pull up and out.
- Wash the filter using liquid dishwashing detergent and warm water. Rinse filter thoroughly. Gently shake excess water from the filter. Be sure the filter is thoroughly dry before replacing. Or, instead of washing you may vacuum the filter clean.

Note: Never use hot water over 40°C(104°F) to clean the air filter. Never attempt to operate the unit without the air filter.

Cabinet Cleaning

- Be sure to unplug the air conditioner to prevent shock or fire hazard. The cabinet and front may be dusted with an oil-free cloth or washed with a cloth dampened in a solution of warm water and mild liquid dishwashing detergent. Rinse thoroughly and wipe dry.
- Never use harsh cleaners, wax or polish on the cabinet front.
- Be sure to wring excess water from the cloth before wiping around the controls. Excess water in or around the controls may cause damage to the air conditioner.
- Plug in air conditioner.

Winter Storage

If you plan to store the air conditioner during the winter, remove it carefully from the window according to the installation instructions. Cover it with plastic or return it to the original carton.

TROUBLESHOOTING TIPS

Before calling for service, review this list. It may save your time and expense. This list includes common occurrences that are not the result of defective workman-ship or materials in this appliance.

Problem	Solution
Air conditioner does not start	<i>Wall plug disconnected. Push plug firmly into wall outlet.</i>
	<i>House fuse blown or circuit breaker tripped. Replace fuse with time delay type or reset circuit breaker.</i>
	<i>Plug Current Device Tripped. Press the RESET button.</i>
	<i>Power is OFF. Turn power ON.</i>
Air from unit does not feel cold enough	<i>Room temperature below 62°F(17°C). Cooling may not occur until room temperature rises above 62°F(17°C).</i>
	<i>Temperature sensing behind air filter element touching cold coil. Keep it from the cold coil.</i>
	<i>Set to a Lower temperature.</i>
	<i>Compressor stopped when changing modes. Wait for 3 minutes after set to the COOL mode.</i>
Air conditioner cooling, but room is too warm- ice forming on cooling coil behind decorative front.	<i>Outdoor temperature below 64°F(18°C). To defrost the coil, set FAN ONLY mode.</i>
	<i>Air filter may be dirty. Clean filter. Refer to Care and Cleaning section. To defrost, set to FAN ONLY mode.</i>
	<i>Thermostat set too cold for night-time cooling. To defrost the coil, set to FAN ONLY mode. Then, set temperature to a Higher setting.</i>

TROUBLESHOOTING TIPS

Problem	Solution
Air conditioner cooling, but room is too warm- NO ice forming on cooling coil behind decorative front.	<i>Dirty air filter- air restricted. Clean air filter. Refer to Care and Cleaning section.</i>
	<i>Temperature is set too High, set temperature to a Lower setting.</i>
	<i>Air directional louvers positioned improperly. Position louvers for better air distribution.</i>
	<i>Front of units is blocked by drapes, blinds, furniture, etc. - restricts air distribution. Clear blockage in front of unit.</i>
	<i>Doors, windows, registers, etc. Open- cold air escapes. Close doors, windows, registers.</i>
	<i>Unit recently turned on in hot room. Allow additional time to remove " Stored heat" from walls, ceiling, floor and furniture.</i>
Air conditioner turns on and off rapidly	<i>Dirty air filter- air restricted. Clean air filter.</i>
	<i>Outside temperature extremely hot. Set FAN speed to a Higher setting to bring air past cooling coils more frequently.</i>
Noise when unit is cooling	<i>Air movement sound. This is normal . If too loud, set to a slower FAN setting.</i>
	<i>Window vibration - poor installation. Refer to installation instructions or check with installer.</i>
Water dripping INSIDE when unit is cooling.	<i>Improper installation. Tilt air conditioner slightly to the outside to allow water drainage. Refer to installation instructions - check with installer.</i>
Water dripping OUTSIDE when unit is cooling.	<i>Unit removing large quantity of moisture from humid room. This is normal during excessively humid days.</i>
Remote Sensing Deactivating Prematurely (some models)	<i>Remote control not located within range. Place remote control within 20 feet & 180°, radius of the front of the unit.</i>
	<i>Remote control signal obstructed. Remove obstruction.</i>
Room too cold	<i>Set temperature too low. Increase set temperature.</i>

The design and specifications are subject to change without prior notice for product improvement. Consult with the sales agency or manufacturer for details.

2020001B6619