

# **INSTALLATION & OPERATION MANUAL**

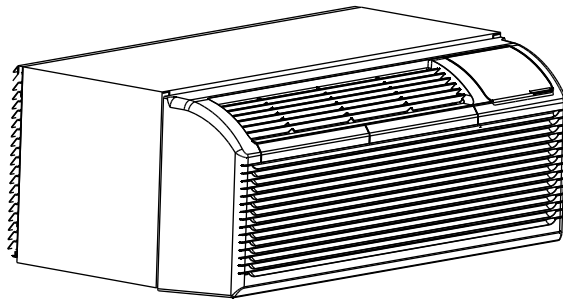

## **PACKAGED TERMINAL AIR CONDITIONER/HEAT PUMP**



**Before using your air conditioner, please read  
this manual carefully and keep it for future reference.**





MIDEA AMERICA CORPORATION  
PRODUCT REGISTRATION CENTER  
11800 NW 100 ROAD STE 4  
MEDLEY FL 33178-1037



PLACE  
STAMP  
HERE

Postage  
Required.  
Post Office will  
not deliver  
without proper  
postage.

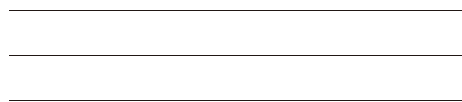
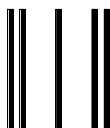

## Product Warranty Card

### Air conditioner warranty

Your product is protected by this warranty:  
Your appliance is warranted by Midea. Any obligations for services and parts under this warranty must be performed by Midea Consumer Services or an authorized Midea servicer  
To contact a Customer Service Representative, Call Midea TOLL FREE

1-866-646-4332®

# CONTENTS

1. SAFETY PRECAUTIONS.....	2
2. IMPORTANT SAFETY INSTRUCTIONS .....	4
3. AIR CONDITIONER FEATURES.....	5
4. CONTROL PANEL OPERATION.....	6
5. INSTALLATION .....	7
6. CARE AND CLEANING.....	9
7. TROUBLESHOOTING.....	10

## Read This Manual



Inside you will find many helpful hints on how to use and maintain your air conditioner properly. Just a little preventive care on your part can save you a great deal of time and money over the life of your air conditioner. You'll find many answers to common problems in the chart of troubleshooting tips. If you review our chart of Troubleshooting Tips first, you may not need to call for service at all.

### CAUTION



- This appliance can be used by children aged from 8 years and above and persons with reduced physical, sensory or mental capabilities or lack of experience and knowledge if they have been given supervision or instruction concerning use of the appliance in a safe way and understand the hazards involved. Children shall not play the appliance. Cleaning and user maintenance shall not be made by children without supervision. ( be applicable for the European Countries )
- This appliance is not intended for use by persons (including children) with reduced physical ,sensory or mental capabilities or lack of experience and knowledge, unless they have been given supervision or instruction concerning use of the appliance by a person responsible for their safety. (be applicable for other countries except the European Countries )
- Children should be supervised to ensure that they do not play with the appliance.
- If the supply cord is damaged, it must be replaced by the manufacturer, its service agent or similarly qualified persons in order to avoid a hazard.
- The appliance shall be installed in accordance with national wiring regulations.
- Do not operate your air conditioner in a wet room such as a bathroom or laundry room.
- The appliance with electric heater shall have at least 1 meter space to the combustible materials.
- Contact the authorised service technician for repair or maintenance of this unit.
- Contact the authorised installer for installation of this unit.

# SAFETY PRECAUTIONS

To prevent injury to the user or other people and property damage, the following instructions must be followed. Incorrect operation due to ignoring of instructions may cause harm or damage. The seriousness is classified by the following indications.

 <b>WARNING</b>	This symbol indicates the possibility of death or serious injury.
 <b>CAUTION</b>	This symbol indicates the possibility of injury or damage to property.

■ Meanings of symbols used in this manual are as shown below.

	<b>Never do this.</b>
	<b>Always do this.</b>

## WARNING

ⓘ Plug in power plug properly.

- Otherwise, it may cause electric shock or fire due to excess heat generation.

ⓘ Do not operate or stop the unit by inserting or pulling out the power plug.

- It may cause electric shock or fire due to heat generation.

ⓘ Do not damage or use an unspecified power cord.

- It may cause electric shock or fire.
- If the power cord is damaged, it must be replaced by the manufacturer or an authorised service centre or a similarly qualified person in order to avoid a hazard.

ⓘ Do not modify power cord length or share the outlet with other appliances.

- It may cause electric shock or fire due to heat generation.

ⓘ Do not operate with wet hands or in damp environment.

- It may cause electric shock.

ⓘ Do not direct airflow at room occupants only.

- This could damage your health.

ⓘ Always ensure effective earthing.

- Incorrect earthing may cause electric shock.

ⓘ Do not allow water to run into electric parts.

- It may cause failure of machine or electric shock.

ⓘ Always install circuit breaker and a dedicated power circuit.

- Incorrect installation may cause fire and electric shock.

ⓘ Unplug the unit if strange sounds, smell, or smoke comes from it.

- It may cause fire and electric shock.

ⓘ Do not use the socket if it is loose or damaged.

- It may cause fire and electric shock.

ⓘ Do not open the unit during operation.

- It may cause electric shock.

ⓘ Keep firearms away.

- It may cause fire.

ⓘ Do not use the power cord close to heating appliances.

- It may cause fire and electric shock.

ⓘ Do not use the power cord near flammable gas or combustibles, such as gasoline, benzene, thinner, etc.

- It may cause an explosion or fire.

ⓘ Ventilate room before operating air conditioner if there is a gas leakage from another appliance.

- It may cause explosion, fire and, burns.

ⓘ Do not disassemble or modify unit.

- It may cause failure and electric shock.



## CAUTION

ⓘ When the air filter is to be removed, do not touch the metal parts of the unit.

- It may cause an injury.

ⓘ When the unit is to be cleaned, switch off, and turn off the circuit breaker.

- Do not clean unit when power is on as it may cause fire and electric shock, it may cause an injury.

ⓘ Stop operation and close the window in storm or hurricane.

- Operation with windows opened may cause wetting of indoor and soaking of household furniture.

ⓘ Do not place obstacles around air-inlets or inside of air-outlet.

- It may cause failure of appliance or accident.

ⓘ Do not use strong detergent such as wax or thinner but use a soft cloth.

- Appearance may be deteriorated due to change of product color or scratching of its surface.

ⓘ Use caution when unpacking and installing. Sharp edges could cause injury.

ⓘ Clean the evaporator once every three months by professional people.

- Otherwise it may cause failure of electric heating feature.

ⓘ Do not clean the air conditioner with water.

- Water may enter the unit and degrade the insulation. It may cause an electric shock.

ⓘ Do not put a pet or house plant where it will be exposed to direct air flow.

- This could injure the pet or plant.

ⓘ Hold the plug by the head of the power plug when taking it out.

- It may cause electric shock and damage.

ⓘ Ensure that the installation bracket of the outdoor appliance is not damaged due to prolonged exposure.

- If bracket is damaged, there is concern of damage due to falling of unit.

ⓘ Do not place heavy object on the power cord and ensure that the cord is not compressed.

- There is danger of fire or electric shock.

ⓘ Ventilate the room well when used together with a stove, etc.

- An oxygen shortage may occur.

ⓘ Do not use for special purposes.

- Do not use this air conditioner to preserve precision devices, food, pets, plants, and art objects. It may cause deterioration of quality, etc.

ⓘ Turn off the main power switch when not using the unit for a long time.

- It may cause failure of product or fire.

ⓘ Always insert the filters securely. Clean filter once every two weeks.

- Operation without filters may cause failure.

ⓘ Do not drink water drained from air conditioner.

- It contains contaminants and could make you sick.

ⓘ If water enters the unit, turn the unit off at the power outlet and switch off the circuit breaker. Isolate supply by taking the power-plug out and contact a qualified service technician.

# IMPORTANT SAFETY INSTRUCTIONS

**NOTE** The power supply cord with this air conditioner contains a current detection device designed to reduce the risk of fire. Please refer to the section 'Operation of Current Device' for details. In the event that the power supply cord is damaged, it cannot be repaired-it must be replaced with a cord from the Product Manufacturer.

## **⚠ WARNING For your safety**

- Do not store or use gasoline or other flammable vapors and liquids in the vicinity of this or any other appliance.
- Avoid fire hazard or electric shock. Do not use an extension cord or an adaptor plug. Do not remove any prong from the power cord.

## **⚠ WARNING Electrical Information**

- Be sure the electrical service is adequate for the model you have chosen. This information can be found on the serial plate, which is located on the side of the cabinet and behind the grille.
- Be sure the air conditioner is properly grounded. To minimize shock and fire hazards, proper grounding is important. The power cord is equipped with a three-prong grounding plug for protection against shock hazards.
- Your air conditioner must be used in a properly grounded wall receptacle. If the wall receptacle you intend to use is not adequately grounded or protected by a time delay fuse or circuit breaker, have a qualified electrician install the proper receptacle.
- Ensure the receptacle is accessible after the unit installation.
- Do not run air conditioner without side protective cover in place. This could result in mechanical damage within the air conditioner.  
**Do not use an extension cord or an adapter plug.**

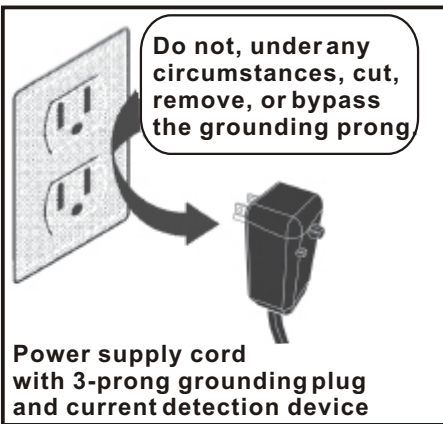

**NOTE:**

The shape may be different according to its model:

Power Card						
Power Supply	230V,15A	230V,20A	230V,30A	265V,15A	265V,20A	265V,30A



## Operation of Current Device(optional)

The power supply cord contains a current device that senses damage to the power cord. To test your power supply cord do the following:

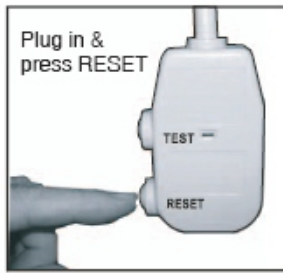

NOTE: Some plugs have buttons on the top.

### NOTES:

- Do not use this device to turn the unit on or off.
- Always make sure the RESET button is pushed in for correct operation.
- The power supply must be replaced if it fails reset when either the TEST button is pushed, or it cannot be reset. A new one can be obtained from the product manufacturer.
- If power supply cord is damaged, it cannot be repaired. It MUST be replaced by one obtained from the product manufacturer.
- When 265V units are to be installed, the power supply must be permanent wiring. Permanent wiring may be done through the accessory subbase. An exposed cord connection on 265V units are not permitted.

1. Plug in the Air Conditioner.
2. The power supply cord will have TWO buttons on the plug head. Press the TEST button, you will notice a click as the RESET button pops out.
3. Press the RESET button, again you will notice a click as the button engages.
4. The power supply cord is now supplying electricity to the unit.  
(On some products this it also indicated by a light on the plug head.)

## AIR CONDITIONER FEATURES

This unit has many features. The servicer must be familiar with these features in order to properly service the unit.

### • Compressor Restart Delay

This feature extends the overall life of compressor by preventing the short-cycling of the air conditioner. When the compressor restarts, the unit is designed to give a minimum of three minutes to have a time of equalizing the refrigerant pressures for optimizing cycling.

### • Memory

The unit has memory. If power is lost, all of the control settings (mode, fan speed, on/off and configuration) are remembered. So when power is restored, the unit will start back up in the mode (and configuration) it was in, when power was lost.

### • Automatic Evaporator Freeze Protection

Automatically to keep the evaporator from freezing, the compressor is turned off and the indoor fan is turned on when the evaporator temperature is too lower. If the evaporator temperature is not too lower this function is off.

### • Automatic Quick Warm-up (for heat pump models only)

If the room temperature falls to 4.5°C/8°F below the set point temperature, the reverse cycle heat is shut off and the electric strip heat is turned on for one cycle, until heating is satisfied.

### • LED Indicators and Buttons

The touch pad has buttons for MODE, FAN, POWER, SETPOINT UP and SETPOINT DOWN. It also has LEDs that correspond to the mode, fan speed, power and setpoint operation, to indicate the unit's status. LEDs for HIGH, MED and LOW indicate the fan speed that is selected. LEDs for FAN, COOL and HEAT indicate what operating mode is active. LED for POWER is the unit ON/OFF status LED. If the unit is in ON mode, the LED will be green. If the unit is OFF, the LED will be off.

NOTE: HEAT mode is for Cooling & Heating models only.

### • High Temperature Protection In Heating Operation

The compressor and (or) electric heater will be switched off to prevent damage in high indoor blow air temperature or error indoor temperature sensor.

### • Unit Configuration

°F or °C

The unit can display in either °F or °C.

# CONTROL PANEL OPERATION

The control panel keypad will look like the following Fig.1:

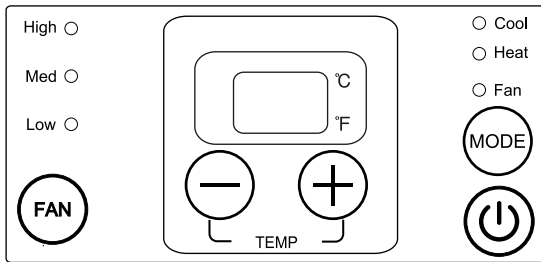

Fig.1

## ● POWER

- Press the POWER button to turn the unit on or off. When the unit is on, the power indicator light will be green. When the unit is off, the light will go out.

## ● MODE

- Push this button to cycle through the modes from COOL-HEAT-FAN-COOL. The indicator light beside the "MODE" option will illuminate, identifying the mode selected.
- COOL: The range of set temperature is 17°C/62°F ~30°C/86°F. Cooling begins automatically when the room temperature is above the set point, and stops when the room temperature is 2°C(4°F) below the set point. But the compressor will run 5 minutes at least in COOL mode before stopping. The fan runs in continuous mode.
- HEAT: The range of set temperature is 17°C/62°F ~29°C/84°F. For heat pump models, the unit can alternate to run between in reverse cycle heat mode and electric heater mode according to the difference between the setting temperature and the room temperature. The fan motor cycles on and off with the compressor and electric heater.

NOTE:

The reverse cycle and electric heater cannot be run at the same time. In following cases, it is normal that the reverse cycle does not operate.

1. When the outdoor temperature is lower than 4°C/40°F or the room temperature falls to 4.5°C/8°F below the set point temperature.
2. There is a 3-minute minimum compressor run time at any setting to prevent short cycling. The indoor fan motors start before the compressor and stop after the compressor cycles off.
3. When frost builds up to the evaporator coils, the unit will defrost automatically and the compressor will cycle off.

- FAN: Fan operation only without heating and cooling.

## ● UP/DOWN BUTTONS ( + / - )

- Push the UP (or DOWN) button to increase (or decrease) the set temperature of the unit in cooling or heating mode. The temperature can be set by increments of 1°C (1°F). The setting temperature appears in the display.
- NOTE: Press and hold "+" and "-" buttons together for 3 seconds will alternate the temperature display between "°C" & "°F" scale.

## ● FAN (FAN SPEED)

- Every time you push this button, the fan speed cycles through the settings as follows: HIGH-MED-LOW-HIGH.

## ● DISPLAYS:

- Shows the set temperature in °C or °F. While on Fan only mode, it shows the room temperature.

**Control code (on some models):**

**LC-** Pads on the control panel is not available. The unit can be set by using wire controller only.

**Error codes:**

**AS-** Room temperature sensor error;

**ES-** Evaporator temperature sensor error;

**CS-** Condenser temperature sensor error;

**OS-** Outside temperature sensor error;

**HS-** Exhaust temperature sensor error;

NOTE: When error occurs, unplug the unit and plug it back in. If error repeats, call for service.

**Other codes:**

**LO-** Room temperature is lower than 0°C/32°F;

**HI-** Room temperature is higher than 37°C/99°F.

**NOTE:** All the illustrations in this manual are for explanation purpose only. Your air conditioner may be slightly different. The actual shape shall prevail.

**NOTE:** This air conditioner is designed to be operated under condition as follows:

Cooling operation	Outdoor temp:	18-43°C/64-109°F (18-52°C/64-125°F for special tropical models)
	Indoor temp:	17-32°C/62-90°F
Heating operation	Outdoor temp:	-5-24°C/23-76°F
	Indoor temp:	0-27°C/32-80°F

Note: Performance may be reduced outside of these operating temperatures.

# INSTALLATION

## ● HOW TO INSTALL THE UNIT

### ⚠ CAUTION

- There are sharp edges that can cause serious cuts.
- When lifting the air conditioner, it is HEAVY. Use 2 people to lift.

- For existing sleeve, you should measure the wall sleeve dimensions.
- Install the new air conditioner according to these installation instructions to achieve the best performance. All wall sleeves used to mount the new air conditioner must be in good structural condition and have a rear grille that securely attaches to the sleeve or the flange of the sleeve to secure the new air conditioner.
- To avoid vibration and noise, make sure the unit is installed securely and firmly.
- When installing the sleeve, make certain there is nothing within 20" of the back that would interfere with heat radiation and exhaust air flow. (See Fig.2)

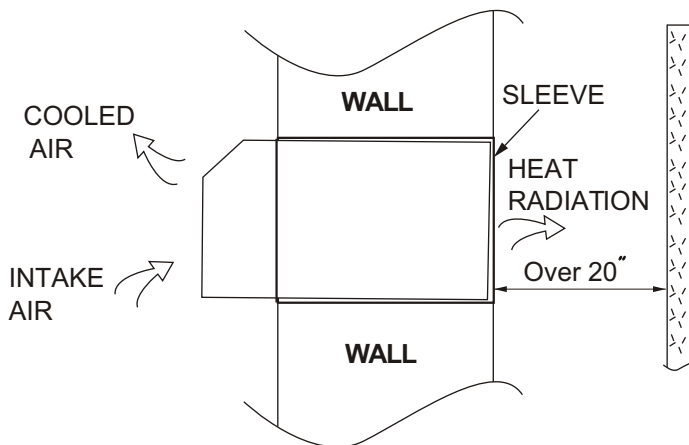

Fig.2

## ● PREPARATION OF SLEEVE ASSEMBLY (optional)

- Refer to the installation instruction of sleeve assembly for details.

## ● PREPARATION OF REAR GRILLE ASSEMBLY (optional)

- Refer to the installation instruction of rear grille assembly for details.

## ● UNIT INSTALLATION

- Carefully remove shipping tapes from the front panel. (See Fig.3)
- Remove the front panel. (See Fig.4)
- Remove the shipping screw from the vent door. (See Fig.5)

## Dimension of air conditioner

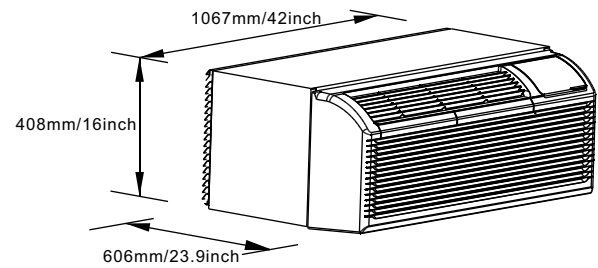

## Dimension of sleeve assembly (optional)

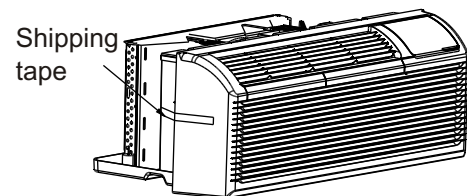
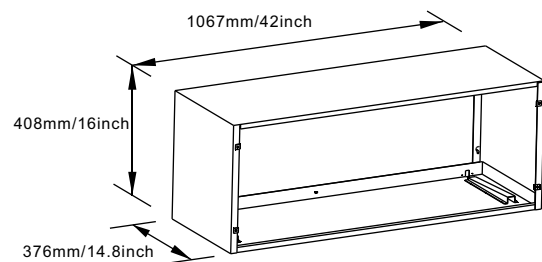
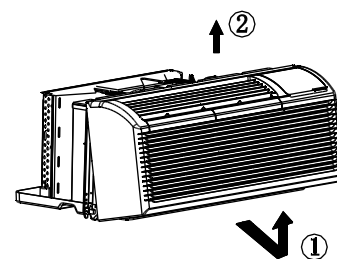

Fig.3



- Pull out at the bottom to release it from the tabs ①.
- Then lift up ②.

Fig.4

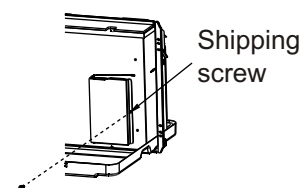

Fig.5

# INSTALLATION (CONTINUED)

## ● UNIT INSTALLATION (CONTINUED)

- Rotate the vent control lever to either open or close the vent door.(See Fig.6)

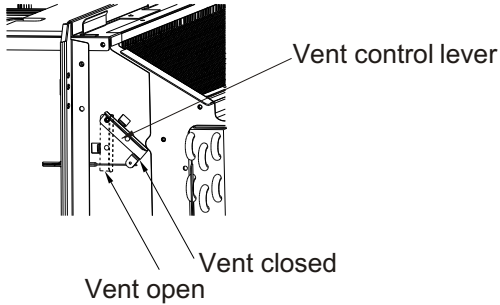

Fig.6

NOTE:When vent control lever set at CLOSE,only the air inside the room is circulated and filtered. When set at OPEN,some outdoor air will be drawn into room.This will reduce heating or cooling efficiency.

- Lift unit level and slide unit into wall sleeve until firmly against front of wall sleeve and secure with 4 screws and washers (supplied in the SLEEVE ASSEMBLY ) through the unit flange holes. (See Fig.7 and Fig.8)

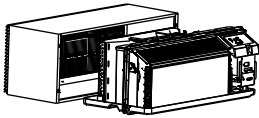

Fig.7

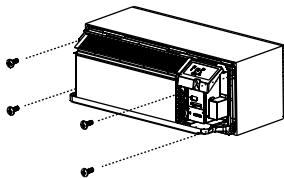
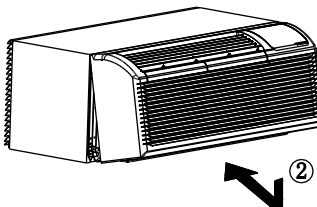

Fig.8

- Reinstall front panel.(See Fig.9)



Place tabs over top rail ① . Push Inward at bottom until panel snaps into place ② .

Fig.9

## ⚠ CAUTION

- Do not put obstacles around air-inlet or inside of air-outlet of the unit, such as window curtain etc.
- Always insert the filter securely, clean filter once every two weeks as required.

# CARE AND CLEANING

## ● FRONT PANEL AND CASE

- Turn unit off and disconnect power supply. To clean, use water and a mild detergent. **DO NOT** use bleach and abrasives. Some commercial cleaners may damage the plastic parts.

## ● OUTDOOR COIL

- Coil on outdoor side of unit should be checked regularly. Unit will need to be removed to inspect dirt build-up that will occur on the inside of the coil. If clogged with dirt and soot, coil should be professionally cleaned. Clean inside and outside of outdoor coils regularly.

**NOTE:** Never use a high-pressure spray on coil.

## ⚠ CAUTION

### UNIT DAMAGE HAZARD

Failure to follow this caution may result in equipment damage or improper operation. Airflow restriction may cause damage to the unit.

## ● AIR FILTERS

**IMPORTANT: TURN UNIT OFF BEFORE CLEANING.**

## ⚠ CAUTION

### UNIT DAMAGE HAZARD

Failure to follow this caution may result in equipment damage or improper operation.

- **Do not** operate unit without filters in place. If a filter becomes torn or damaged, it should be replaced immediately.
- Operating without filters in place or with damaged filter will allow dirt and dust to reach indoor coil and reduce cooling, heating, airflow and efficiency of unit. Airflow restriction may cause damage to unit.

- The most important thing you can do to maintain unit efficiency is to clean the filters once every two weeks as required. Clogged filters reduce cooling, heating and airflow.

### - Keeping filters clean will:

- Decrease cost of operation.
- Save energy.
- Prevent clogged indoor coil.
- Reduce risk of premature component failure.

### - To Clean Air Filters:

- Vacuum off heavy soil.
- Run water through filter.
- Dry thoroughly before replacing.

## - Removing Air Filter

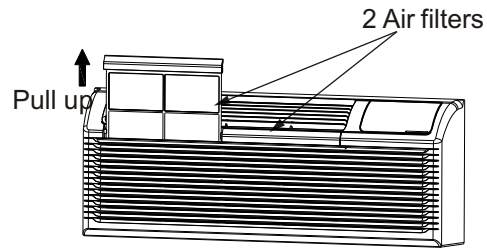

Fig.9

## - Replacing Air Filter

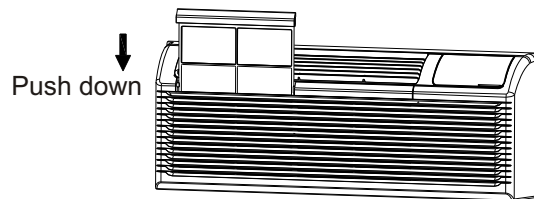

Fig.10

## ● VENT DOOR FILTER

**IMPORTANT: TURN UNIT OFF BEFORE CLEANING.**

- If the vent door is open, access requires the removal of the unit from the wall sleeve. Clean the vent filter twice a year or as required.
- Make sure to remove the shipping screw from the vent door. (See Fig.5)
- Rotate the vent control lever to open the vent door. (See Fig.6)
- Remove four screws from the vent door filter. (See Fig.11)
- First pull out the vent door steel wire from the hole of the vent door, then take off the vent door and filter. (See Fig.11)
- Clean the filter. Dry thoroughly before replacing.
- Replac the vent door and filter, reinstall the four screws.
- Reinsert the vent door steel wire into the hole of the vent door.

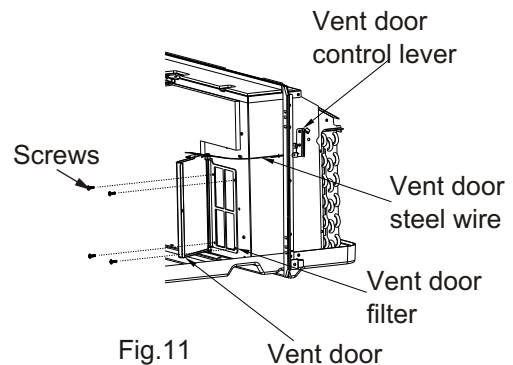

Fig.11

# TROUBLESHOOTING

POSSIBLE CAUSES	SOLUTIONS
<p><b>UNIT DOES NOT START</b></p> <ul style="list-style-type: none"> <li>● Unit may have become unplugged</li> <li>● Fuse may have blown</li> <li>● Circuit breaker may have been tripped</li> <li>● Unit may be off</li> <li>● Unit may be in a protection mode.</li> </ul>	<ul style="list-style-type: none"> <li>● Check that plug is plugged securely in wall receptacle. <b>Note:</b> Plug has a test/reset button on it. Make sure that the plug has not tripped.</li> <li>● Replace the fuse. See Note 1.</li> <li>● Reset circuit breaker. See Note 1.</li> <li>● Turn unit on (bottom right button on keypad).</li> </ul>
<p><b>UNIT NOT COOLING/HEATING ROOM</b></p> <ul style="list-style-type: none"> <li>● Unit air discharge section is blocked</li> <li>● Temperature setting is not high or low enough</li> </ul> <p><b>Note:</b> Setpoint limits may not allow the unit to heat or cool the room to the temperature desired. Check section on dipswitch settings.</p> <ul style="list-style-type: none"> <li>● Unit air filters are dirty.</li> <li>● Room is excessively hot or cold when unit is started.</li> <li>● Vent door left open.</li> <li>● Unit may be in a protection mode.</li> <li>● Compressor is in time delay.</li> </ul>	<ul style="list-style-type: none"> <li>● Make sure that curtains, blinds or furniture are not restricting or blocking unit airflow.</li> <li>● Reset to a lower or higher temperature setting.</li> <li>● Remove and clean filters.</li> <li>● Allow sufficient amount of time for unit to heat or cool the room. Start heating or cooling early before outdoor temperature, cooking heat or gatherings of people make room uncomfortable.</li> <li>● Close vent door.</li> <li>● Check dipswitch settings for desired comfort.</li> <li>● Wait approximately 3 minutes for compressor to start.</li> </ul>
<p><b>DISPLAY HAS STRANGE NUMBERS/CHARACTERS ON IT</b></p>	<ul style="list-style-type: none"> <li>● The unit may be in a protection mode.</li> <li>● The unit may be set for °C (instead of °F).</li> </ul>
<p><b>UNIT MAKING NOISES</b></p>	<ul style="list-style-type: none"> <li>● Clicking, gurgling and whooshing noises are normal during operation of unit.</li> </ul>
<p><b>WATER DRIPPING OUTSIDE</b></p>	<ul style="list-style-type: none"> <li>● If a drain kit has not been installed, condensation runoff during very hot and humid weather is normal. See Note 2. If a drain kit has been installed and is connected to a drain system, check gaskets and fittings around drain for leaks and plugs.</li> </ul>
<p><b>WATER DRIPPING INSIDE</b></p> <ul style="list-style-type: none"> <li>● Wall sleeve is not installed level</li> </ul>	<ul style="list-style-type: none"> <li>● Wall sleeve must be installed level for proper drainage of condensation. Check that installation is level and make any necessary adjustments.</li> </ul>
<p><b>ICE OR FROST FORMS ON INDOOR COIL</b></p> <ul style="list-style-type: none"> <li>● Low outdoor temperature</li> <li>● Dirty filters</li> </ul>	<ul style="list-style-type: none"> <li>● When outdoor temperature is approximately 55°F or below, frost may form on the indoor coil when unit is in Cooling mode. Switch unit to FAN operation until ice or frost melts.</li> <li>● Remove and clean filters.</li> </ul>
<p><b>COMPRESSOR PROTECTION</b></p> <ul style="list-style-type: none"> <li>● Power may have cycled, so compressor is in a restart protection.</li> </ul>	<ul style="list-style-type: none"> <li>● <b>Random Compressor restart</b>-Whenever the unit is plugged in, or power has been restarted, a random compressor restart will occur. After a power outage, the compressor will restart after approximately 3 minutes.</li> <li>● <b>Compressor Protection</b>-To prevent short cycling of the compressor, there is a random startup delay of 3 minutes and a minimum compressor run time of 3 minutes.</li> </ul>
<p><b>ELECTRIC HEATING FAILURE</b></p>	<ul style="list-style-type: none"> <li>● Clean the evaporator once every three months by professional people.</li> </ul>

**NOTES:**

1. If circuit breaker is tripped or fuse is blown more than once, contact a qualified electrician.
2. If unit is installed where condensation drainage could drip in an undesirable location, an accessory drain kit should be installed and connected to drain system.



The design and specifications are subject to change without prior notice for product improvement. Consult with the sales agency or manufacturer for details.

**2020001B6504**