

2175.500 Shown

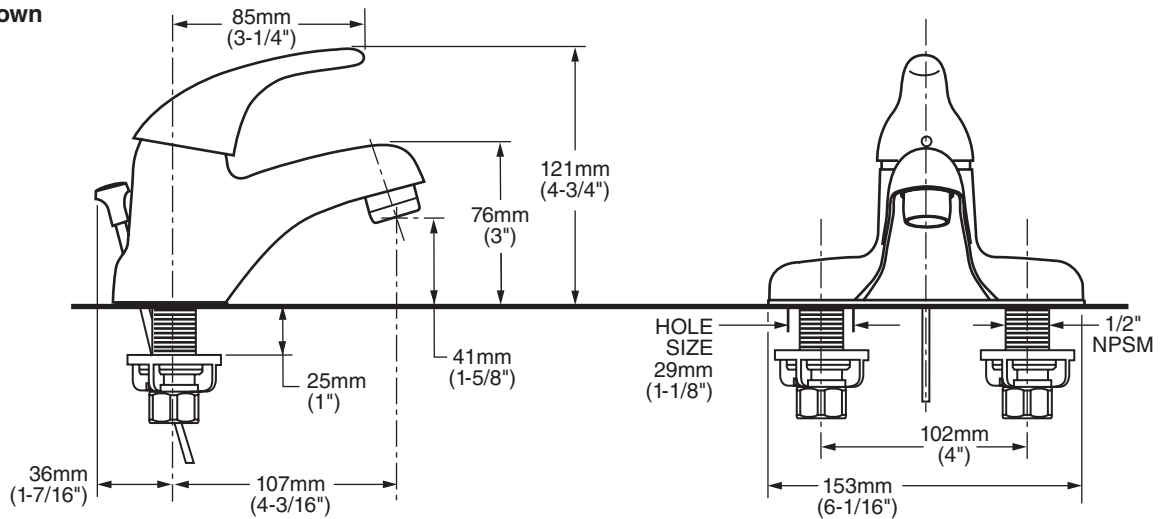

GENERAL DESCRIPTION:

Single control lavatory faucet on 4" centers. Washerless 40mm ceramic disc valve cartridge with integral hot limit safety stop. Durable cast brass waterway with 1/2" male threaded brass inlet shanks. Metal body with color matched underbody. Metal lever handle with large "comfort zone." 1.5 gpm/5.7L/min. maximum flow rate.

PRODUCT FEATURES:

Cast Brass Waterways with "City Shanks": Strong and durable. Integral tabs on casting provide a wobble-free installation.

Ceramic Disc Valve Cartridge: Assures a lifetime of drip-free performance.

Adjustable Hot Limit Safety Stop: Limits the amount of hot water allowed to mix with cold. Reduces the risk of accidental scalding.

Lead Free: Faucet contains ≤ 0.25% total lead content by weighted average.

Longer Spout: Provides extended reach into lavatory.

Memory Position Valving: Allows user to turn valve on and off at preferred temperature setting without readjusting handle position each time.

Large "Comfort Zone": Allows easy fine tuning of temperature.

Simple Installation: Fast and easy one person installation. Faucet drops in from top. Quick spin nuts secure faucet in place.

SUGGESTED SPECIFICATION:

Single control lavatory fitting shall feature cast brass waterways with 1/2" male inlet shanks. Shall also feature washerless 40mm ceramic disc valve cartridge with integral hot limit safety stop. Fitting shall be American Standard Model # 2175.____.____.

CODES AND STANDARDS

These products meet or exceed the following codes and standards:



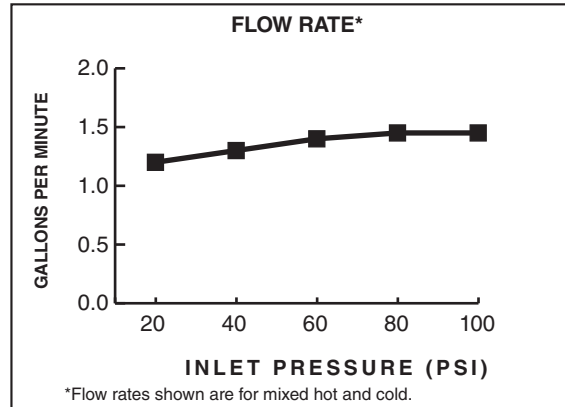



- ANSI A117.1**
- ASME A112.18.1**
- NSF 61/Section 9 and Annex G**
- CSA B 125**



Product Number	Description	Finish Options	
		Polished Chrome	PVD Satin Nickel
		002	295
2175.500	Colony Soft Single Control Centerset. 50/50 Pop-up drain.		
2175.506	Colony Soft Single Control Centerset. Grid drain. Less pop-up rod and hole.		N/A
2175.505	Colony Soft Single Control Centerset. Less drain. With pop-up rod and hole.		N/A
2175.504	Colony Soft Single Control Centerset. Less drain. Less pop-up rod and hole.		N/A

N/A = Not Available

 Meets the American Disabilities Act Guidelines and **ANSI A117.1** Requirements for the physically challenged.

Available Modifications*		Part Suffix	
Flow Control Options		Non-Aerated 0.5gpm/1.9L/min. PCA Spray	__F05
		Vandal-Resistant Non-Aerated 0.5gpm/1.9L/min. PCA Spray	__V05
		1.0gpm/3.8L/min. PCA Aerator	__F10
		Vandal-Resistant 1.0gpm/3.8L/min. PCA Aerator	__V10
		Vandal-Resistant 1.5gpm/5.7L/min. PCA Aerator	__V15
		Non-Aerated Laminar PCA 1.5gpm/5.7L/min. Flow Outlet	__L15

*Modified product models are NOT Water Sense certified.