



No.:

Date: 27-DEC-2012

Customer :

TECHNICAL PROPOSAL

Three-phase induction motor - Squirrel cage rotor

Product line : Three-Phase: W22 IEEE-841™ Petrochem Motors - NEMA Premium® Efficiency

Catalog Number : 03018ST3QIE286T-W22

List Price : \$3,509

Notes:

Performed by:

Checked:



No.:

Date: 27-DEC-2012

DATA SHEET

Three-phase induction motor - Squirrel cage rotor

Customer :
Product line : Three-Phase: W22 IEEE-841™ Petrochem Motors - NEMA Premium® Efficiency

Frame : 286T
Output : 30 HP
Frequency : 60 Hz
Poles : 4
Full load speed : 1765
Slip : 1.94 %
Voltage : 460 V
Rated current : 35.1 A
Locked rotor current : 214 A
Locked rotor current (I_L/I_n) : 6.1
No-load current : 11.0 A
Full load torque : 88.1 lb.ft
Locked rotor torque : 240 %
Breakdown torque : 240 %
Design : B
Insulation class : F
Temperature rise : 80 K
Locked rotor time : 20 s (hot)
Service factor : 1.25
Duty cycle : S1
Ambient temperature : -20°C - +40°C
Altitude : 1000
Degree of Protection : IP55
Approximate weight : 437 lb
Moment of inertia : 5.8532 sq.ft.lb
Noise level : 64 dB(A)

	D.E.	N.D.E.	Load	Power factor	Efficiency (%)
Bearings	6311 C3	6211 C3	100%	0.84	93.6
Regreasing interval	20000 h	20000 h	75%	0.80	93.0
Grease amount	18 g	11 g	50%	0.70	93.0

Notes:

Performed by

Checked



No.:

Date: 27-DEC-2012

PERFORMANCE CURVES RELATED TO RATED OUTPUT

Three-phase induction motor - Squirrel cage rotor

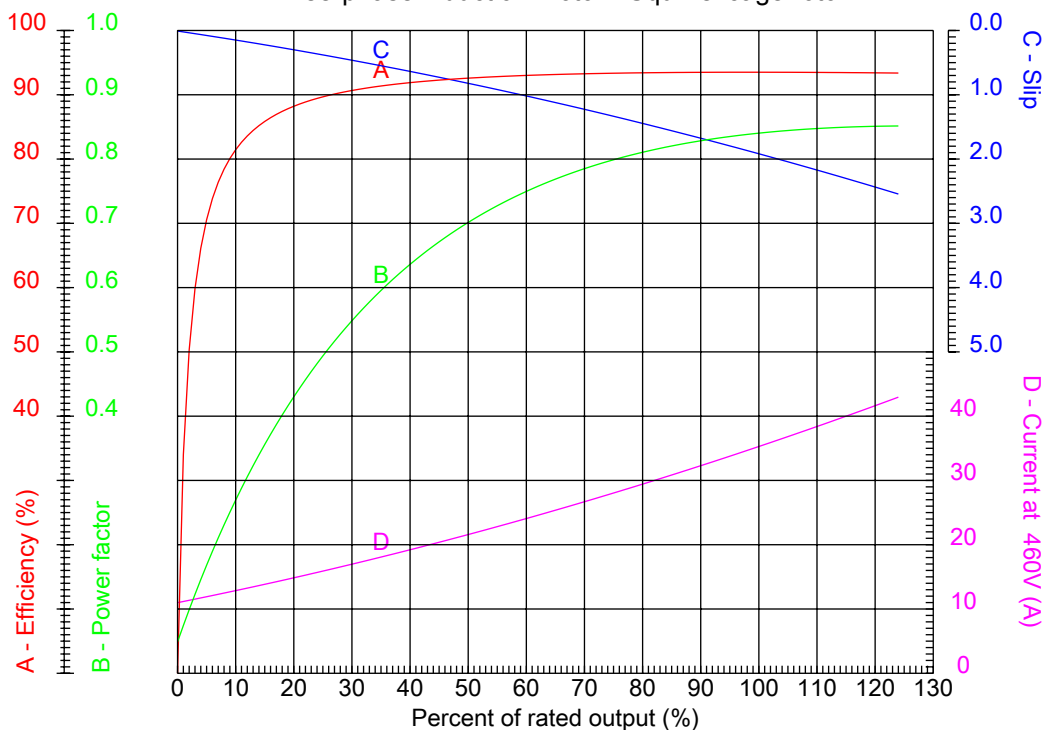

Customer :
Product line : Three-Phase: W22 IEEE-841™ Petrochem Motors - NEMA Premium® Efficiency

Frame	: 286T	Locked rotor current (I _L /I _n)	: 6.1
Output	: 30 HP	Duty cycle	: S1
Frequency	: 60 Hz	Service factor	: 1.25
Full load speed	: 1765	Design	: B
Voltage	: 460 V	Locked rotor torque	: 240 %
Rated current	: 35.1 A	Breakdown torque	: 240 %
Insulation class	: F		

Notes:

Performed by

Checked



No.:

Date: 27-DEC-2012

CHARACTERISTIC CURVES RELATED TO SPEED

Three-phase induction motor - Squirrel cage rotor

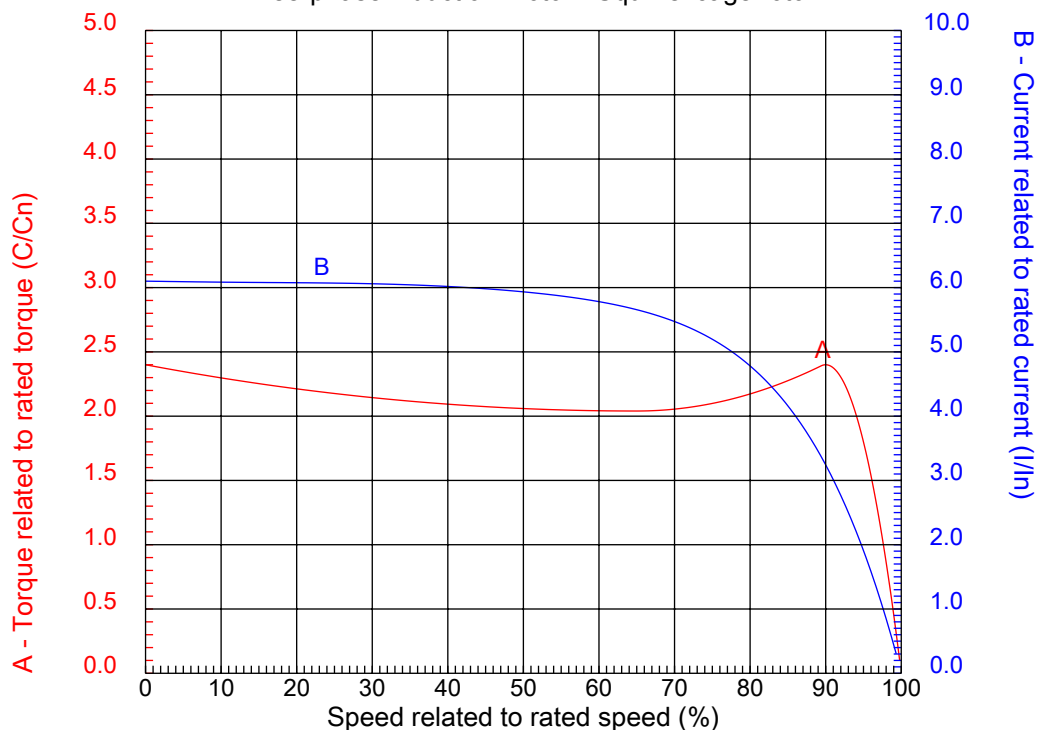

Customer :
Product line : Three-Phase: W22 IEEE-841™ Petrochem Motors - NEMA Premium® Efficiency

Frame	: 286T	Locked rotor current (I _l /I _n)	: 6.1
Output	: 30 HP	Duty cycle	: S1
Frequency	: 60 Hz	Service factor	: 1.25
Full load speed	: 1765	Design	: B
Voltage	: 460 V	Locked rotor torque	: 240 %
Rated current	: 35.1 A	Breakdown torque	: 240 %
Insulation class	: F		

Notes:

Performed by

Checked

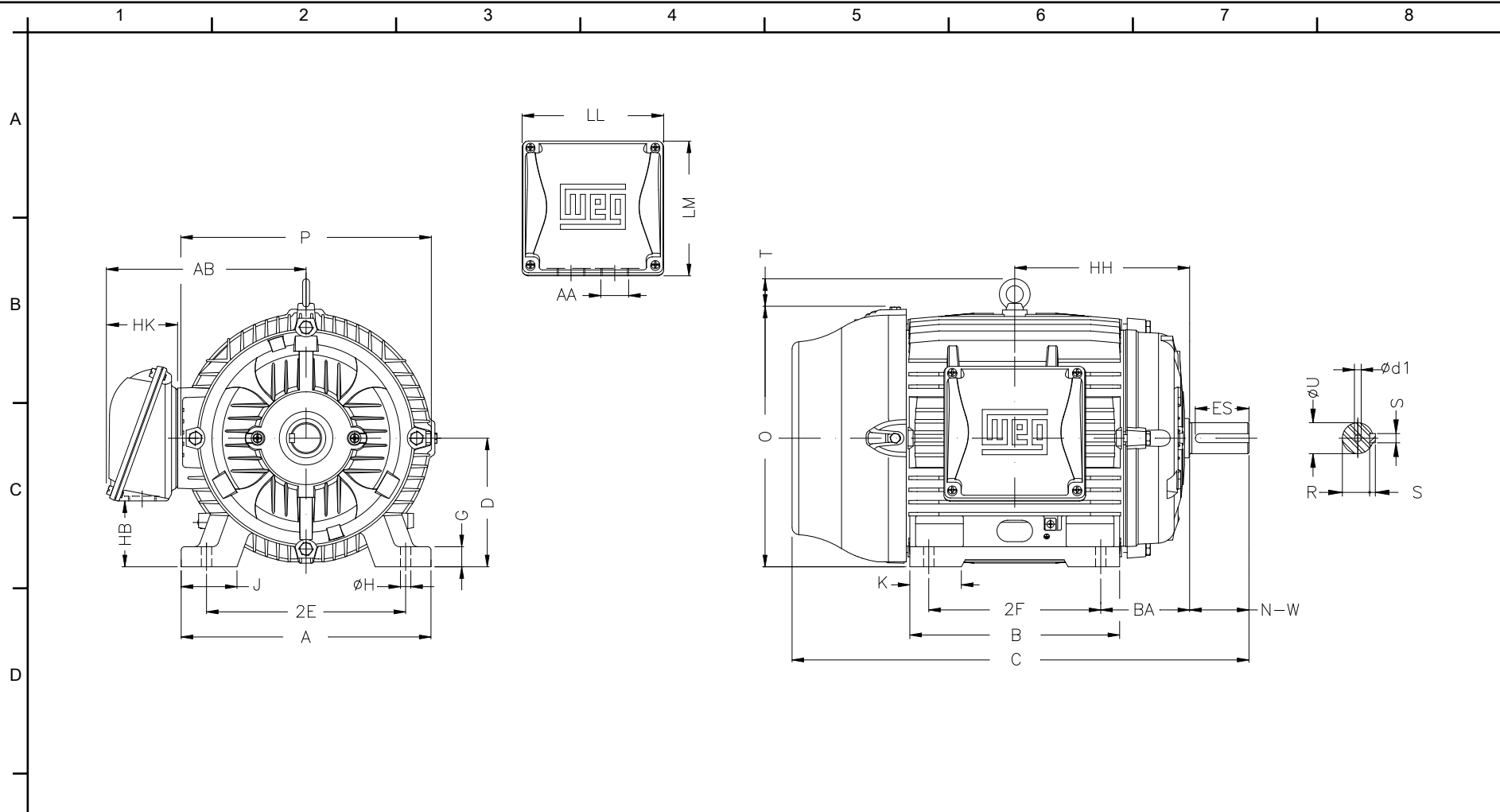

E	2E 11.000	J 3.110	A 13.780	P 14.173	AB 10.984
	2F 11.000	K 2.874	B 13.071	BA 4.750	U 1.875
	N-W 4.622	ES 3.149	S 0.500	R 1.594	depth 0.500
	D 7.000	G 1.023	HB 3.535	O 14.067	T 2.087
	HD 16.154	HF 7.000	HH 10.250	HK 3.937	H 0.531
F	C 27.929	LL 7.795	LM 7.402	AA NPT 1 1/2"	d1 A 4
	d2 A 4	Flange FD-317	AJ 12.500	AK 11.000	BD 14.00
	BF 0.828	BB 0.203			

Notes:

Performed by:

Checked:

Customer:

Three-Phase: W22 IEEE-841™ Petrochem Motors - NEMA Premium® Efficiency

Three-phase induction motor Frame 286T - IP55	27-DEC-2012	
--	-------------	--