



No.:

Date: 28-DEC-2012

Customer :

TECHNICAL PROPOSAL

Three-phase induction motor - Squirrel cage rotor

Product line : Three-Phase : W22 Crusher Duty TEFC (IP55)

Catalog Number : 40018EP3GKD580Z-W22

List Price : \$43,272

Notes:

Performed by:

Checked:



No.:

Date: 28-DEC-2012

DATA SHEET

Three-phase induction motor - Squirrel cage rotor

Customer :
Product line : Three-Phase : W22 Crusher Duty TEFC (IP55)

Frame : 586/7Z
Output : 400 HP
Frequency : 60 Hz
Poles : 4
Full load speed : 1790
Slip : 0.56 %
Voltage : 460 V
Rated current : 452 A
Locked rotor current : 3250 A
Locked rotor current (I_L/I_n) : 7.2
No-load current : 138 A
Full load torque : 1158 lb.ft
Locked rotor torque : 210 %
Breakdown torque : 240 %
Design : A
Insulation class : F
Temperature rise : 80 K
Locked rotor time : 12 s (hot)
Service factor : 1.15
Duty cycle : S1
Ambient temperature : -20°C - +40°C
Altitude : 1000
Degree of Protection : IP55
Approximate weight : 3771 lb
Moment of inertia : 192.69 sq.ft.lb
Noise level : 81 dB(A)

	D.E.	N.D.E.	Load	Power factor	Efficiency (%)
Bearings	NU-324 C3	6319 C3	100%	0.87	95.8
Regreasing interval	3000 h	8000 h	75%	0.84	95.8
Grease amount	72 g	45 g	50%	0.77	95.4

Notes:

Performed by

Checked



No.:

Date: 28-DEC-2012

PERFORMANCE CURVES RELATED TO RATED OUTPUT

Three-phase induction motor - Squirrel cage rotor

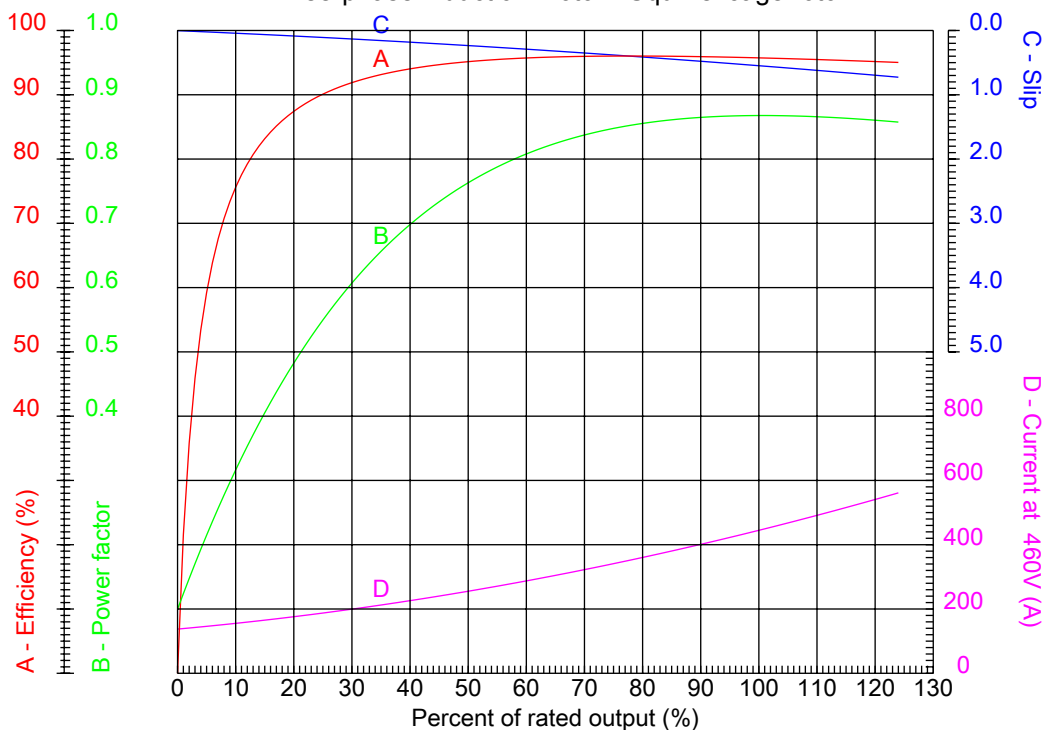

Customer :
Product line : Three-Phase : W22 Crusher Duty TEFC (IP55)

Frame : 586/7Z	Locked rotor current (I _l /I _n) : 7.2
Output : 400 HP	Duty cycle : S1
Frequency : 60 Hz	Service factor : 1.15
Full load speed : 1790	Design : A
Voltage : 460 V	Locked rotor torque : 210 %
Rated current : 452 A	Breakdown torque : 240 %
Insulation class : F	

Notes:

Performed by

Checked



No.:

Date: 28-DEC-2012

CHARACTERISTIC CURVES RELATED TO SPEED

Three-phase induction motor - Squirrel cage rotor

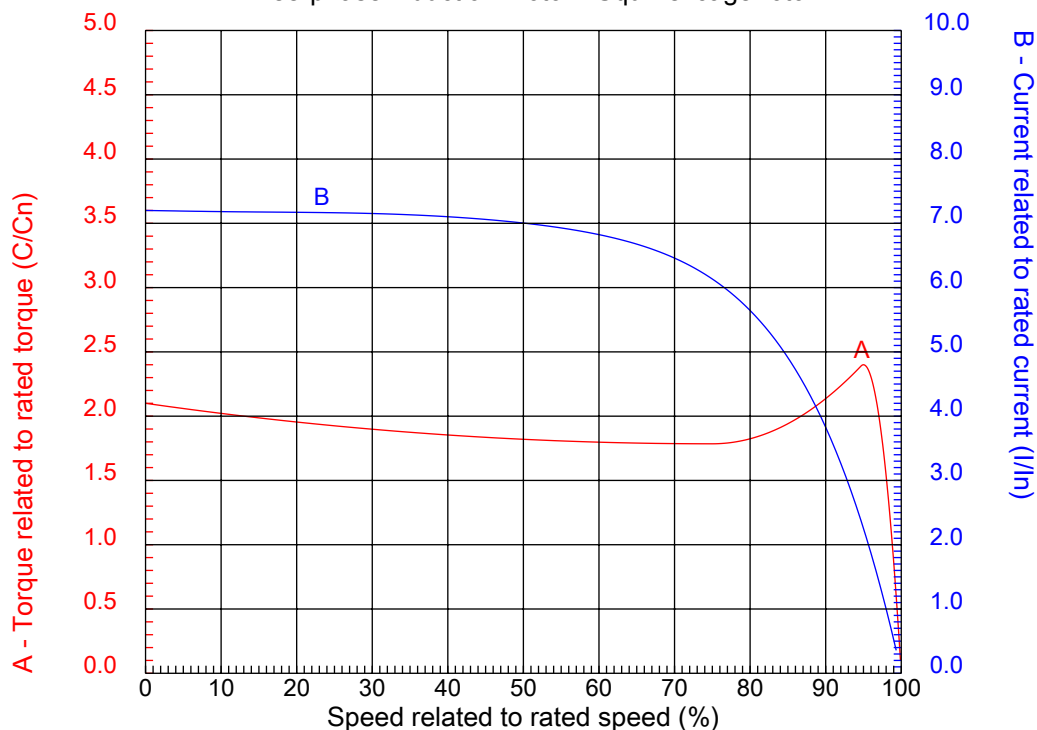

Customer :
Product line : Three-Phase : W22 Crusher Duty TEFC (IP55)

Frame	: 586/7Z	Locked rotor current (I _l /I _n)	: 7.2
Output	: 400 HP	Duty cycle	: S1
Frequency	: 60 Hz	Service factor	: 1.15
Full load speed	: 1790	Design	: A
Voltage	: 460 V	Locked rotor torque	: 210 %
Rated current	: 452 A	Breakdown torque	: 240 %
Insulation class	: F		

Notes:

Performed by

Checked

1 2 3 4 5 6 7 8

A

B

C

D

E

F

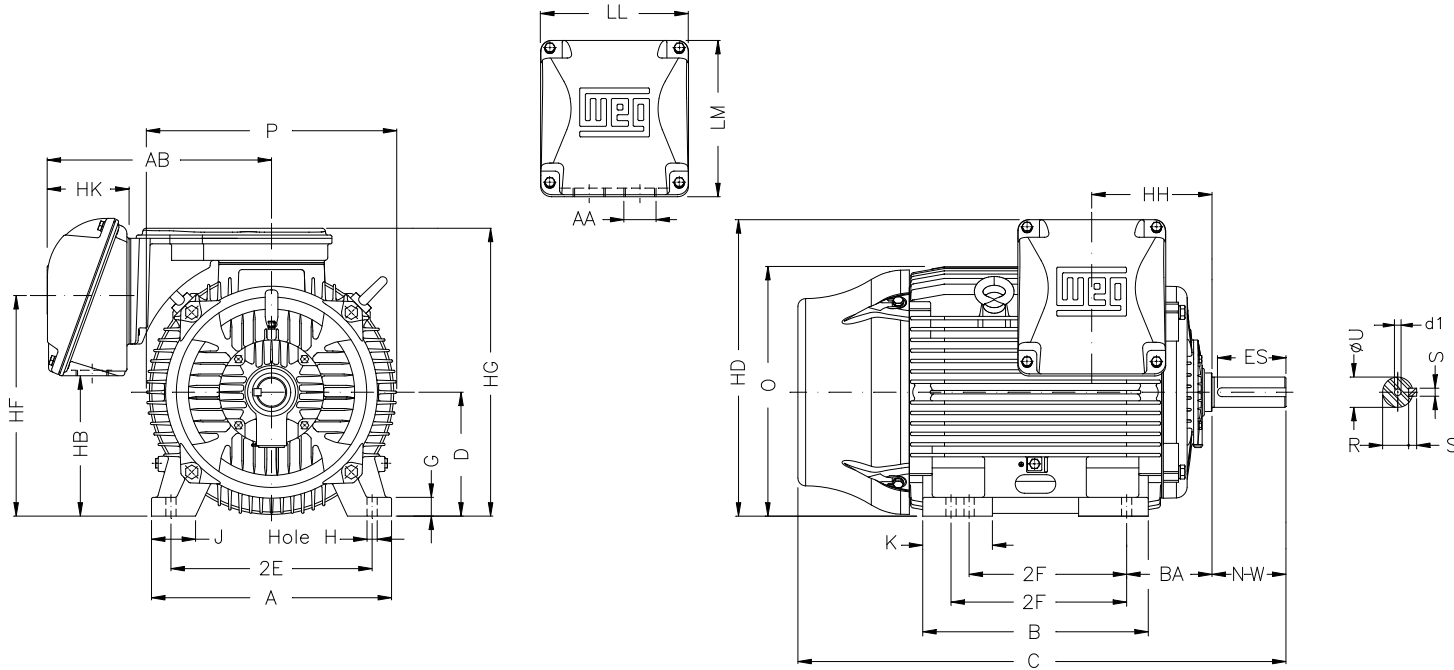

Notes:

2E 23.000	J 5.512	A 29.528	P 28.977	AB 23.977
2F 22.000/25.000	K 9.055	B 29.921	BA 10.000	U 4.375
N-W 11.625	ES 8.661	S 1.000	R 3.816	depth 1.000
D 14.500	G 2.492	HB 17.322	O 28.985	T 5.552
HD 34.537	HF 26.732	HG 33.346	HH 13.386	HK 8.464
H 1.181	C 61.902	LL 15.906	LM 17.244	AA 2XNPT 3"
d1 DUNC 7/8"-9	d2 DUNC 3/4"-10			

Performed by:

Checked:

Customer:

Three-Phase : W22 Crusher Duty TEFC (IP55)

Three-phase induction motor
Frame 586/7Z - IP55

28-DEC-2012

