

Assembly - Step 3:

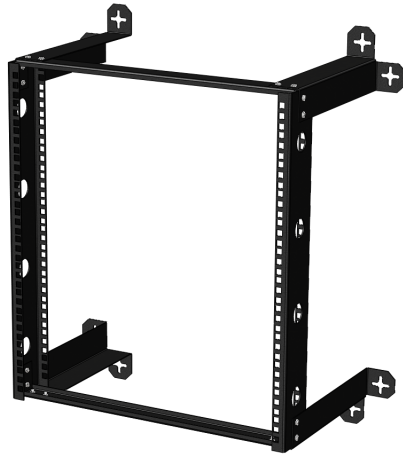

Mount rack to wall using appropriate hardware (not included). Fasten to secure surfaces such as wall studs to increase weight capacity.



For details about product warranty, please visit www.kendallhoward.com

DISCLAIMER: Kendall Howard LLC. endeavors to make this manual accurate and complete. However, Kendall Howard LLC makes no representations or warranties of any kind, expressed or implied, about whether the use of products contained herein would infringe any rights or the correctness, accuracy or reliability of the information contained herein or that said information covers all details, conditions or variations. The information herein does not provide for every possible contingency in connection with the installation or use of the product(s). The information contained in this document is subject to change without notice or obligation. Kendall Howard LLC assumes no responsibility for the accuracy, completeness or reliability of the information contained in this document. Any reliance placed on the information is therefore strictly at your own risk.

Instructions / Directions

V-Line Wall-Mount Rack 21U #1915-3-300-21

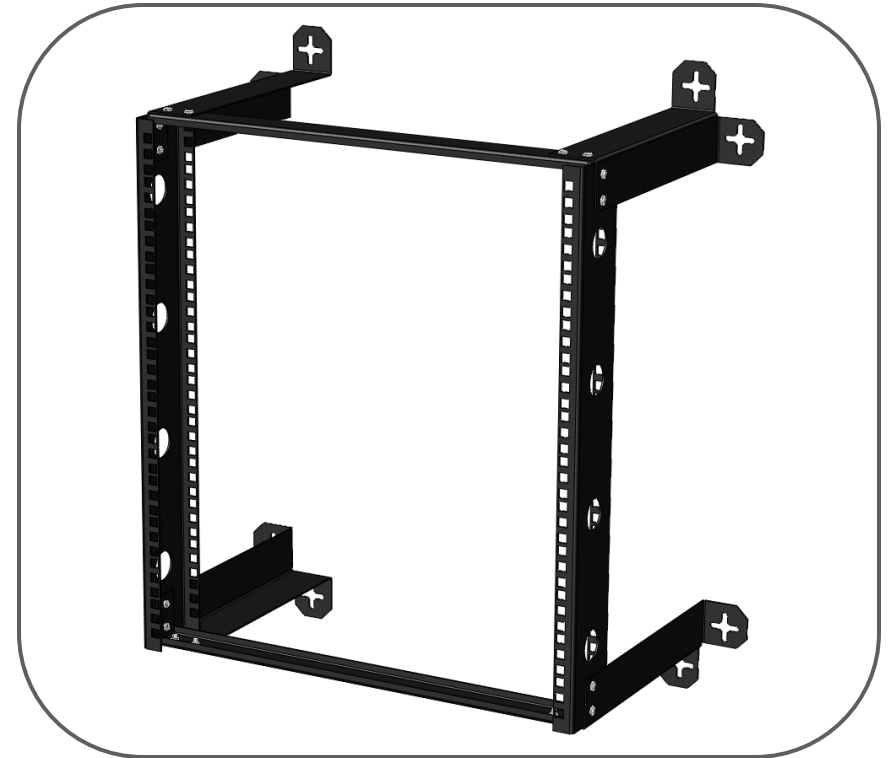

www.kendallhoward.com

KENDALL HOWARD  TM
INNOVATORS IN PRODUCT DESIGN

Address: 10152 Liberty Lane
Chisago City, Minnesota, 55013
United States of America
Phone: 651-213-1333
Fax: 800-418-6897

Tools Needed:

Screw Driver



Assembly - Step 1:



Lay Side Rails face down. Align H-Braces at both ends and Corner Brackets on the outside at each corner.

*Note: Rack comes in several sizes, but assemble and install in the same way.

Included:

(2x) H-Brace



(2x) Side Rail



(4x) Corner Bracket

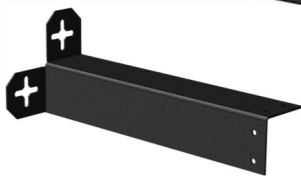

(24x) Rack Screw

(24x) Cage Nut

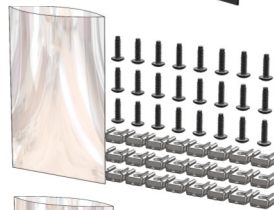

(16x) 10-32 Screw

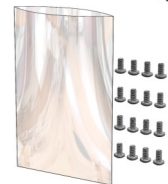

Assembly - Step 2:

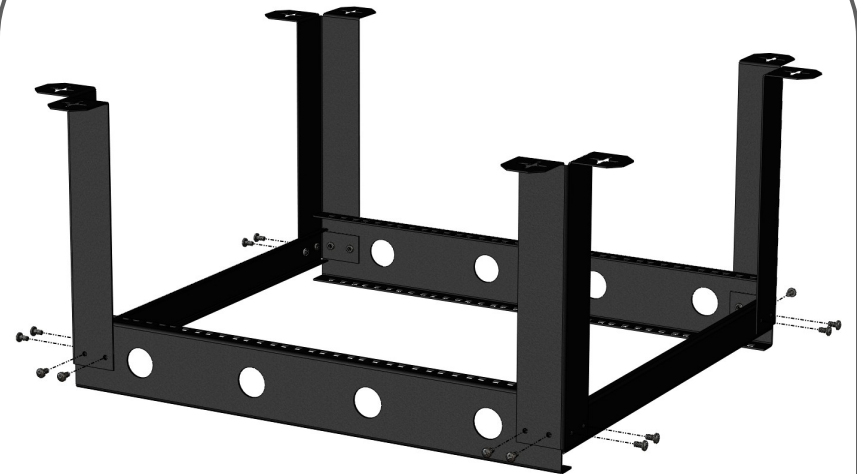

Use the supplied 10-32 Screws to fasten the rack together.
Use a Screw Driver to secure all of the screws.

2

3