



No.:

Date: 17-DEC-2012

Customer :

TECHNICAL PROPOSAL

Three-phase induction motor - Squirrel cage rotor

Product line : W22 NEMA Premium - Ball Bearings

Catalog Number : 65018ET3G588/9-W22

List Price : \$66,701

Notes:

Performed by:

Checked:



No.:

Date: 17-DEC-2012

## DATA SHEET

### Three-phase induction motor - Squirrel cage rotor

Customer :  
Product line : W22 NEMA Premium - Ball Bearings

Frame : 588/9T  
Output : 650 HP  
Frequency : 60 Hz  
Poles : 4  
Full load speed : 1790  
Slip : 0.56 %  
Voltage : 460 V  
Rated current : 734 A  
Locked rotor current : 5430 A  
Locked rotor current (I<sub>L</sub>/I<sub>n</sub>) : 7.4  
No-load current : 280 A  
Full load torque : 1881 lb.ft  
Locked rotor torque : 250 %  
Breakdown torque : 270 %  
Design : B  
Insulation class : F  
Temperature rise : 80 K  
Locked rotor time : 22 s (hot)  
Service factor : 1.00  
Duty cycle : S1  
Ambient temperature : -20°C - +40°C  
Altitude : 1000  
Degree of Protection : IP55  
Approximate weight : 4395 lb  
Moment of inertia : 300.95 sq.ft.lb  
Noise level : 81 dB(A)

	D.E.	N.D.E.	Load	Power factor	Efficiency (%)
Bearings	6322 C3	6319 C3	100%	0.85	96.6
Regreasing interval	6000 h	8000 h	75%	0.81	96.5
Grease amount	60 g	45 g	50%	0.71	96.0

Notes:

Performed by

Checked



No.:

Date: 17-DEC-2012

### PERFORMANCE CURVES RELATED TO RATED OUTPUT Three-phase induction motor - Squirrel cage rotor

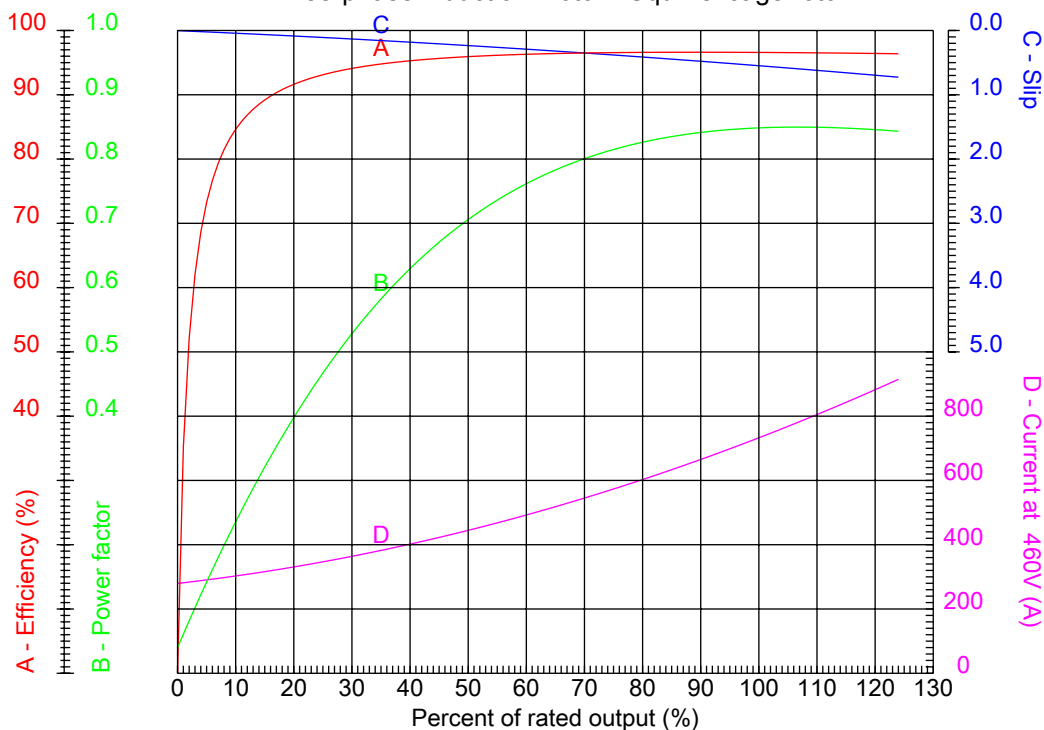

Customer :  
Product line : W22 NEMA Premium - Ball Bearings

Frame : 588/9T	Locked rotor current (I <sub>l</sub> /I <sub>n</sub> ) : 7.4
Output : 650 HP	Duty cycle : S1
Frequency : 60 Hz	Service factor : 1.00
Full load speed : 1790	Design : B
Voltage : 460 V	Locked rotor torque : 250 %
Rated current : 734 A	Breakdown torque : 270 %
Insulation class : F	

Notes:

Performed by

Checked



No.:

Date: 17-DEC-2012

### CHARACTERISTIC CURVES RELATED TO SPEED Three-phase induction motor - Squirrel cage rotor

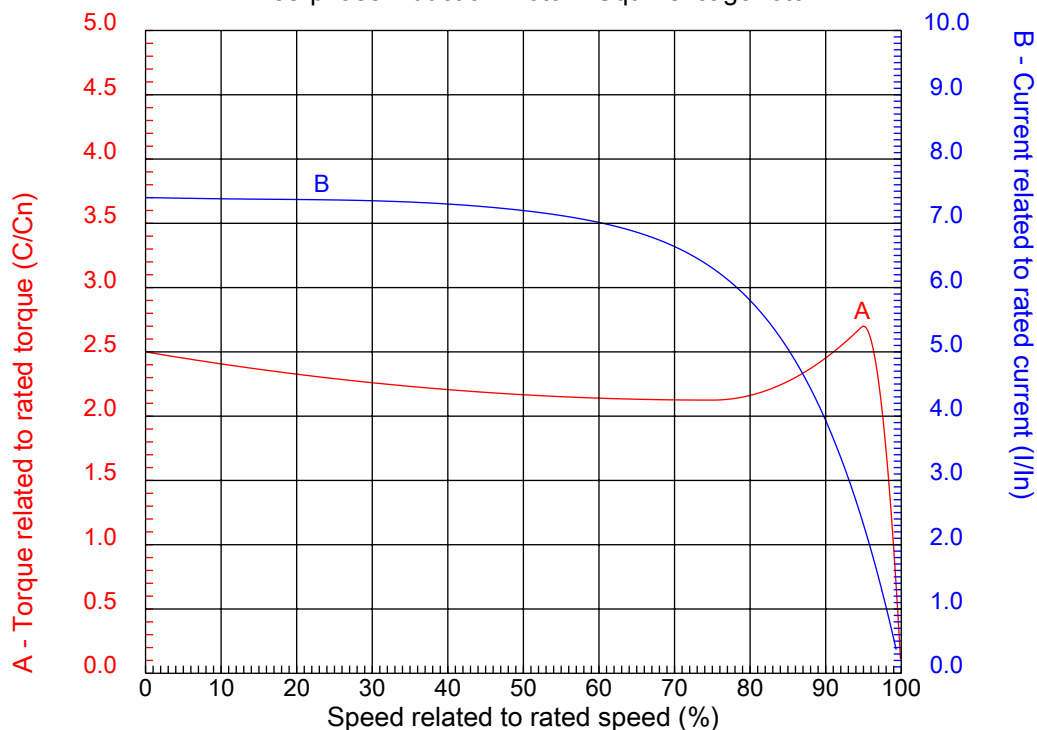

Customer :  
Product line : W22 NEMA Premium - Ball Bearings

Frame	: 588/9T	Locked rotor current (I <sub>l</sub> /I <sub>n</sub> )	: 7.4
Output	: 650 HP	Duty cycle	: S1
Frequency	: 60 Hz	Service factor	: 1.00
Full load speed	: 1790	Design	: B
Voltage	: 460 V	Locked rotor torque	: 250 %
Rated current	: 734 A	Breakdown torque	: 270 %
Insulation class	: F		

Notes:

Performed by

Checked

1 2 3 4 5 6 7 8

A

B

C

D

E

F

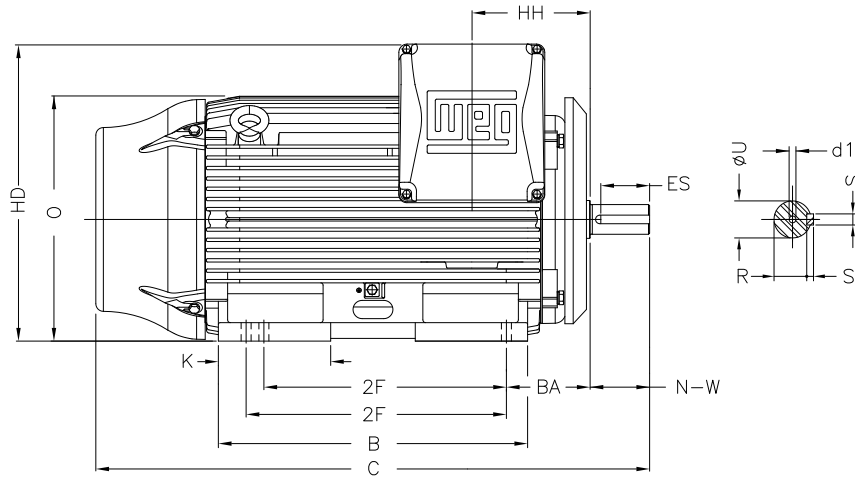
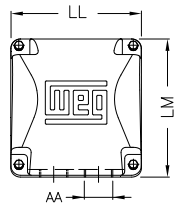
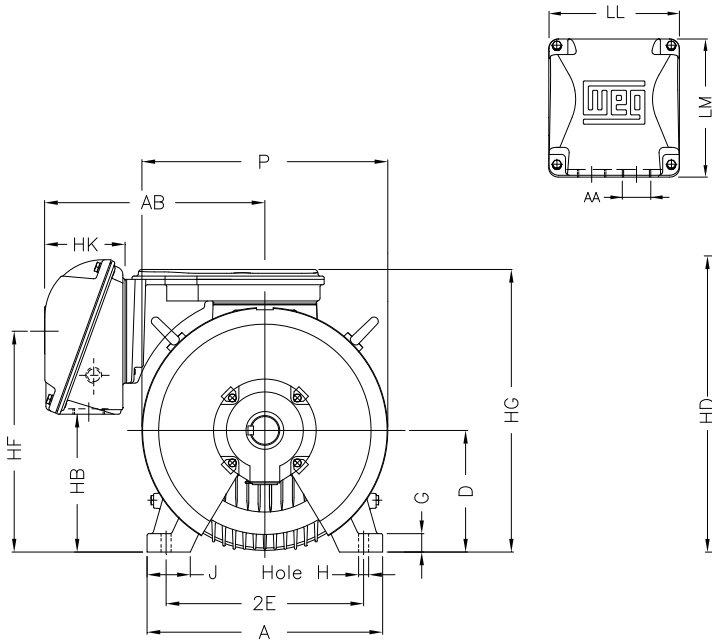

Notes:

Performed by:

Checked:

Customer:

W22 NEMA Premium - Ball Bearings

Three-phase induction motor  
Frame 588/9T - IP55

17-DEC-2012



2E 23.000	J 5.512	A 29.528	P 28.977	AB 27.600
2F 28.000/32.000	K 13.030	B 37.980	BA 10.000	U 3.875
N-W 11.625	ES 8.661	S 1.000	R 3.312	depth 1.000
D 14.500	G 2.492	HB 6.063	O 28.985	T 6.361
HF 26.182	HG 33.346	HH 13.386	HK 11.417	H 1.181
C 69.381	LL 18.110	LM 21.456	AA 2XNPT 4"	d1 DUNC 7/8"-9
d2 DUNC 3/4"-10	Flange FD-762	AJ 30.000	AK 28.000	BD 32.000
BF 0.828	BB 0.250			