

SECTION B-B

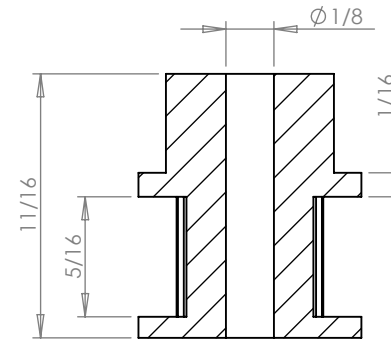
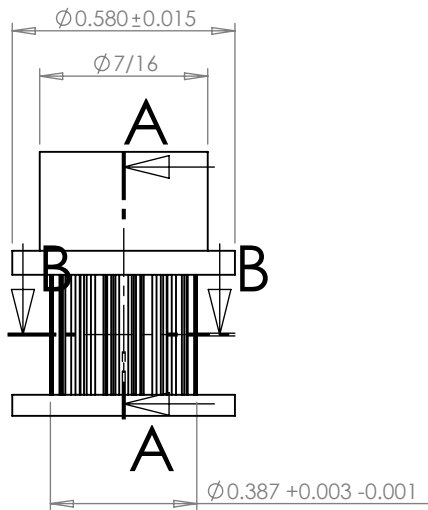
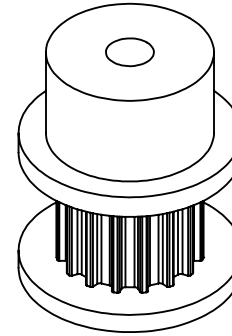

SECTION A-A

PLASTOCK®
Manufactured by Putnam Precision Molding

Part Number:
16T0800DF

www.plastock.biz
© 2010 Putnam Precision Molding

Part Description:
.0800" Pitch (MXL) Timing Belt
Pulleys For Belts up to 1/4" Wide

Dimensions are in inches
Tolerances:
Fractional ± 0.015

PROPRIETARY AND CONFIDENTIAL : THE INFORMATION CONTAINED IN THIS DRAWING IS THE SOLE PROPERTY OF PUTNAM PRECISION MOLDING. ANY REPRODUCTION IN PART OR AS A WHOLE WITHOUT THE WRITTEN PERMISSION OF PUTNAM PRECISION MOLDING IS PROHIBITED. INFORMATION IN THIS DRAWING IS PROVIDED FOR REFERENCE ONLY.