



Drawing	: - TPC 401
Issue	: - 5
Date	: - 28/04/14

**DD700**  
**10551GR-US – 460V / 3PH / 60HZ**  
**INDUSTRIAL DEHUMIDIFIER**  
**OWNER'S MANUAL**

**[www.eipl.co.uk](http://www.eipl.co.uk)**



Drawing	: - TPC 401
Issue	: - 5
Date	: - 28/04/14

## DD700

# PACKAGE CONTENTS

Item	Description	Quantity
10551GR-US	Dehumidifier	1
TPC401	Manual	1

## UNPACKING

Carefully remove the DD700 dehumidifier unit from its transit box and visually check for signs of transit damage. If there is evidence of damage DO NOT attempt to operate the unit, call your supplier for advice. Do not discard the packing, it will be useful when transporting the dehumidifier unit in the future.

## INTRODUCTION

Dehumidifiers remove moisture from the air that is circulating through the unit. The resulting reduction of relative humidity helps prevent rust, rot, mould, mildew and condensation within the room, or other enclosed spaces where the dehumidifier is used.

The DD700 is of the desiccant wheel type designed to dry air by passing a large volume of air, the “process” air through a slowly rotating Silica gel rotor. Silica gel is a hygroscopic material that absorbs moisture direct from the air. As the air passes through the rotor the humidity of the air is reduced, whilst the moisture content of the rotor is increased. A smaller volume of air, the reactivation air, is heated by an internal heater and passes through a portion of the rotor in the opposite direction. As this heated air passes through the rotor it will “reactivate” it by removing the moisture content from the silica gel material. The reactivation air will leave the humidifier as warm, moist air and must be vented to outside of the building.

Continuous circulation of the room air through the dehumidifier unit gradually reduces the relative humidity in the room.

The DD700 dehumidifier is a robust, compact unit designed to control the humidity in the enclosed space in which it is placed. The casing is fabricated from Steel then painted and has been designed for the exacting conditions which can prevail in offices, shops, houses, restaurants, public houses etc. It combines lightness and compactness with high reliability and strength.

The unit is thermally protected and will automatically switch off in excessive or abnormal conditions.

The dehumidifier has two separate filters. One in the “process” air inlet and one in the “reactivation” air inlet, used to clean the air entering the dehumidifier.



Drawing	: - TPC 401
Issue	: - 5
Date	: - 28/04/14

## SPECIFICATIONS

<b>MODEL:</b>	DD700
<b>HEIGHT:</b>	1020mm (40")
<b>WIDTH:</b>	711mm (28")
<b>DEPTH:</b>	584mm (23")
<b>WEIGHT:</b>	85Kg (187.4lbs)
<b>POWER SUPPLY:</b>	460V, 3 ph, 60Hz
<b>POWER</b>	7.5 kW (max)
<b>F1 CONTROLS FUSE</b>	2A 250V 5x20 Cartridge fuse
<b>PROCESS AIRFLOW MAXIMUM:</b>	1500m <sup>3</sup> /hr (883 cfm)
<b>PROCESS AIRFLOW NOMINAL:</b>	700m <sup>3</sup> /hr (412 cfm)
<b>REGENERATION AIRFLOW NOMINAL:</b>	160m <sup>3</sup> /hr (94 cfm)
<b>PROCESS AIR OUTLET DIA:</b>	200mm (8")
<b>REGENERATION AIR OUTLET DIA:</b>	150mm (6")
<b>ROTOR WHEEL SPEED:</b>	13.6
<b>ROTOR SIZE DIA X DEPTH:</b>	350mm (13.8") x 100mm (4")
<b>HIGH EXTRACTION SETTING @ 27°C 60% RH:</b>	109 l/day (231 ppd)
<b>HIGH EFFICIENCY SETTING @ 27°C 60% RH:</b>	87 l/day (184 ppd)
<b>DEEP DRYING SETTING @ 27°C 60% RH:</b>	97 l/day (205 ppd)
<b>TYPICAL DRY AIR OFF HIGH EXTRACTION SETTING (%RH)</b>	18
<b>TYPICAL DRY AIR OFF HIGH EFFICIENCY SETTING (%RH)</b>	18
<b>TYPICAL DRY AIR OFF DEEP DRYING SETTING (%RH)</b>	8
<b>MINIMUM OPERATING TEMPERATURE:</b>	-20°C (-4°F)
<b>MAXIMUM OPERATING TEMPERATURE</b>	40°C (104°F)























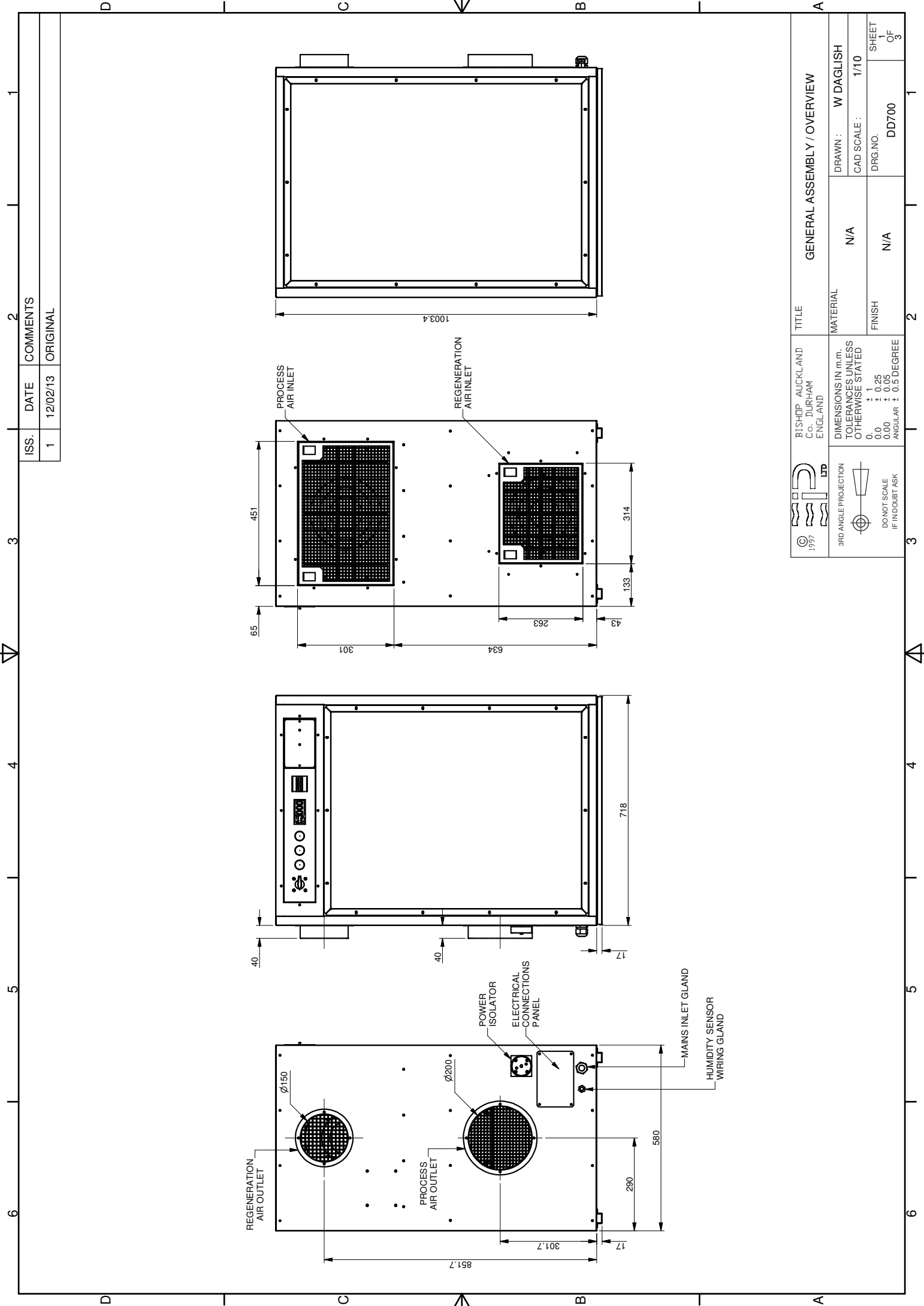

ISS.	DATE	COMMENTS
1	12/02/13	ORIGINAL

GENERAL ASSEMBLY / OVERVIEW	
TITLE	BISHOP AUCKLAND Co. DURHAM ENGLAND
MATERIAL	N/A
FINISH	N/A
DRAWN :	W DAGLISH
CAD SCALE :	1/10
DRG.NO.	DD700
SHEET	OF
3	3

© 1997  
 3RD ANGLE PROJECTION  
 DO NOT SCALE IF IN DOUBT ASK

DIMENSIONS IN m.m. TOLERANCES UNLESS OTHERWISE STATED	
0	+ 1
0.0	+ 0.25
0.00	+ 0.05
ANGULAR	+ 0.5 DEGREE

ISS.	DATE	COMMENTS
1	12/02/13	ORIGINAL

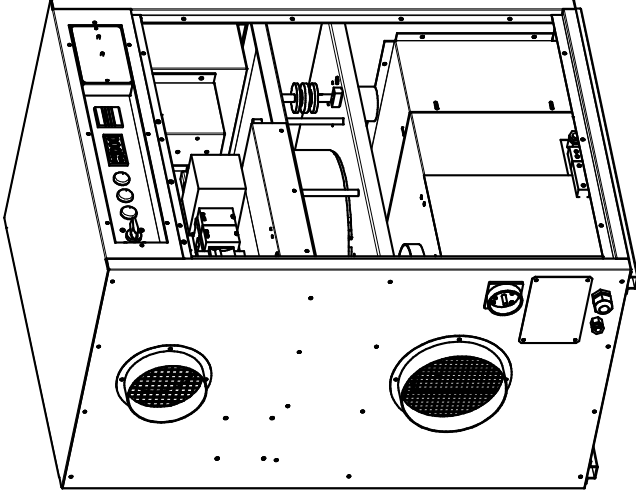
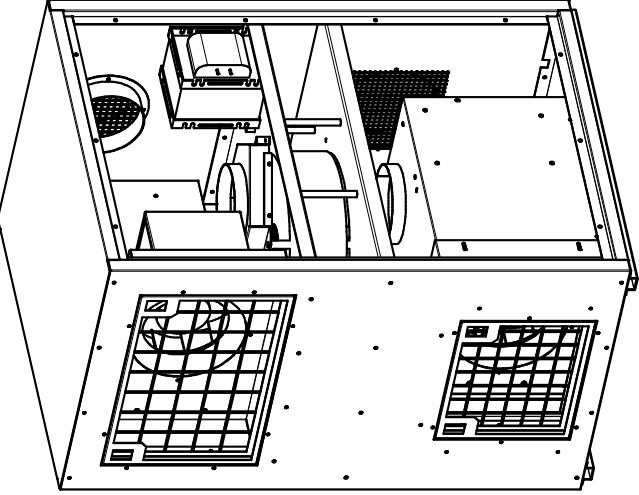
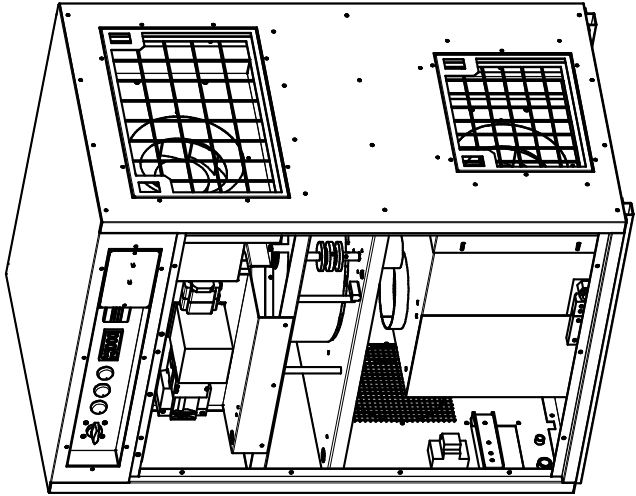
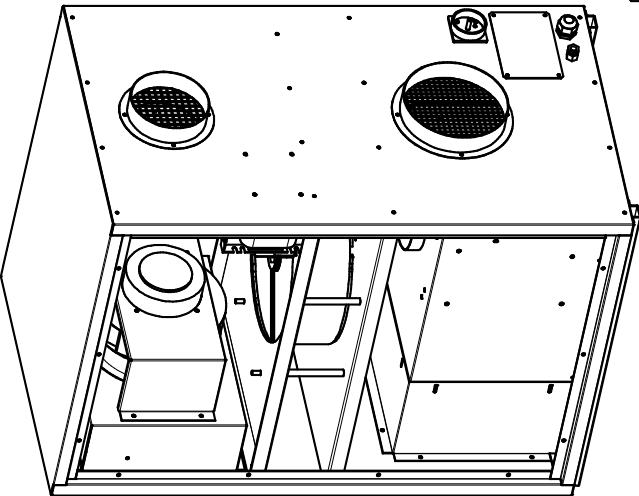
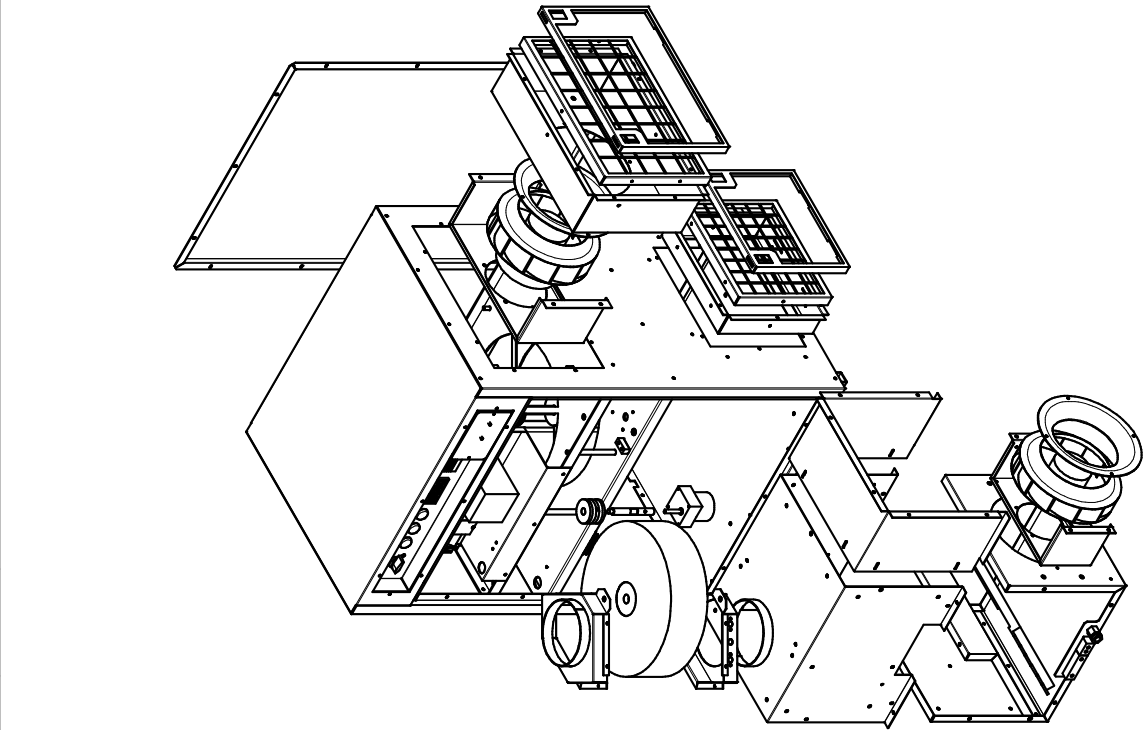

BISHOP AUCKLAND Co. DURHAM ENGLAND		GENERAL ASSEMBLY / OVERVIEW	
DIMENSIONS IN m.m. TOLERANCES UNLESS OTHERWISE STATED		MATERIAL	N/A
0	+ 1	FINISH	N/A
0.0	+ 0.25	DRG.NO.	DD700
0.00	+ 0.05	CAD SCALE:	1/10
ANGULAR	+ 0.5 DEGREE	DRAWN :	W DAGLISH
3RD ANGLE PROJECTION		SHEET	
DO NOT SCALE IF IN DOUBT ASK		1 OF 3	

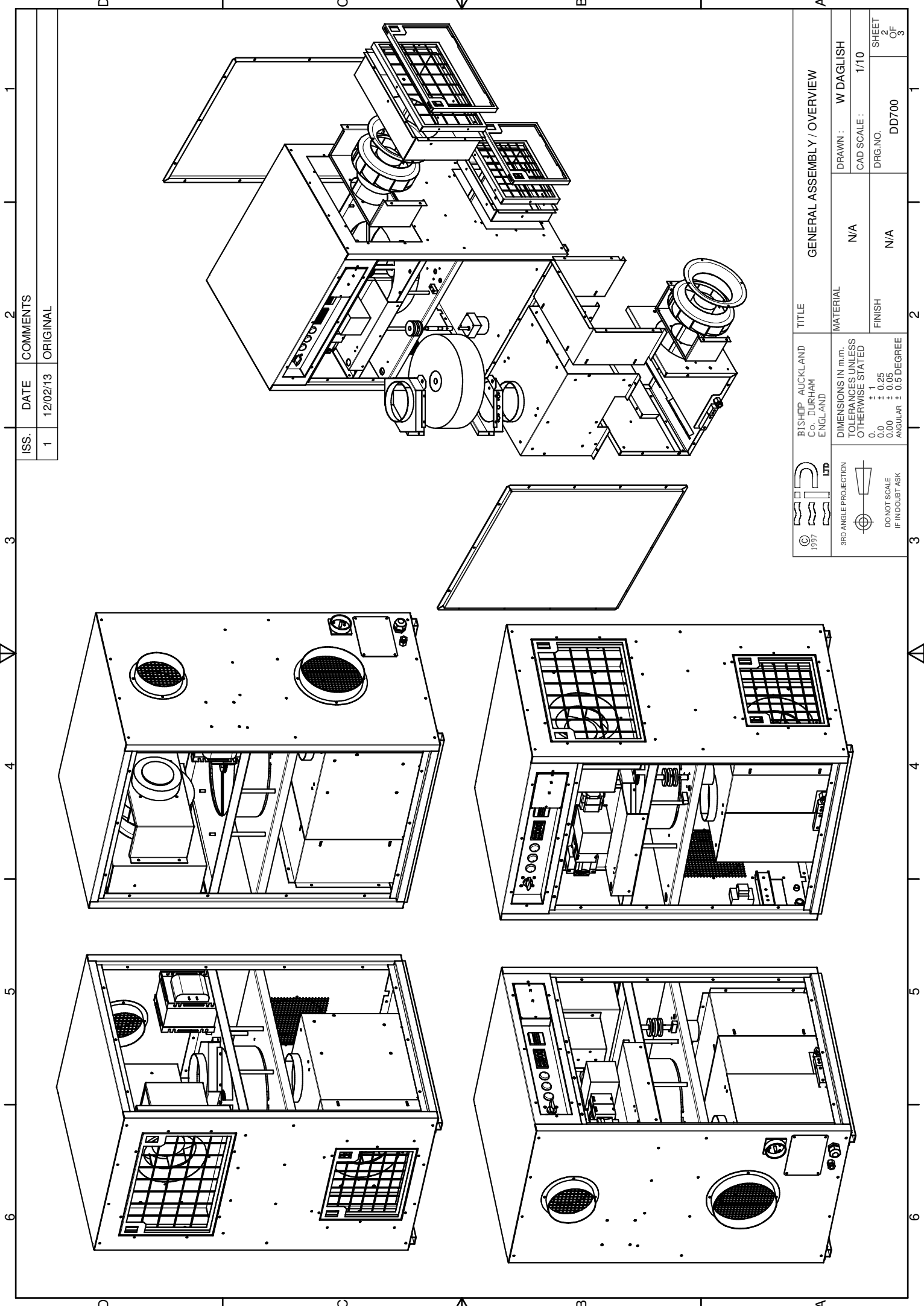



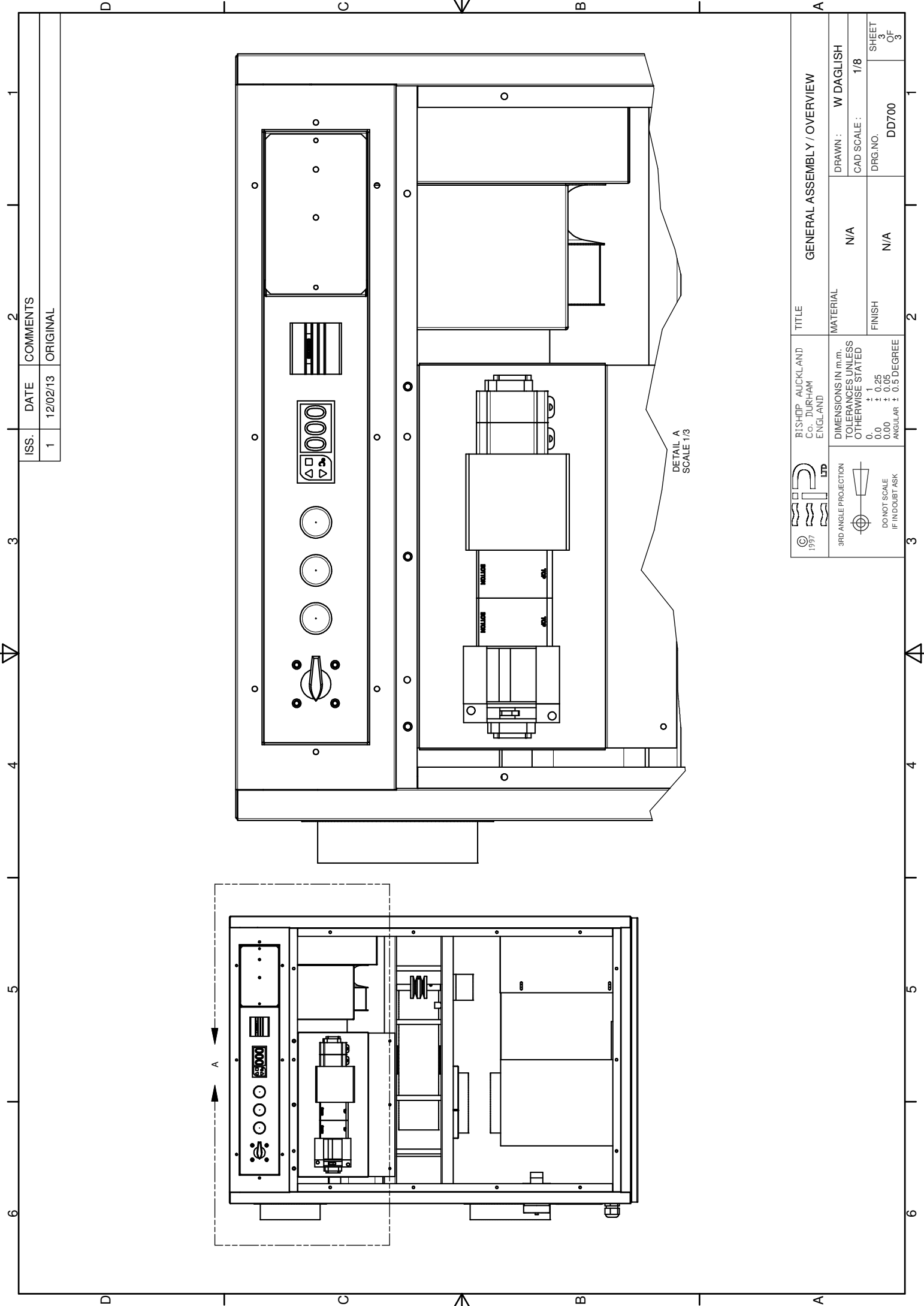

ISS.	DATE	COMMENTS
1	12/02/13	ORIGINAL

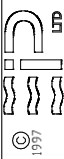
BISHOP AUCKLAND Co. DURHAM ENGLAND		GENERAL ASSEMBLY / OVERVIEW	
 © 1997 3RD ANGLE PROJECTION DO NOT SCALE IF IN DOUBT ASK	DIMENSIONS IN m.m. TOLERANCES UNLESS OTHERWISE STATED	MATERIAL	TITLE
	0 ± 1 0.0 ± 0.25 0.00 ± 0.05 ANGULAR ± 0.5 DEGREE	N/A	N/A
		FINISH	SHEET
		N/A	OF 3



ISSUE	DATE	AMENDMENTS
2	13/02/13	PROTOTYPE ISSUES CORRECTED - WDA
3	13/03/13	PILOT BUILD ISSUES CORRECTED - WDA
4	16/09/13	GENERAL PRODUCTION UPDATE - WDA
5	13/02/14	REGEN OHP ADDED - WDA

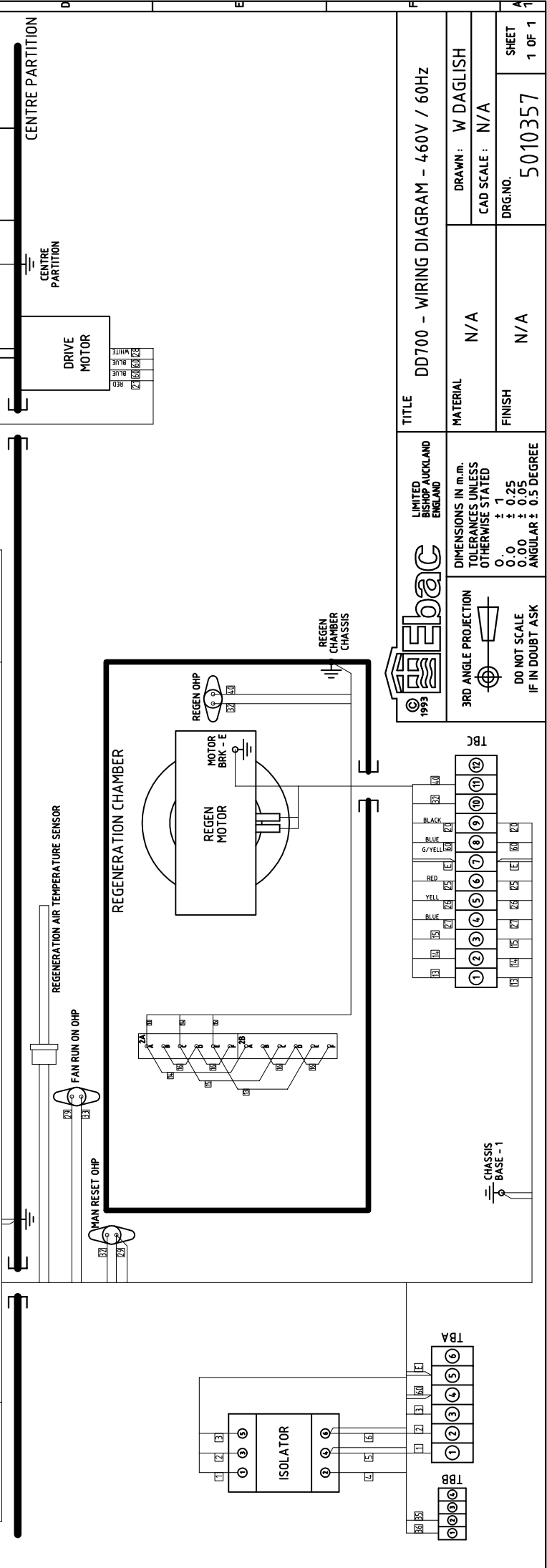
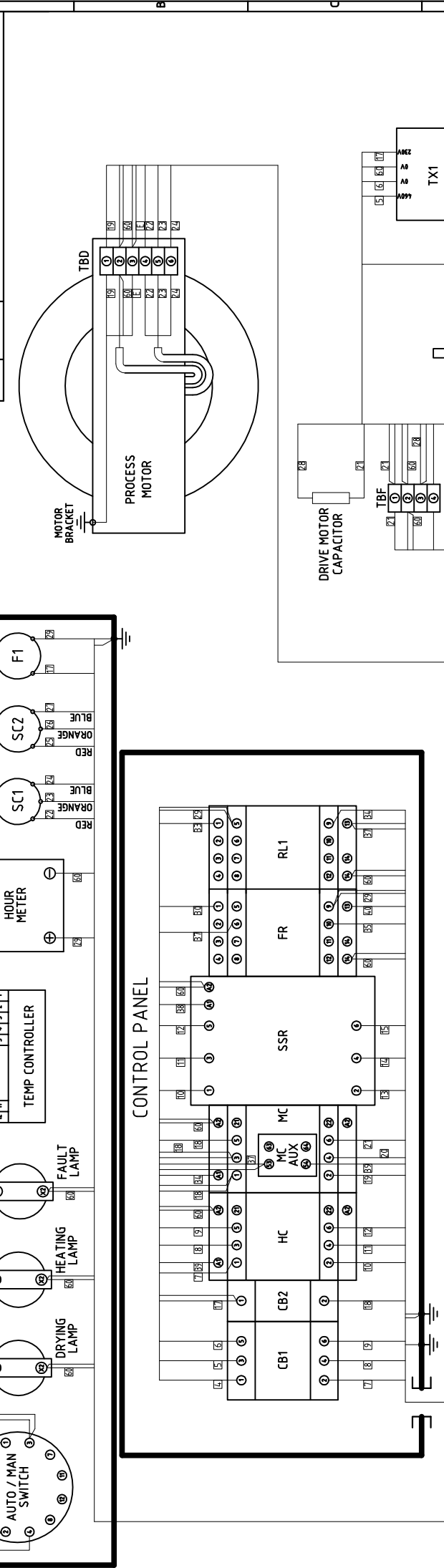
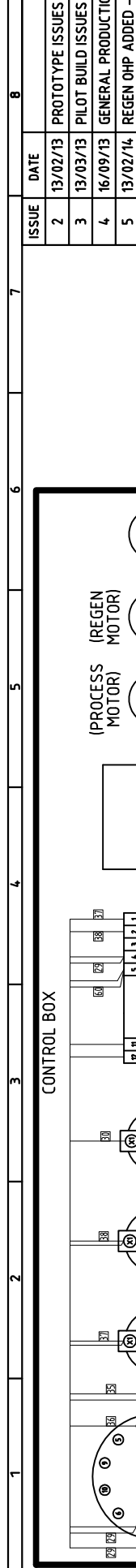

ISSUE	DATE	AMENDMENTS
2	13/02/13	PROTOTYPE ISSUES CORRECTED - WDA
3	13/03/13	PILOT BUILD ISSUES CORRECTED - WDA
4	16/09/13	GENERAL PRODUCTION UPDATE - WDA
5	13/02/14	REGEN OHP ADDED - WDA

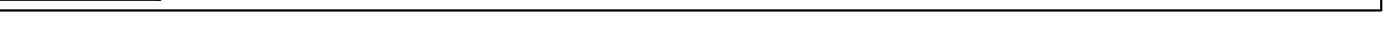

**ebac**  
 1993  
 LIMITED  
 RESURF  
 AUCLAND  
 ENGLAND

3RD ANGLE PROJECTION

DO NOT SCALE  
 IF IN DOUBT ASK

DIMENSIONS IN m.m.  
 TOLERANCES UNLESS  
 OTHERWISE STATED

0.0 ± 0.25  
 0.00 ± 0.05  
 ANGULAR ± 0.5 DEGREE

TITLE	MATERIAL	FINISH
DD700 - WIRING DIAGRAM - 460V / 60Hz	N/A	N/A
DRAWN: W DAGLISH	CAD SCALE: N/A	DRG.NO. 5010357
		SHEET 1 OF 1

