



Outperform every day.™

Project:

Item Number:

Quantity:

## HEATED DISPLAY CABINETS



Drop-in Cabinet



Curved Cabinet



Front Access Curved Cabinet



Cubed Cabinet

Heated Display Cabinets

### DESCRIPTION

Vollrath's heated drop-in and countertop display cabinets enhance the presentation of hot food items. Drop-in models have sliding rear doors for easy access for selling, refilling, changing displays and end-of-day cleaning. Countertop cabinets are available with front and rear access or rear access only.

**WARRANTY:** All models shown come with Vollrath's standard warranty against defects in materials and workmanship. For full warranty details, please refer to the Vollrath Equipment and Smallwares Catalog.

### Agency Listings



Due to continued product improvement, please consult [www.vollrath.com](http://www.vollrath.com) for current product specifications.

### MODELS

- 40845 HDE7136 36" Drop-in Display Cabinet
- 40846 HDE7148 48" Drop-in Display Cabinet
- 40847 HDE7160 60" Drop-in Display Cabinet
- 40855 HDE8136 36" Curved Cabinet
- 40883 HDE8336 36" Curved Cabinet with Front Access
- 40856 HDE8148 48" Curved Cabinet
- 40884 HDE8348 48" Curved Cabinet with Front Access
- 40857 HDE8160 60" Curved Cabinet
- 40885 HDE8360 60" Curved Cabinet with Front Access
- 40865 HDE8236 36" Cubed Cabinet
- 40890 HDE8436 36" Cubed Cabinet with Front Access
- 40866 HDE8248 48" Cubed Cabinet
- 40891 HDE8448 48" Cubed Cabinet with Front Access
- 40867 HDE8260 60" Cubed Cabinet
- 40892 HDE8460 60" Cubed Cabinet with Front Access

### FEATURES

- Inside lighting strips located both at the top of the cabinet and underneath the upper shelf create optimum food display throughout cabinet
- Dual fans circulate air throughout unit to ensure even temperature control
- Triple-glazed front glass gives added strength and insulation
- Drop-in and curved cabinets have two shelves. The cubed cabinet has 3 shelves
- Lift-and-remove rear sliding doors for easy display changes and end of day cleaning
- Digitally controlled thermostat for precise and consistent settings
- 104° - 158° F (40° to 70° C) temperature range
- Drop-in models can also be used as freestanding countertop units
- 6 ft. (1.8 m) 120v cord and plug
- **Note: these items must ship by truck**

### CLEARANCE REQUIREMENTS

- Drop-in cabinets require a minimum of 6" (15.2 cm) of non-combustible countertop to support the unit and a minimum of 6" (15.2 cm) clearance on all sides of the drop-in for proper air circulation.
- Countertop cabinets require a minimum of 6" (15.2 cm) between the equipment and any surrounding walls. Surrounding walls must be made of non-combustible materials.

Approvals	Date



Outperform every day.™  
[www.vollrath.com](http://www.vollrath.com)

The Vollrath Company, L.L.C.  
1236 North 18th Street  
Sheboygan, WI 53081-3201 U.S.A.  
Customer Service: 800.628.0830  
Canada Customer Service: 800.695.8560  
Main Fax: 800.752.5620 or 920.459.6573

Technical Services: 800.628.0832  
Technical Services Fax: 920.459.5462

# HEATED DISPLAY CABINETS

## Drop-in Models

- 40845 HDE7136 36" Drop-in
- 40846 HDE7148 48" Drop-in
- 40847 HDE7160 60" Drop-in

## Curved Models

- 40855 HDE8136 36" Curved
- 40883 HDE8336 36" Curved w/ Front Access
- 40856 HDE8148 48" Curved
- 40884 HDE8348 48" Curved w/ Front Access
- 40857 HDE8160 60" Curved
- 40885 HDE8360 60" Curved w/ Front Access

## Cubed Models

- 40865 HDE8236 36" Cubed
- 40890 HDE8436 36" Cubed w/ Front Access
- 40866 HDE8248 48" Cubed
- 40891 HDE8448 48" Cubed w/ Front Access
- 40867 HDE8260 60" Cubed
- 40892 HDE8460 60" Cubed w/ Front Access

## DIMENSIONS (Shown in inches (cm))

### Drop-in Display Cabinets

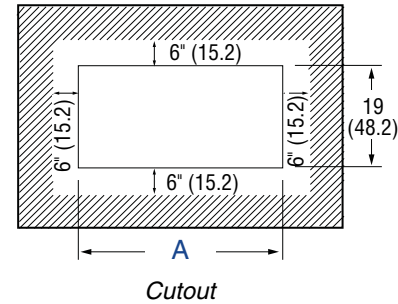
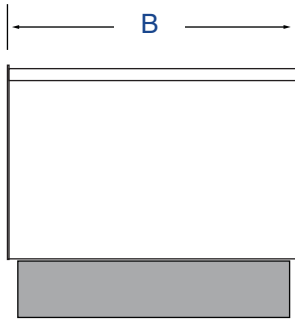
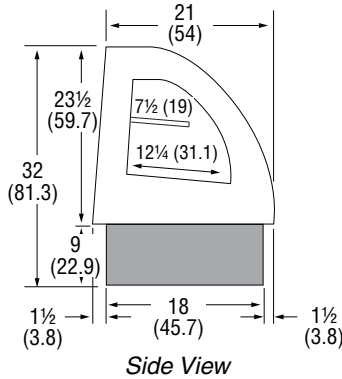

### Curved Display Cabinets

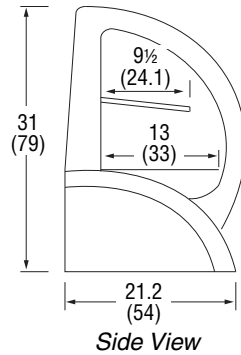
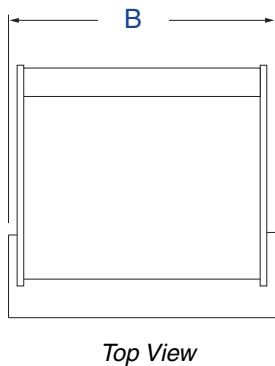

### Cubed Display Cabinets

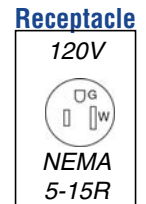
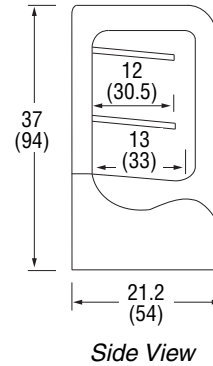
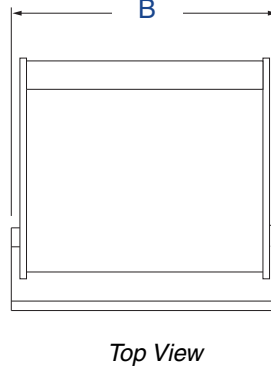

## SPECIFICATIONS

Item	(A) Cutout Width	(B) Width	Watts	Volts	Amps	Weight lb (kg)	NEMA Plug	Item	(B) Width	Watts	Volts	Amps	Weight lb (kg)	NEMA Plug
40845	34 (86.3)	36 (91.4)	670	120	5.6	191 (86.6)	5-15P	40885	59 (149.9)	750	120	6.3	263 (119.2)	5-15P
40846	45 (114.3)	48 (121.9)	710	120	5.9	232 (105.2)	5-15P	40865	35 <sup>7</sup> / <sub>16</sub> (90)	730	120	6.1	220 (99.8)	5-15P
40847	58 (147.3)	60 (152)	750	120	6.3	269 (122)	5-15P	40890	35 <sup>7</sup> / <sub>16</sub> (90)	730	120	6.1	220 (99.8)	5-15P
40855	-	35 <sup>7</sup> / <sub>16</sub> (90)	670	120	5.6	183 (83)	5-15P	40866	47 <sup>3</sup> / <sub>16</sub> (119.9)	790	120	6.6	270 (122.5)	5-15P
40883	-	35 <sup>7</sup> / <sub>16</sub> (90)	670	120	5.6	183 (83)	5-15P	40891	47 <sup>3</sup> / <sub>16</sub> (119.9)	790	120	6.6	270 (122.5)	5-15P
40856	-	47 <sup>3</sup> / <sub>16</sub> (119.9)	710	120	5.9	221 (100.2)	5-15P	40867	59 (149.9)	850	120	7.1	316 (143.3)	5-15P
40884	-	47 <sup>3</sup> / <sub>16</sub> (119.9)	710	120	5.9	221 (100.2)	5-15P	40892	59 (149.9)	850	120	7.1	316 (143.3)	5-15P
40857	-	59 (149.9)	750	120	6.3	263 (119.2)	5-15P							



Outperform every day.™

www.vollrath.com

The Vollrath Company, L.L.C.  
 1236 North 18th Street  
 Sheboygan, WI 53081-3201 U.S.A.  
 Customer Service: 800.628.0830  
 Canada Customer Service: 800.695.8560  
 Main Fax: 800.752.5620 or 920.459.6573

Technical Services: 800.628.0832  
 Technical Services Fax: 920.459.5462