

REFRIGERATOR MANUFACTURER  
**Turbo air**

*Turbo Air Speeds up the Pace of Innovation*

# Display Cases Diamond Show Cases Installation and Operation Manual

Please read this manual completely before attempting to install or operate this equipment!

## REFRIGERATED CASES

CRT-77-1R

CRT-77-2R



## CONTENTS

	PAGE
SPECIFICATIONS .....	2
GENERAL .....	3
STRUCTURE AND PARTS .....	3
HANDLE WITH CARE .....	4
PREPARATION AND POWER SUPPLY .....	5
USE AND CAUTION .....	6
MAINTENANCE .....	7
TROUBLESHOOTING .....	7
PRINCIPLE OF REFRIGERATION SYSTEM .....	8
ELECTRIC CIRCUIT DIAGRAM .....	8
MAJOR PARAMETERS .....	9
WARRANTY .....	10-12

## SPECIFICATIONS

MODEL	COMP H.P	V/Hz	REFRIGERANT	AMPS	WEIGHT
CRT-77-1R	2/9	115V/60Hz	R-134A	6.5	89
CRT-77-2R	2/9	115V/60Hz	R-134A	6.5	90

## SERIAL NUMBER

The serial number is located on the data label inside.  
Please retain the unit's serial number for service purpose.

## GENERAL

1. Beautiful 4 sided glass cabinet allows visibility from all sides to optimize display effect.
2. Safety shielded 4 LED lighting system on every corner of the cabinet ensures a longer life and brighter lighting than fluorescent light bulbs, providing attractive, enhanced and shadow-free illumination.
3. Compact size and counter top design occupies minimum space but maximize impulse sales.
4. It's great space efficiency is ideal for narrow space restaurants and convenience store
5. Elegant contemporary Euro design will enhance the interior and space decoration of any store.

## STRUCTURE & PARTS

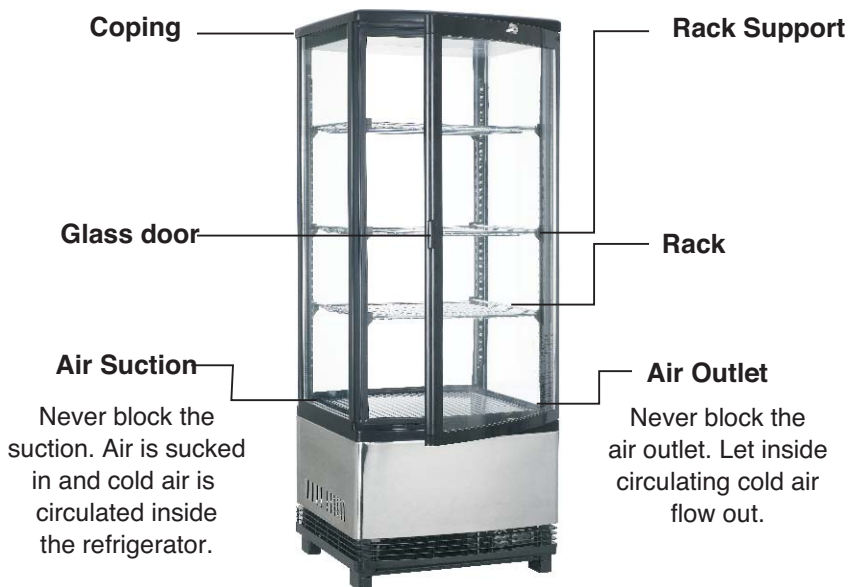

CRT-77-1R and CRT-77-2R are same only except the door.  
CRT-77-1R has one glass door but CRT-77-2R has two.

## HANDLE WITH CARE

### Handle with care

Unplug the wall socket first.  
Never tilt it over 45 degree during handling.

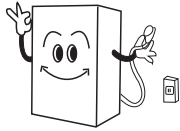

### Dry place

Always locate the refrigerator at a dry place.



### Sufficient space

Keep the rear unit no less than 10cm(4inch)  
from wall or other substance which will  
stop the air flow.

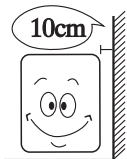

### Well environment

Always locate the refrigerator at a place with  
Ambient Temperature 16-32°C / 60.8-89.6°F.  
The refrigerator might doesn't work properly  
if higher or lower this temperature range.  
For the first time use, wait for 2 hours after  
handling and then plug the wall socket and  
start it.

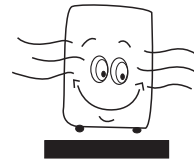

### Far from heat source

Never place the refrigerator directly under  
the sunshine. Never locate it nearby any  
heat source or heater to prevent it from  
reducing refrigeration capability.

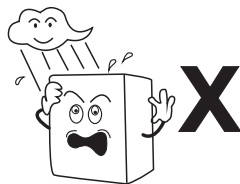

### No heavy load

Never put any heavy load on the top of  
the refrigerator.

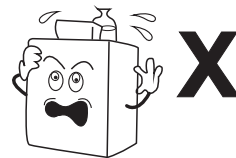

### No hole making

Never make hole on the refrigerator. Never  
install other matter on the refrigerator.

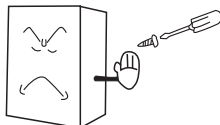

### Stable location

Unpacking and locate the refrigerator on  
a flat and solid place.



## PREPARATION & POWER SUPPLY

### Exclusive power socket

Normally, the power supply should be 110/60Hz single phase AC with exclusive single phase three pin receptacle. (125V, 10-15A)



power receptacle

### No share on socket

Never let the refrigerator share the common socket with other appliance, otherwise the cable becomes hot and fire might be resulted.

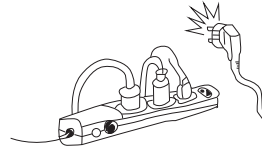

### Protect cables

Never break or damage the cables otherwise current leakage and fire might be resulted.

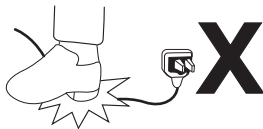

### No water flushing

Never give the refrigerator surface a flush otherwise current leakage might be resulted.



### Prevent from flammables and explosive

Never put any flammable or explosive inside the refrigerator such as ether, gasoline, alcohol, adhesive and explosive. Never put dangerous product nearby the refrigerator.

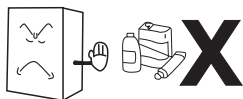

### No spray

To spray the flammables such as paint or coating nearby the refrigerator is not allowed, otherwise fire might be resulted.

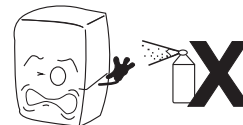

### After power break

If unplug or other power off, please wait at least 5 minutes and then to plug and start it again.

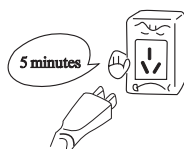

### No medicine

Never put medicine into refrigerator.



## USE & CAUTION

### 1. How to start

Plug the refrigerator on 115V exclusive socket.

After the refrigerator running, put hand on the air suction to confirm it is sufficient cold. Then put th the cold box.

### 2. Regulate temperature

Normally put the controller at “MID” step. The evaporator might be frosted if the controller is at the “FREEZE” step and the refrigerator capability might be decreased. The range of the controller is shoen, which is divided into step of “ LOW, MID, HIGH AND FREEZE”.

The temperature inside the refrigerator would go down if you turn the knob clockwise, while the temperature would go up if you turn it anti-clockwise. It's a referenced temperature only. The temperature was also influenced by the ambient temperature.

Step	Cabinet Temperature
Low	6-12°C/42.8-53.6°F
Mid	5-11°C/41-51.8°F
High	4-10°C/39.2-50°F
Freeze	3-9°C/37.4-48.2°F

### 3. Rack

The rack is adjustable. Please do as follows when you want to adjust the rack.

- Take out the rack.
- Move the rack support on suitable height.
- Put the rack on the support.
- To get a even temperature between top and bottom please adjust the equal height between each rack.

### 4. Cautions

Shorten the door opening time and reduced opening frequency are good to keep a inside cold temperature of refrigerator.

Never block the air suction and outlet. Keep air circulation and refrigeration capability. Do not make food fully because it will influence the cooling effect.

Adjust the height of rack for proper food storage.

Make sure the food temperature is down to room temperature before putting hot food into the refrigerator. Indoor usage only never install this outdoor. It should prohibit getting wet from the rain. Only profession personnel is allowed to repair the damaged power cable by special tools.

Never touch compressor to avoid scald.

This equipment is intended for the storage and display such as non-potentially-hazardous bottle, can, securely bagged products and securely wrapped in sealed container only.

## MAINTENANCE

### 1. Notice

Often keep the refrigerator clean and periodical maintenance is necessary.  
Always unplug the socket before maintenance.  
Never use damaged plug or loose socket to prevent electric shock or short circuit.  
Never flush the refrigerator. Never use alkali detergent, soap, gasoline, acetone or brush.

### 2. Clean exterior

Dip soft cloth in neutral detergent (Tableware detergent) to clean the exterior of refrigerator, then wipe it with dry soft cloth.

### 3. Clean interior

Take rack out for cleaning with water.  
Use soft cloth to wipe the box.

### 4. Shut down refrigerator for a long time

Take out all food and unplug the wall socket.  
Clean interior and exterior of the refrigerator thoroughly and open the door for sufficient dry. The glass would be broken easily. Keep the glass far from child.

## TROUBLESHOOTING

Trouble	Cause and Remedy
No Refrigeration	Is the plug in socket well? Does the fuse work? Is there no power?
Unsatisfactory Refrigeration	Is it under the sunshine? Is there any heat source nearby? Is the surrounding ventilation bad? Does the door close well? Does door open for a long time? Is the door seal strip deformed or damaged? Is food congested or too much? Does food block the air suction or outlet Regulate the temperature controller.
Much Noise	The refrigerator does not level. The refrigerator contacts against the wall or other object. There is loose part in refrigerator.
Contact local service agent for help if simple trouble shooting does not solve the problems.	

## NOTE

Following phenomena are not troubles.

The murmur of water is heard when the refrigerator is working. It is a normal phenomenon that the coolant is circulating in the system.

In wet season, condensation might be found on the outside of the refrigerator. It is not a trouble, which is caused by high humidity. Simply use cloth to wipe it.

## PRINCIPLE OF REFRIGERATION SYSTEM

The principle of compression refrigeration consists of “Compression”, “Condensation”, “Throttling” and “Vaporization”. The compression is undertaken by compressor, the condensation is completed by condenser, the throttling valve is executed by capillary and the vaporization is implemented by evaporator. When the coolant is circulating in the closed refrigeration system, the compressor sucks coolant, which has absorbs heat in evaporator, the coolant becomes a high pressure and high temperature gas. In consider, it dissipates heat in air, while the coolant is reliquaries and throttled in capillary and then enters into evaporator with low pressure. The liquefied coolant quickly boils and vaporizes into gas when the pressure suddenly drops. Meanwhile, it absorbs heat inside the refrigerator. And the compressor sucks the low pressure and low temperature gaseous coolant. It is circulating in this way up to realization of intended refrigeration.

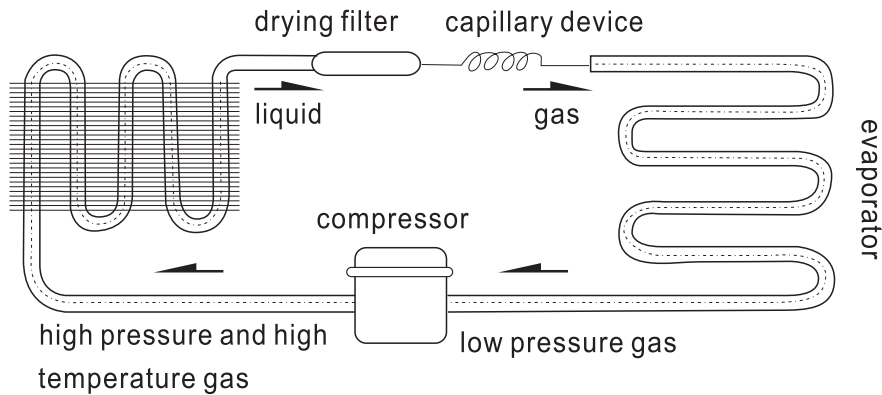

## CIRCUIT DIAGRAM

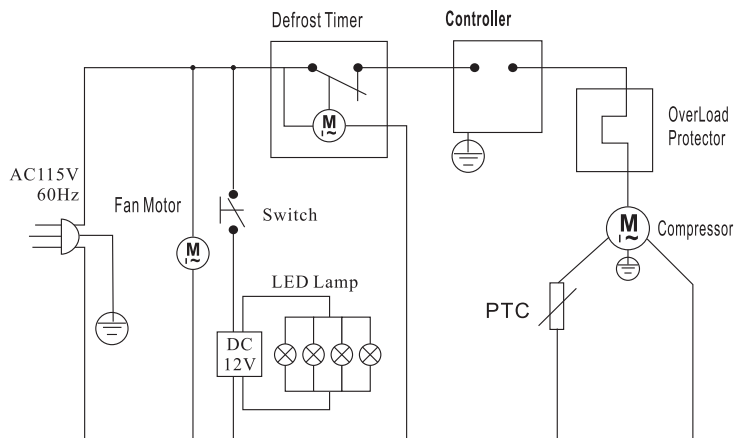



## MAJOR PARAMETERS

Parameter	Model	CRT-77-1R	CRT-77-2R
Coolant and injection quantity		R134a (2.927 Ounce)	R134a (2.927 Ounce)
Rated Input Power (W):		165	165
Type of climate		N	N
Refrigeration temperature		0~12°C/32~53.6 °F	0~12°C/32~53.6 °F
Electric shock protection class		I	I
Power consumption(KW.H/24H)		2	2
High-side design pressures		3MPa	3MPa
Low-side design pressures		0	0
Total effective volume		82L (21.7gal.)	86L (22.7gal.)
Net weight		35.5kg (78.3Lbs)	36kg (79.4Lbs)
Rated Voltage(V)		115V~	115V~
Rated Frequency(Hz)		60Hz	60Hz
Overall dimension		425x404x980mm	425x429x980mm
		16.73x15.91x38.58inch	16.73x16.89x38.58inch
Package dimension(mm)		480x450x1035mm	480x480x1035mm
		18.9x17.72x40.75inch	18.9x18.9x40.75inch

## NOTE

1. The electric circuit diagram and parameters on the product nameplate are final ones if they have been changed.
2. The design might be improved without notice. This appliance is not intended for use by person (including children) with reduced physical, sensory or mental capabilities, or lack of experience and knowledge, unless they have been given supervision or instruction concerning use of the appliance by a person responsible for their safety.
3. Children should be supervised to ensure that they do not play with the appliance.



### Meaning of crossed out wheeled dust bin :

Do not dispose of electrical appliances as unsorted municipal waste, please use sorted refuse collection facilities. Contact your local government for information regarding the collection systems available. If electrical appliances are disposed of in landfills or dump, hazardous substances can leak into the groundwater and get into the food chain, damaging your health and well-being.

When replacing old appliances with new ones, the retailer is legally obligated to take back your old appliance for disposals at least free of charge.

## ONE YEAR WARRANTY

Turbo Air warrants to the original purchaser of every new Turbo Air refrigerated unit, the cabinet and all parts thereof, to be free from defects in material or workmanship, under normal use and service, for a period of one (1) year from the date of original installation or 15 months after shipment date from Turbo Air, whichever occurs first.

Any parts covered by this warranty that are examined and determined by Turbo Air to have been defective within one (1) year of original installation or fifteen (15) months after shipment date from manufacturer, whichever occurs first, shall be repaired or replaced as stated below. Turbo Air shall be deemed to have fully complied with its obligation under the foregoing warranties by electing either one of the following procedures, at the sole discretion of Turbo Air.

1. Furnishing a replacement part, freight collect, in even exchange for the returned part, freight collect.
2. Receiving the defective part, freight collect; repairing it; and returning it, freight collect.

## ADDITIONAL FOUR YEAR COMPRESSOR WARRANTY

In addition to the (1) one year warranty stated above, Turbo Air warrants its hermetically and semi-hermetically sealed compressor to be free from defects in both material and workmanship under normal use and service for a period of four (4) additional years from the date of original installation but not to exceed five (5) years and three (3) months after shipment from manufacturer.

Compressors determined by Turbo Air have been defective within this extended time period will, at Turbo Air's option, be either repaired or replaced with a compressor or compressor parts of similar design and capacity.

The four (4) year extended compressor warranty applies only to hermetically and semi-hermetically sealed parts of the compressor and does not apply to any other parts or components, including, but not limited to, cabinet, paint finish, temperature control, refrigerant, metering device, driers, motor starting equipment, fan assembly any other electrical component, etcetera.

## 134A(404A) COMPRESSOR WARRANTY

The five year compressor warranty detailed above will be voided if the following procedure is not carefully adhered to:

1. This system contains R134A refrigerant and polyol ester lubricant. The Polyol ester lubricant has rapid moisture absorbing qualities. If long exposure to the ambient conditions occur, the lubricant must be removed and replaced with new. Listed below are the approved lubricants for the Tecumseh compressors.

- 1 ICI-Emkarate RL 184
- 2 Emery-2927-A
- 3 Mobile Artic 22A

Failure to comply with recommended lubricant specification will void the compressor warranty.

2. Dryer replacement is very important and must be changed when a system is opened for servicing. dryer must be used with XH-9 desiccant.
3. Micron level vacuums must be achieved to insure low moisture levels in the system. 500 microns or lower must be obtained.

## What is NOT covered by this warranty

Turbo Air's sole obligation under this warranty is limited to either repair or replacement of parts, subject to the additional limitations below. This warranty neither assumes nor authorizes any person to assume obligations other than expressly covered by this warranty.

1. **WARRANTY IS NOT TRANSFERABLE.** This warranty is not assignable and applies only in favor of the original purchaser/user to whom delivered. ANY SUCH ASSIGNMENT OR TRANSFER SHALL VOID THE WARRANTIES HEREIN MADE AND SHALL VOID ALL WARRANTIES, EXPRESS OR IMPLIED, INCLUDING ANY WARRANTY OF MERCHANTABILITY OR FITNESS FOR A PARTICULAR PURPOSE.
2. **NO CONSEQUENTIAL DAMAGES.** TURBO AIR IS NOT RESPONSIBLE FOR ECONOMIC LOSS; PROFIT LOSS OR SPECIAL, INDIRECT, OR CONSEQUENTIAL DAMAGES, INCLUDING WITHOUT LIMITATION, LOSSES OR DAMAGES ARISING FROM FOOD OR PRODUCT SPOILAGE CLAIMS WHETHER OR NOT ON ACCOUNT OF REFRIGERATION FAILURE.
3. **ALTERATION, NEGLIGENCE, ABUSE, MISUSE, ACCIDENT, DAMAGE DURING TRANSIT OR INSTALLATION, FIRE, FLOOD, ACTS OF GOD.** TURBO AIR is not responsible for the repair or replacement of any parts that Turbo Air determines have been subjected after the date of manufacture to alteration, neglect, abuse, misuse, accident, damage during transit or installation, fire, flood, or an Act of God.
4. **NO IMPLIED WARRANTY OF MERCHANTABILITY OR FITNESS FOR A PARTICULAR PURPOSE.** THERE ARE NO OTHER WARRANTIES, EXPRESS, IMPLIED OR STATUTORY, EXCEPT THE ONE(1) YEAR WARRANTY AND THE ADDITIONAL FOUR (4) YEAR COMPRESSOR WARRANTY AS DESCRIBED ABOVE. THESE WARRANTIES ARE EXCLUSIVE AND IN LIEU OF ALL OTHER WARRANTIES, INCLUDING IMPLIED WARRANTY AND MERCHANTABILITY OR FITNESS FOR A PARTICULAR PURPOSE. THERE ARE NO WARRANTIES WHICH EXTEND BEYOND THE DESCRIPTION ON THE FACE HEREOF.
5. **TRANSPORTATION COSTS.** Turbo Air will accept parts covered under this warranty freight collect, provided that shipment has received prior approval. Turbo Air is not responsible for any other transportation costs, but will ship freight collect parts either repaired or replaced under these warranties.
6. **WARRANTY CLAIMS.** All claims should include: model number of the cooler, the serial number of the cabinet, proof of purchase, date of installation, and all pertinent information supporting the existence of the alleged defect. Any action or breach of these warranty provisions must be commenced within one (1) year after that cause of action has accrued.

---

**Turbo air** REFRIGERATOR MANUFACTURER

4184 E. Conant St.  
Long Beach, CA 90808  
TEL : 310-900-1000  
FAX : 310-900-1077  
TOLL FREE : 1-800-627-0032  
(U.S.A. & Canada)  
Website : [www.turboairinc.com](http://www.turboairinc.com)

### **Warranty Claims...**

All claims for parts or labor must be made directly through Turbo Air.

All claims should include: model number of the unit, the serial number of the cabinet, proof of purchase, date of installation, and all pertinent information supporting the alleged defect.

In case of compressor replacement under warranty, either compressor or compressor tag must be returned to Turbo Air along with above listed information.

Failure to comply with warranty policies will result in voiding claims.

### **One Year Parts & Labor Warranty...**

Turbo Air warrants all new refrigerated components, the cabinet and all parts, to be free from defects in materials or workmanship, under normal and proper use and maintenance service as specified by Turbo Air and upon proper installation and start-up in accordance with the instruction packet supplied with each Turbo Air unit. Turbo Air's obligation under this warranty is limited to a period of one (1) year from the date of original installation or 15 months after shipment date from Turbo Air, whichever occurs first.

Any part, covered under this warranty, that are by Turbo Air to have been defective within one (1) year of original installation or fifteen (15) months after shipment date from manufacturer, whichever occurs first, is limited to the repair or replacement, including labor charges, of defective parts or assemblies. The labor warranty shall include standard straight time labor charges only and reasonable travel time, as determined by Turbo Air.

### **Additional Four Year Compressor Warranty...**

In addition to the one (1) year warranty stated above, Turbo Air warrants its hermetically sealed compressor to be free from defects in both material and workmanship under normal and proper use and maintenance service for a period of four (4) additional years from the date of original installation, but not to exceed five (5) years and three(3) months after shipment from the manufacturer.

Compressor determined by Turbo Air to have been defective within this extended period will, at Turbo Air's discretion, be either repaired or replaced with a compressor or compressor parts of similar design and capacity.

The four (4) year extended compressor warranty applies only to hermetically sealed parts of the compressor and does not apply to any other parts or components, including, but not limited to, cabinet, paint finish, temperature control, refrigerant, metering device, driers, motor starting equipment, fan assembly or and other electrical components, etcetera.

### **404A / 134a Compressor Warranty...**

The five-year compressor warranty detailed above will be void if the following procedure is not carefully adhered to:

1. This system contains R404A or R134a refrigerant and polyol ester lubricant. The polyol ester lubricant has rapid moisture absorbing qualities.
2. Drier replacement is very important and must be changed when a system is opened for servicing. A620 copper drier or better is highly recommended.
3. Micron level vacuums must be achieved to insure low moisture levels in the system. 500 microns or lower must be obtained.
4. When compressor is grounded, suction drier and 620 drier or better must be replaced.
5. Compressor must be obtained through Turbo Air, unless otherwise specified in writing, through Turbo Air's warranty department.

### **404A / 134a Compressor Warranty...**

Turbo Air's sole obligation under this warranty is limited to either repair or replacement of parts, subject to the additional limitations below. This warranty neither assumes nor authorizes any person to assume obligations other than those expressly covered by this warranty.

NO CONSEQUENTIAL DAMAGES. TURBO AIR IS NOT RESPONSIBLE FOR ECONOMIC LOSS; PROFIT LOSS; OR SPECIAL, INDIRECT, OR CONSEQUENTIAL DAMAGES, INCLUDING WITHOUT LIMITATION, LOSSES, OR DAMAGES ARISING FROM FOOD OR PRODUCT SPOILAGE REGARDLESS OF WHETHER OR NOT THEY RESULT FROM REFRIGERATION FAILURE. WARRANTY IS NOT TRANSFERABLE, This warranty is not assignable and applies only in favor of the original purchaser/user to whom delivered. ANY SUCH ASSIGNMENT OR TRANSFER SHALL VOID THE WARRANTIES HEREIN AND SHALL VOID ALL WARRANTIES, EXPRESS OR IMPLIED, INCLUDING ANY WARRANTY OF MERCHANTABILITY OR LABOR COVERAGE FOR COMPONENT FAILURE OR OTHER THE WARRANTY PACKET PROVIDED WITH THE UNIT. ALTERATION, NEGLIGENCE, ABUSE, MISUSE, ACCIDENT, DAMAGE DURING TRANSIT OR INSTALLATION, FIRE, FLOOD, ACTS OF GOD. Turbo Air is not responsible for the repair or replacement of any parts that Turbo Air determines have been subjected after the date of manufacture to alteration, neglect, abuse, misuse, accident, damage during transit or installation, fire, flood, or act of GOD. IMPROPER ELECTRICAL CONNECTIONS. TURBO AIR IS NOT RESPONSIBLE FOR THE REPAIR OR REPLACEMENT OF FAILED OR DAMAGED COMPONENTS RESULTING FROM ELECTRICAL POWER FAILURE, THE USE OF EXTENSION CORDS, LOW VOLTAGE, OR VOLTAGE DROPS TO THE UNIT. NO IMPLIED WARRANTY OF MERCHANTABILITY OR FITNESS FOR A PARTICULAR PURPOSE; THERE ARE NO OTHER WARRANTIES, EXPRESSED, IMPLIED OR STATUTORY, EXCEPT THE ONE (1) YEAR PARTS & LABOR WARRANTY AND THE ADDITIONAL FOUR (4) YEAR COMPRESSOR WARRANTY AS DESCRIBED ABOVE. THESE WARRANTIES ARE EXCLUSIVE AND IN LIEU OF ALL OTHER WARRANTIES, INCLUDING IMPLIED WARRANTY AND MERCHANTABILITY OR FITNESS FOR A PARTICULAR PURPOSE. THERE ARE NO WARRANTIES, WHICH EXTEND BEYOND THE DESCRIPTION ON THE FACE HEREOF.

Outside U.S. and Canada; This warranty does not apply to, and Turbo Air is not responsible for, any warranty claims made on products sold or used outside the continent of the United States and Canada.