



BEVERAGE-AIR

3779 Champion Blvd., Winston-Salem, NC 27105
1-888-845-9800 Fax# 1-336-245-6453
<http://www.Beverage-Air.com>

Item No. _____
Quantity _____

FOOD PREPARATION SERIES PREP TABLES SPED60 ELITE SERIES CUTTING TOP WITH DRAWERS

MODELS:
SPED60-C

Commercial Refrigeration Equipment General Specification

3 Year Parts/Labor Warranty Additional 2 Year Compressor Warranty

SPED60 ELITE SERIES — CUTTING TOP WITH DRAWERS

Larger 17" wide cutting board prep table. Features enhanced refrigeration system. Improved airflow for less temperature gradient and uniform temperature distribution throughout the cabinet. Pans are cooled from the bottom, eliminating the necessity of air blanket. Airflow assures that product in open containers is kept below 41°F and above freezing. This translates into increased product shelf life, higher quality food, better food appearance, fresher product and a reduction of bacteria build-up to combat food-borne illnesses.

CABINET CONSTRUCTION

Exterior construction includes heavy-duty stainless steel finish on front, sides, top, drawers and grille. Removable hoods and insulated lid assemblies are made of matching stainless steel. Cabinet back and bottom are constructed of galvanized steel. Interior liner is made of aluminum for superior resistance to corrosion.

In cabinets with doors and drawers, doors are mounted to face of cabinet on cartridge-style hinges permitting them to self close under their own weight. Hinges also allow doors to stay open 120° and permit easy door removal for service and cleaning if required. A plug-in type vinyl magnetic gasket is attached to each door for positive seal.

Drawer frames are constructed of heavy-duty stainless steel and are supported on heavy-duty telescoping drawer slides for maximum support of stored food products. The drawer slides have a locking mechanism that prevents the drawers from being inadvertently pulled off the cabinets. Upper pull-out drawers accommodate 4" deep pans. Lower pull-out drawers accommodate up to 6" deep pans. Heavy-duty pan divider supports are supplied. Foodservice pans for drawers are not included. Snap-type vinyl magnetic gasket is attached to each drawer for positive seal. Top drawer extends 17 3/4" (when opened) and bottom drawer extends 15 3/4" (when opened).

Cabinet insulation is CFC and HCFC-free foamed-in-place polyurethane of two-inch minimum thickness. Six-inch casters, 2 with brakes, are standard. Legs are available as an option.

Cutting board supplied with cabinet is 17" wide constructed of high-density white polyethylene plastic. It is readily removable for cleaning. Pans furnished for top are 4" deep and made of polycarbonate plastic.

REFRIGERATION

More robust refrigeration system provides added capacity and efficiency. Systems are designed using CFC and HCFC-free R134a refrigerant. Recirculated, forced air from evaporator is moved under pans, which are recessed 2" from top of cabinet. Forced air over the condenser is drawn through grille under bottom drawer as well as the back and bottom of cabinet. Automatic condensate evaporator is provided to eliminate the need of floor drains.



SPED60-16C-2 (pictured)

ELECTRICAL CONNECTION

Units pre-wired at factory and include 8' long cord and plug set.



Available From:



*Note: Not all markings may apply to all model variations.

Model Specified _____	Store# _____
Location _____	Quantity _____



PLAN VIEWS

Food Prep Table — Cutting Top With Drawers
Models: SPED60

MODEL	SPED60-08C-2	SPED60-08C-4	SPED60-10C-2	SPED60-10C-4	SPED60-12C-2	SPED60-12C-4	SPED60-16C-2	SPED60-16C-4
EXTERNAL DIMENSIONAL DATA								
Length Overall (inches)	60"	60"	60"	60"	60"	60"	60"	60"
Length Overall (mm)	1524	1524	1524	1524	1524	1524	1524	1524
Depth Overall (inches)	36"	36"	36"	36"	36"	36"	36"	36"
Depth Overall (mm)	914	914	914	914	914	914	914	914
Height Overall—(inches)	41 11/16"	41 11/16"	41 11/16"	41 11/16"	41 11/16"	41 11/16"	41 11/16"	41 11/16"
Height Overall—(mm)	1059	1059	1059	1059	1059	1059	1059	1059
Number of drawers	2	4	2	4	2	4	2	4
Number of doors	1	-	1	-	1	-	1	-
Top Drawer Extension (when opened)	17 3/4"	17 3/4"	17 3/4"	17 3/4"	17 3/4"	17 3/4"	17 3/4"	17 3/4"
Bottom Drawer Extension (when opened)	15 3/4"	15 3/4"	15 3/4"	15 3/4"	15 3/4"	15 3/4"	15 3/4"	15 3/4"
INTERNAL DIMENSIONAL DATA								
NET Capacity (cubic ft.)	17.1	17.1	17.1	17.1	17.1	17.1	17.1	17.1
NET Capacity (Liters)	484	484	484	484	484	484	484	484
Internal Length Overall (inches)	56"	56"	56"	56"	56"	56"	56"	56"
Internal Length Overall (mm)	1422	1422	1422	1422	1422	1422	1422	1422
Internal Depth Overall (inches)	19"	19"	19"	19"	19"	19"	19"	19"
Internal Depth Overall (mm)	483	483	483	483	483	483	483	483
Internal Height Overall—(inches)	23"	23"	23"	23"	23"	23"	23"	23"
Internal Height Overall—(mm)	584	584	584	584	584	584	584	584
ELECTRICAL DATA								
Full Load Amperes 115/60/1	9.6	9.6	9.6	9.6	9.6	9.6	9.6	9.6
REFRIGERATION DATA								
Horsepower	1/3	1/3	1/3	1/3	1/3	1/3	1/3	1/3
WEIGHT DATA								
Gross Weight (Crated lbs)	355	360	355	360	355	360	355	360
Gross Weight (Crated kg)	161	163	161	163	161	163	161	163

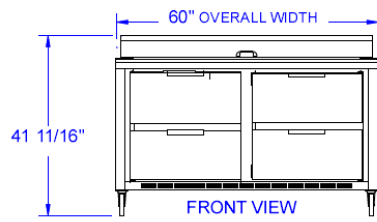
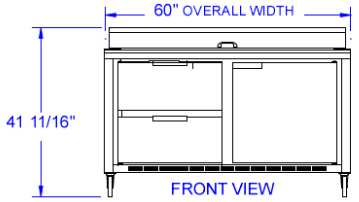
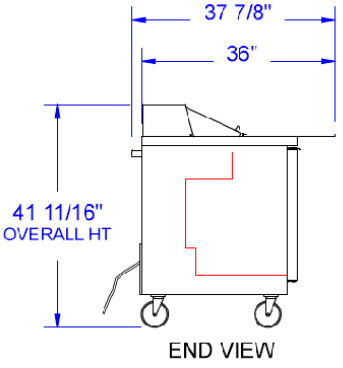

Note: Not all markings may apply to all model variations.
***N/A:** Not available at time of printing.

TOP PAN CONFIGURATIONS

DRAWER SUPPORT CAPACITY		
MODEL	# OF PAN SUPPORTS (SUPPLIED)	POSSIBLE PAN COMBINATION
SPED60	2	1 FULL SIZE PAN
		2 HALF SIZE PANS
		6 1/6TH SIZE PANS
		3 1/3RD SIZE PANS

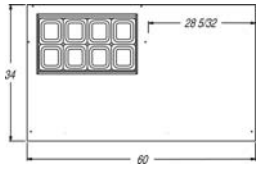

SPED60-08C

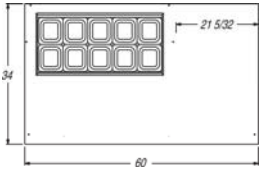

SPED60-10C

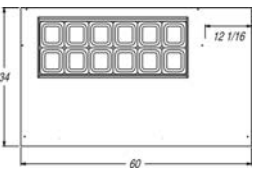

SPED60-12C

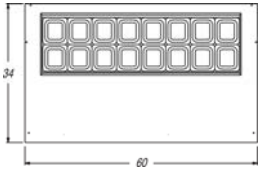

SPED60-16C

BEVERAGE-AIR® CORPORATION