

# SILH Series

## Silhouette Enclosed Tack Boards

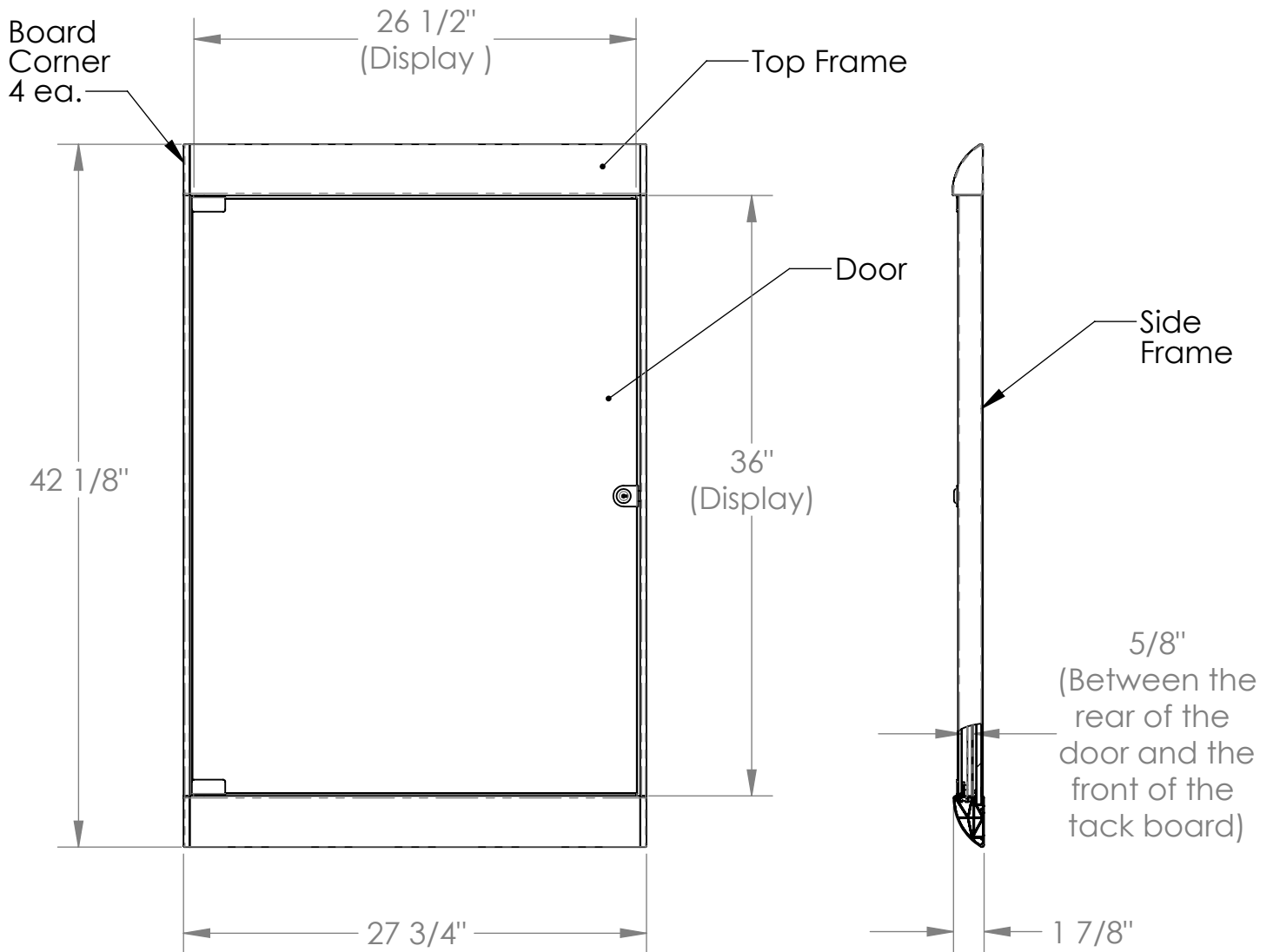

### Materials:

- Framework: aluminum extrusion.
- Door : 1/4" thick tempered glass.
- Tack panels : 3/8" thick fiber board covered in either "Flair Performance Fabric" or "PremaTak Vinyl" fabric.
- Door lock and hinges - chrome plated steel
- Door lock mount plate - polished stainless steel.
- Board corners - black thermoplastic.
- Door stop bumpers - black rubber.

### Features:

- Matching top and bottom frames finishes: satin aluminum, wood-look cherry, or wood-look maple.
- Frameless door for optimum viewing
- 2 cleat style hanger rails are included.
- Letter size paper display capacity: 3 across / 3 down (Portrait)  
2 across / 4 down (Landscape)
- Tack panels are available in 15 colors (see sheet 2)
- Can be mounted so that the door opens from the left or right.

### Notes:

- Units with "Flair Performance Fabric" tack panels have black satin anodized side frames.
- Units with "PremaTak Vinyl" tack panels have clear satin anodized aluminum side frames.
- Unit weight - 31 Lbs.

## Flair Performance Fabric Colors



201 - Twilight



202 - Forest



203- Cabernet



204 -Camel

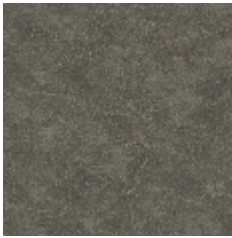

205 - Charcoal

## PremaTak Vinyl Colors

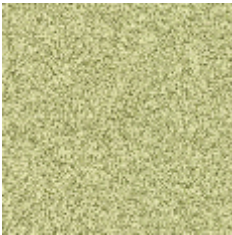

181 - Caramel

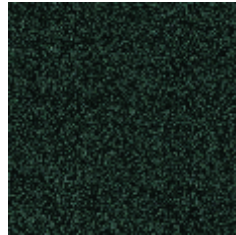

183 - Ebony



185 - Ivory

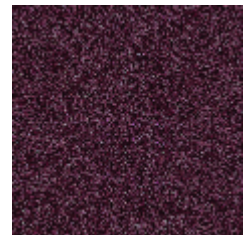

187 - Berry

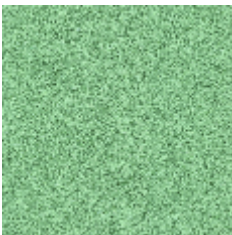

189 - Mint

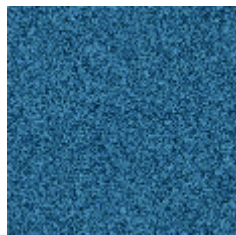

191 - Ocean



193 - Silver

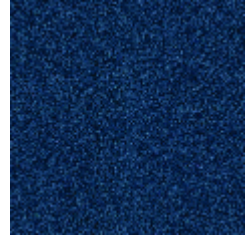

195 - Navy



197 - Spruce

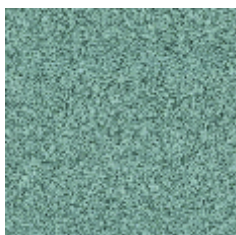

199 - Stone