

# Rear View Camera System for Chevrolet Express Vans

Product Manual / Installation Instructions



Rear View Camera Systems  
Model # RVS-770913

Rear View Safety, Inc. © 2014

 REAR VIEW  
**SAFETY**  
REVERSE WITH CONFIDENCE™

# What's in the Box?



- 1 Color MT9V136 Weather Proof Backup Camera with Infrareds
- 1 DIGITAL 7" TFT LCD Color Rear View Monitor with Universal Mount
- 1 3 Channel Multiplexer Control Unit
- 1 33' Extension Cable for Camera
- 1 Remote Control
- 1 Power Connection Wire
- 1 Double RCA + Power Converter  
(to connect external audio, video and power)
- 1 Screw Kit for Installation

# Table of Contents

Introduction.....	4
Safety Information.....	5
Before Beginning Installation.....	6
Installation Guide.....	7
Wiring Camera & Monitor.....	8-9
Installation Diagram .....	10
Installation Monitor .....	11
Positioning.....	12
Multiplexer .....	13
Monitor Dimensions.....	14
Monitor Specifications.....	15
Camera Dimensions.....	16
Camera Specifications.....	17
Splitting & Splicing .....	18
Troubleshooting.....	19
Warranty.....	20

# Introduction

Please read all of the installation instructions carefully before installing the product. Improper installation will void manufacturer's warranty.

Congratulations on purchasing a Rear View Backup Camera System. With this manual you will be able to properly install and operate the unit.

The Backup Camera System is intended to be installed as a supplement aid to your standard rear view mirror that already exists in your vehicle. The Backup Camera System should not be used as a substitute for the standard rear view mirror or for any other mirror that exists in your vehicle.

In some jurisdictions, it is unlawful for a person to drive a motor vehicle equipped with a TV viewer or screen located forward of the back of the driver's seat or in any location that is visible, directly or indirectly, to the driver while operating the vehicle.

## Safety Information

Please read the entire manual and follow the instructions and warnings carefully. Failure to do so can cause serious damage and/or injury, including loss of life. Be sure to obey all applicable local traffic and motor vehicle regulations as it pertains to this product. Improper installation will void manufacturer's warranty.

### USAGE

- The Rear View Camera System is designed to help the driver safely detect people and/or objects helping to avoid damage or injury. However, you the driver, must use it properly. Use of this system is not a substitute for safe, proper or legal driving.
- Never back up while looking at the monitor alone. You should always check behind and around the vehicle when backing up, in the same way as you would if the vehicle did not have the Rear View Camera System. If you back up while looking only at the monitor, you may cause damage or injury. Always back up slowly.
- The Rear View Camera System is not intended for use during extensive back-up maneuvers or backing into cross traffic or pedestrian walkways.
- Please, always remember, the area displayed by the Rear View Camera System is limited. It does not display the entire panorama that is behind you.

# Safety Information

## INSTALLATION

- Electric shock or product malfunction may occur if this product is installed incorrectly.
- Use this product within the voltage range specified. Failure to do so can cause electronic shock or product malfunction.
- Take special care when cleaning the monitor.
- Make sure to firmly affix the product before use.
- If smoke or a burning smell is detected, disconnect the system immediately.
- Where the power cable may touch a metal case, cover the cable with a friction tape. A short circuit or disconnected wire may cause a fire.
- While installing the Rear View System be careful with the wire positioning in order to avoid wire damage
- The Rear View System should only be used when the vehicle is in reverse.
- Do not watch movies or operate the monitor while driving; as it may cause an accident.
- Do not install the monitor where it may obstruct drivers view or obstruct an air bag device.
- Dropping the unit may cause possible mechanical failure.

## Safety Information

If you have questions about this product, contact:

Customer Service:  
Rear View Safety  
1797 Atlantic Avenue  
Brooklyn, NY 11233  
Tel: 1.800.764.1028

IN NO EVENT SHALL SELLER OR MANUFACTURER BE  
LIABLE FOR ANY DIRECT OR CONSEQUENTIAL DAMAGES OF  
ANY NATURE, OR LOSSES OR EXPENSES RESULTING FROM  
ANY DEFECTIVE PRODUCT OR THE USE OF ANY PRODUCT.



## Before You Begin Installation

Before drilling please check that no cable or wiring is on the other side of the wall. Please clamp all wires securely to reduce the possibility of them being damaged while vehicle is in use. Keep all cables away from hot or moving parts and electrical noisy components.

We recommend doing a benchmark test before installation to insure that all components are working properly.

Step 1: Choose the monitor and camera locations.

Step 2: Install all cables in vehicle, when necessary a 0.8 (20mm) hole should be drilled for passing camera cable through vehicles walls. Install split grommets where applicable

Step 3: Once all cables and wiring have been properly placed routed, perform a system function test by temporarily connecting the system. If the problem persists see troubleshooting (page 22).



# Installation Guide

## Camera

1. Attach camera bracket close to rear marker lights, centered on vehicle.
2. Attach camera to bracket using screws provided and adjust the angle.

## Cable

1. Be sure to position the cable properly. The aviation camera cable uses aircraft grade connectors which means the camera cable can be exposed to all weather elements, do not run the cable over sharp edges, do not kink the cable and keep away from HOT and rotating parts.
2. Fasten all cable and secure all excess cable.

## Monitor

1. The Mirror Monitor attaches to the existing rear view mirror in vehicle with the pressurized clips on the back of the monitor..
2. Attach monitor to existing mirror, and adjust mounting angle to allow optimum driver viewing comfort. (see figure 1.1 on page 12).

## Wiring Camera & Monitor

- When installing a ONE (1) camera setup, connect camera extension cable from the rear view camera to port # labeled "backup" (most systems port 3) Connect red 12V+ wire to ignition power source and black wire 12V- to chassis ground. Do not use white and yellow wires.
- The blue wire is the REVERSE trigger wire. In typical rear-view installations, connecting this wire to the vehicle's backup light circuit will activate the rear-view image whenever the vehicle shifts into reverse.
- Before drilling, be sure no cable or wire is on the other side.
- Feed as much cable as possible into vehicle and clamp securely. This reduces the possibility of cable being hooked or snagged.
- Camera: Drill a 20mm (0.8in) diameter hole into vehicle body near the camera and bracket. Insert camera cable into vehicle (be careful not to kink cable) and fit grommet into hole. Apply sealant around grommet to increase resistance to water penetration. Connect camera to the camera extension cable which runs inside the vehicle.
- The camera system can be wired to be powered "ON" the entire time the vehicle is activated and this is typical in RV and some Commercial applications.
- The camera and monitor can always be activated by manually pushing the power button on monitor this is in addition to utilizing the positive triggers.

Note: If connecting power directly to battery, the camera is always ON and therefore can drain battery, therefore its recommended to connect power to an ignition switched accessory power source.

## Wiring Camera & Monitor

- Audio works on two ports of multiplexer and positive triggers must be triggered for audio to operate. #3 Port labeled "backup" (blue trigger) #2 port labeled "DVD" (white Trigger).
- When installing a TWO (2) camera setup, use ports #3 and #2 and use positive triggers Blue and White.
- There is a built-in voltage regulator for our systems which can handle 12-24 volts real consumption is 10 to 30 Volts.
- When installing all THREE (3) cameras, use all three ports and connect all positive triggers to appropriate connections.

To automatically have camera and monitor turn ON when vehicle activates, simply twist BLUE positive trigger 12V+ to Red Power line 12V+ and wire to ignition power which can be an accessory switch/fuse line and black wire 12V- to chassis ground.

Infrared technology built into camera IRs are activated automatically according to the lighting conditions.

When using the positive trigger functions (blue, yellow & white wires) each trigger function needs to work on a separate 12V+ source i.e. the Yellow and White wires can be wired to a turn signal circuit etc. Grid lines function can be turned on/off by pushing MENU 8 times and then select ON/OFF

# Installation Diagram

**Figure 1.1**

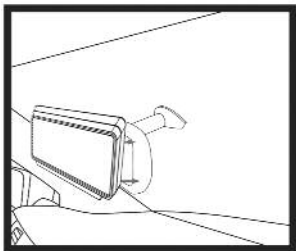

**Figure 1.2**

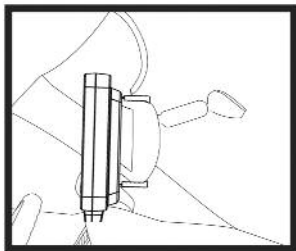

**Figure 1.3**

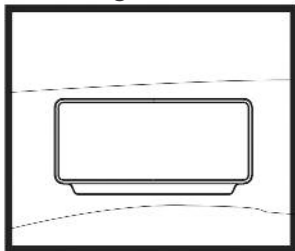

# Installing the Monitor

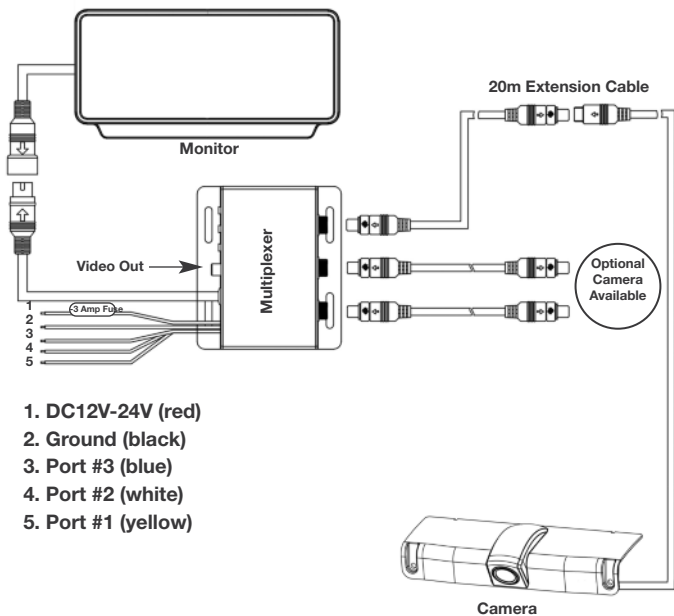

# Monitor Operation



- To turn on the monitor, press "ON" button.
- To adjust brightness, press "MENU" 1 time and use arrows
- To adjust contrast, press "MENU" 2 times and use arrows
- To adjust saturation, press "MENU" 3 times and use arrows
- To adjust sharpness, press "MENU" 4 times and use arrows
- To adjust volume, press "MENU" 5 times and use arrows
- To change language, press "MENU" 6 times and use arrows
- To activate rotate image option, press "MENU" 7 times and use arrows.
- To adjust distance grid, press "MENU" 8 times and use arrows
- To adjust grid position, press "MENU" 9 times and use arrows
- To activate day/night option, press "MENU" 10 times and use arrows
- To reset your system, press "MENU" 11 times and use arrows
- To view images on other cameras, press "CAMERA SELECTION"  
1 time for camera one, 2 times for camera two and 3 times for camera three.

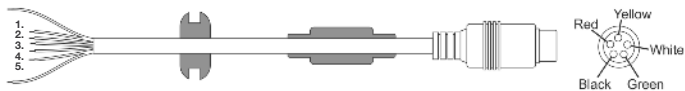

- 1. Red - Power (+)**
- 2. Yellow - Video**
- 3. Green - Mirror / Normal Imaging**
- 4. White - Audio**
- 5. Black - Ground (-)**

# Positioning

## Rear Camera Positioning

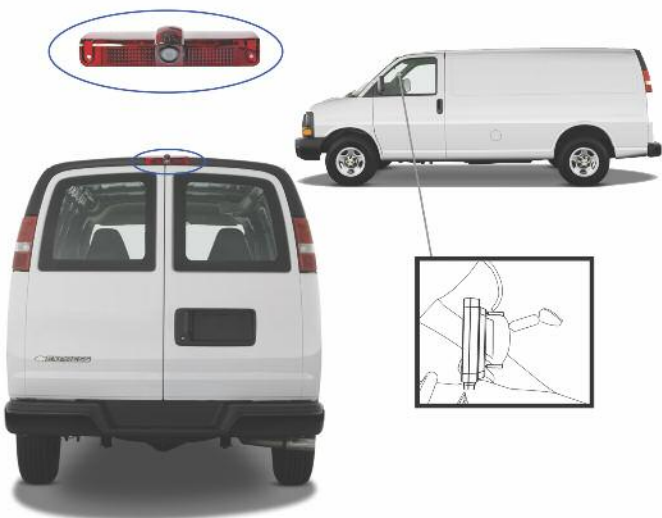



# Multiplexer

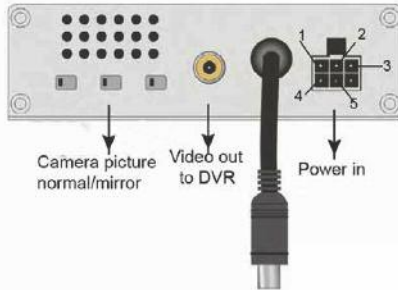

Pin Number	Description
1	Blue: Reverse Gear Power circuit port #3
2	Yellow: Camera - Port #1
3	Red: DC12-24V power input
4	White: Camera Port #2
5	Black: Ground

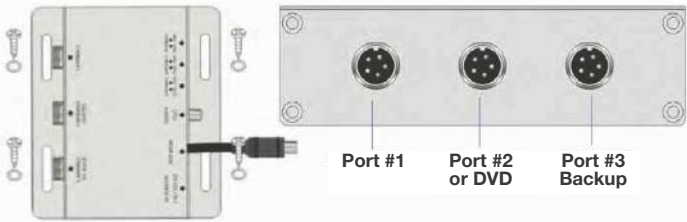

# Monitor Dimensions

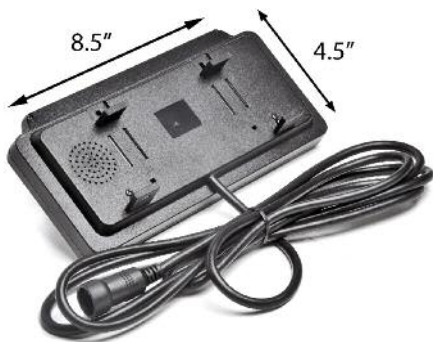
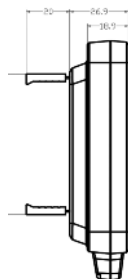
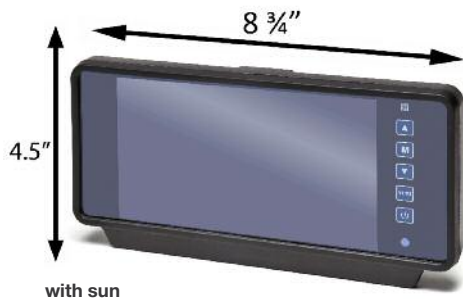

# Monitor Specifications

TFT LCD Digital Monitor	
Screen Size	7"
Dot Resolution	800 x 3 (RGB) x 480
Display Format	16:9
Display Brightness	400cd/m <sup>2</sup>
Viewing Angle	U:50/D:60 L/R:70
Video Input	3 channel
Video Source	1Vp-p, 75Ω
Power Supply	DC 12V-24V (+/-10%)
Power Consumption	5W
Operating Temperature	-10°C - +80° C
Video System	Auto NTSC/PAL
Overall Dimensions	7"L x 5"H x 1"D
Weight	400G
Impact Rating	5G
Dot Pitch	154.08H x 86.8V
Sync System	Internal

## Camera Dimensions

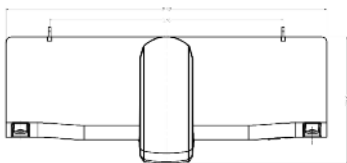
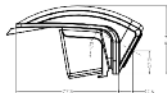
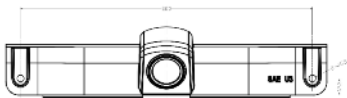
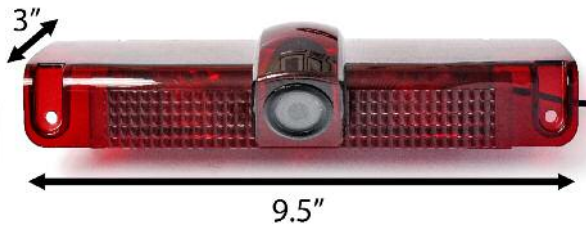

## Camera Specifications

Camera	MTV9V136
Picture Elements	250,000 pixels
Gamma Correction	$r=0.45$ to 1.0
Image Sensor	480TV lines PAL:500H x 582V / NTSC:510H x 492V
Lens	2.1mm
View Angle	130°
Sync System	Internal Synchronization
Night Vision	Yes
Usable Illumination	0 Lux (IR On)
Power Source	DC 12V (+/-10%)
S/N Ratio	More than 48dB
Electronic Iris	1/50, 160-1/100,000sec
Video Output	1Vp.p 75ohm
IR Switch Control	CDS Automatic Control
Impact Rating	10G Shock
Operating Temperature	-30°C - +80°C / RH 95% Max
Storage Temperature	-30°C - +60°C / RH 95% Max

# Troubleshooting

## Monitor Display Blue Screen & Displays No Signal

- Do a hard reset, unplug all cables and power cables from multiplexer (silver box) leave out for 1 minute and then re-connect them.
  - Check to ensure that the connection to the camera is tight.
  - Verify camera cable is plugged into port labeled Backup Camera
  - Verify that the blue positive trigger on power harness is put to power 12v+.
- If the problem still persists, verify that alternate ports work. If alternate ports do not work, remove Blue Trigger wire from 12V+ and select alternate channels.

## Monitor Will Not Power-Up (no backlight on power button)

- Check fuse
- Check 12v+ to monitor
- Check ground connection

## No Image On Screen

- Verify camera is on correct camera input
- Verify cable is connected to monitor
- Verify camera is connected to cable
- Connect known working camera and cable to monitor.
- Verify Blue trigger is receiving power

## Audio on Camera

- Verify chosen camera has audio
- Verify volume setting
- Confirm that the Blue audio trigger is connected to 12v+

## One Year Warranty

Rear View Safety Inc. warrants this product against material defects for a period of one year from date of purchase. We reserve the right to repair or replace any such defective unit at our sole discretion.

Rear View Safety Inc. is not responsible for a defect in the system as a result of misuse, improper installation, damage or mis-handling of the electronic components. Rear View Safety Inc. is not responsible for consequential damages of any kind.

This warranty is void if: defects in materials or workmanship or damages result from repairs or alterations which have been made or attempted by others or the unauthorized use of nonconforming parts; the damage is due to normalware and tear, this damage is due to abuse, improper maintenance, neglect or accident: or the damage is do to use of the Rear View Safety Inc. system after partial failure or use with improper accessories.

## Warranty Performance

DURING THE ABOVE WARRANTY PERIOD, SHOULD YOUR REAR VIEW SAFETY PRODUCT EXHIBIT A DEFECT IN MATERIAL OR WORKMANSHIP, SUCH DEFECT WILL BE REPAIRED WHEN THE COMPLETE REAR VIEW SAFETY INC. PRODUCT IS RETURNED, POSTAGE PREPAID AND INSURED, TO REAR VIEW SAFETY INC. OTHER THAN THE POSTAGE AND INSURANCE REQUIREMENT, NO CHARGE WILL BE MADE FOR REPAIRS COVERED BY THIS WARRANTY.

## Warranty Disclaimers

NO WARRANTY, ORAL OR WRITTEN, EXPRESSED OR IMPLIED, OTHER THE ABOVE WARRANTY IS MADE WITH REGARD TO THIS REAR VIEW SAFETY INC. REAR VIEW SAFETY INC. DISCLAIMS ANY IMPLIED WARRANTY OR MERCHANTABILITY OR FITNESS FOR A PARTICULAR USE OR PURPOSE AND ALL OTHER WARRANTIES IN NO EVENT SHALL REAR VIEW SAFETY INC. LIABLE FOR ANY INCIDENTAL, SPECIAL, CONSEQUENTIAL, OR PUNITIVE DAMAGES OR FOR ANY COSTS, ATTORNEY FEES, EXPENSES, LOSSES OR DELAYS ALLEGED TO BE AS A CONSEQUENCE OF ANY DAMAGE TO, FAILURE OF, OR DEFECT IN ANY PRODUCT INCLUDING, BUT NOT LIMITED TO, ANY CLAIMS FOR LOSS OF PROFITS

## Disclaimer

Rear View Safety and/or its affiliates does not guarantee or promise that the user of our systems will not be in/part of an accident or otherwise not collide with an object and/or person. Our systems are not a substitute for careful and cautious driving or for the consistent adherence to all applicable traffic laws and motor vehicle safety regulations. The Rear View Safety products are not a substitute for rearview mirrors or for any other motor vehicle equipment mandated by law. Our camera systems have a limited field of vision and do not provide a comprehensive view of the rear or side area of the vehicle. Always make sure to look around your vehicle and use your mirrors to confirm rearward clearance and that your vehicle can maneuver safely. Rear View Safety and/or its affiliates shall have no responsibility or liability for damage and/or injury resulting from accidents occurring with vehicles having some of Rear View Safety products installed and Rear View Safety and/or its affiliates, the manufacturer, distributor and seller shall not be liable for any injury, loss or damage, incidental or consequential, arising out of the use or intended use of the product. In no event shall Rear View Safety and/or its affiliates have any liability for any losses (whether direct or indirect, in contract, tort or otherwise) incurred in connection with the systems, including but not limited to damaged property, personal injury and/or loss of life. Neither shall Rear View Safety and/or its affiliates have any responsibility for any decision, action or inaction taken by any person in reliance on Rear View Safety systems, or for any delays, inaccuracies and/or errors in connection with our systems functions.



## Take Notes



---

---

---

---

---

---

---

---

---

---

---

---

---

---

---

---

---

---

---

---

---

---

---

---





**If you have any questions  
about this product, contact:**

**Rear View Safety, Inc.  
1797 Atlantic Avenue  
Brooklyn, NY 11233  
800.764.1028**

**BETTER CAMERAS. BETTER SERVICE.  
IT'S OUR GUARANTEE.**

