

# Ultra-Drop™ Drop-In Anchors



## Description

The Ultra-Drop™ Drop-in Anchor is an **internally threaded**, flush mount, expansion anchor designed for use in solid concrete, stone, and solid block based materials. The Ultra-Drop features a **knurled body** that increases friction between the anchor body and the internal walls of the hole.

Options include: standard, coil thread, lipped and mini. The standard drop-in anchors are also available in 304SS and 316SS.

## Key Features & Benefits

- ▶ Easy to install using a hammer (or mallet) and a setting tool
- ▶ Internally threaded anchor allows easy bolt removability and service work
- ▶ Two-piece anchor comprised of internally threaded anchor body and an expansion cone insert
  - Case hardened expansion cone insert prevents galling and binding during expansion
- ▶ Tapered bottom lip provides maximum depth and holding power
- ▶ Anchor design offers consistent holding power in shallow embedment
- ▶ Eliminates requirement for rod couplings in overhead applications
- ▶ Internal thread\* accepts UNC bolts or threaded bolts
  - Coil thread style accepts standard coil thread rod or coil thread bolts
- ▶ Available in a variety of materials:
  - Zinc-plated carbon steel
  - 304 stainless steel
  - 316 stainless steel

### Internal Threads\*

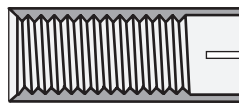

Standard, Lipped and Mini Anchors accept UNC standard thread

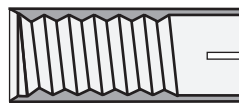

Coil Thread Anchors accept standard coil thread

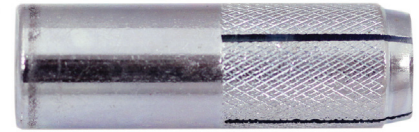

Standard and Coil Thread

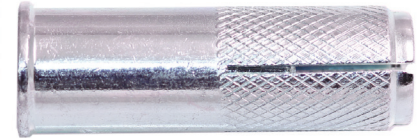

Lipped



Mini



## Specifications, Listings and Approvals

### Materials:

Carbon steel with zinc plating  
– ASTM B633 Type III, SC1 (clear chromate added)

Type 304 and Type 316 stainless steel

### Internal Thread\*:

UNC coarse thread or standard coil thread

– 1/4" - 3/4" UNC Coarse Thread

– 1/2" & 3/4" Coil Thread

### Federal Specifications:

GSA FFS-325, Group VIII, Type I

## Applications

- ▶ Conduit Suspension
- ▶ Cable Trays & Strut
- ▶ Pipe Supports
- ▶ Fire Sprinklers
- ▶ Utilities
- ▶ Suspended Lighting

## Installation Information

### Instructions

1. Drill the hole perpendicular to the work surface at the required embedment depth. To assure full holding power, do not ream the hole or allow the drill to wobble.
2. Clean the hole using compressed air and a nylon brush.
3. Place the anchor into the hole. Make sure that the top of the anchor is flush with, or below, the level of the work surface.
4. Insert the setting tool into the threaded end of the anchor and expand the anchor by striking the end of the setting tool with a hammer. The anchor is set (fully expanded) when the shoulder of the setting tool touches the anchor. **Full expansion is necessary for proper anchor performance.**
5. The anchor is now ready to accept threaded hardware.

**NOTE: Always wear safety glasses.** Follow the drill manufacturer's safety instructions. Use only solid carbide-tipped drill bits meeting ANSI B212.15 diameter standards.

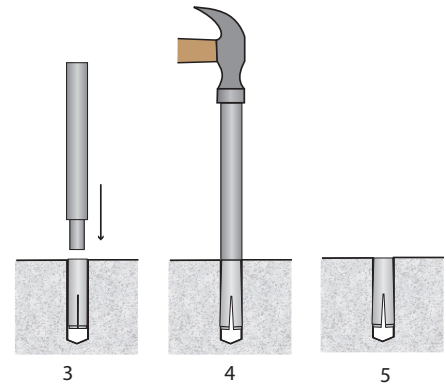
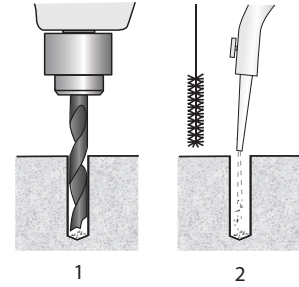

### Length Selection

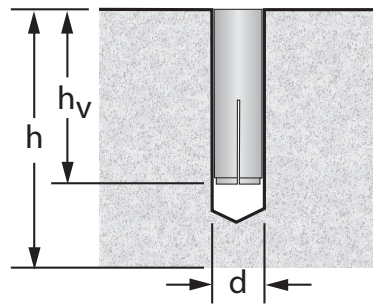

h<sub>v</sub>: Minimum embedment depth  
h: Base material thickness  
d: Anchor diameter  
Note: Anchor diameter = drill bit diameter



## Installation Data

### Standard, Lipped and Coil Thread

Anchor Thread Dia. (in.)	Drill Bit Dia. (in.)	Thread Size (UNC)	Thread Depth (in.)	Anchor Length/Min. Embed. Depth (in.)	Installation Torque Approx. (ft-lb.)	Critical Edge Distance (in.)	Min. Edge Dist. (in.)	Critical Spacing (in.)	Min. Spacing (in.)
1/4	3/8	1/4 - 20	7/16	1	5	3 - 1/2	1 - 3/4	3	1 - 1/2
3/8	1/2	3/8 - 16	3/4	1-9/16	10	5 - 1/4	2 - 5/8	4 - 1/2	2 - 1/4
1/2	5/8	1/2 - 13	13/16	2	20	7	3 - 1/2	6	3
1/2 Coil Thread	5/8	1/2 - 6	13/16	2	20	7	3 - 1/2	6	3
5/8	7/8	5/8 - 11	1 - 7/16	2-1/2	40	8 - 3/4	4 - 3/8	7 - 1/2	3 - 3/4
3/4	1	3/4 - 10	1 - 3/8	3-1/4	80	10 - 1/2	5 - 1/4	9	4 - 1/2
3/4 Coil Thread	1	3/4 - 4-1/2	1 - 3/8	3-1/4	80	10 - 1/2	5 - 1/4	9	4 - 1/2

### Mini

Anchor Thread Dia. (in.)	Drill Bit Dia. (in.)	Thread Size (UNC)	Thread Depth (in.)	Anchor Length/Min. Embed. Depth (in.)	Installation Torque Approx. (ft-lb.)	Critical Edge Distance (in.)	Min. Edge Dist. (in.)	Critical Spacing (in.)	Min. Spacing (in.)
1/4	3/8	1/4 - 20	3/8	5/8	3	3	1 - 1/2	1 - 7/8	15/16
3/8	1/2	3/8 - 16	7/16	3/4	5	4 - 1/2	2 - 1/4	2 - 1/4	1 - 1/8
1/2	5/8	1/2 - 13	5/8	1	10	6	3	3	1 - 1/2

## Performance Data – Standard/Lipped/Coil Thread Anchors

### Ultimate and Allowable Loads (lbs.) – Normal-Weight Concrete

Anchor Thread Dia. (in.)	Min. Embed. Depth (in.)	Allowable						Ultimate					
		2,000 psi		4,000 psi		6,000 psi		2,000 psi		4,000 psi		6,000 psi	
		Tension	Shear	Tension	Shear	Tension	Shear	Tension	Shear	Tension	Shear	Tension	Shear
1/4	1	378	458	510	495	528	533	1510	1830	2040	1980	2110	2130
3/8	1-1/2	650	1095	1048	1148	1258	1178	2600	4380	4190	4590	5030	4710
1/2	2	1188	1560	1460	1603	1790	1655	4750	6240	5840	6410	7160	6620
5/8	2-1/2	1348	2520	2100	3010	2768	3245	5390	10080	8400	12040	11070	12980
3/4	3-1/4	2275	3670	2588	3868	3125	4085	9100	14680	10350	15470	12500	16340

\*Allowable load capacities are calculated using an applied safety factor of 4:1

### Ultimate and Allowable Loads (lbs.) – Structural Lightweight Concrete

Anchor Thread Dia. (in.)	Min. Embed. Depth (in.)	Allowable						Ultimate					
		2,000 psi		4,000 psi		6,000 psi		2,000 psi		4,000 psi		6,000 psi	
		Tension	Shear	Tension	Shear	Tension	Shear	Tension	Shear	Tension	Shear	Tension	Shear
1/4	1	278	458	418	495	463	533	1110	1830	1670	1980	1850	2130
3/8	1-1/2	748	1095	973	1148	1160	1178	2990	4380	3890	4590	4640	4710
1/2	2	1163	1560	1243	1603	1485	1655	4650	6240	4970	6410	5940	6620
5/8	2-1/2	1495	2520	2030	3010	2195	3245	5980	10080	8120	12040	8780	12980
3/4	3-1/4	2350	3670	2883	3868	3240	4085	9400	14680	11530	15470	12960	16340

\*Allowable load capacities are calculated using an applied safety factor of 4:1

## Load Adjustment Factors – Standard/Lipped/Coil Thread Anchors

### Spacing in Normal-Weight and Lightweight Concrete (Tension and Shear)

Anchor Thread Dia.	1/4	3/8	1/2	5/8	3/4	
Embedment $h_v$	1	1-1/2	2	2-1/2	3-1/4	
Critical Spacing $S_{cr}$	3	4-1/2	6	7-1/2	9-3/4	
Min. Spacing $S_{min}$	1-1/2	2-1/4	3	3-3/4	4-7/8	
Actual Spacing $S_{act}$	1-1/2	0.50	–	–	–	
	2-1/4	0.75	0.50	–	–	
	3	1.00	0.67	0.50	–	
	3-3/4	–	0.83	0.63	0.50	
	4-1/2	–	1.00	0.75	0.60	
	4-7/8	–	–	0.81	0.65	0.50
	6	–	–	1.00	0.80	0.62
	7-1/2	–	–	–	1.00	0.77
9-3/4	–	–	–	–	1.00	

For tension and shear anchor loads, the critical spacing ( $S_{cr}$ ) is equal to 3 embedment depths at which the anchor achieves 100% of load. Minimum spacing ( $S_{min}$ ) is equal to 1.5 embedment depths at which the anchor achieves 50% of load.

### Edge in Normal-Weight Concrete (Tension)

Anchor Thread Dia.	1/4	3/8	1/2	5/8	3/4	
Critical Edge Dist. $C_{cr}$	3-1/2	5-1/4	7	8-3/4	10-1/2	
Min. Edge Dist. $C_{min}$	1-3/4	2-5/8	3-1/2	4-3/8	5-1/4	
Actual Edge Dist. $C_{act}$	1-3/4	0.90	–	–	–	
	2-5/8	0.95	0.90	–	–	
	3-1/2	1.00	0.93	0.90	–	
	4-3/8	–	0.97	0.93	0.90	
	5-1/4	–	1.00	0.95	0.92	0.90
	7	–	–	1.00	0.96	0.93
	8-3/4	–	–	–	1.00	0.97
	10-1/2	–	–	–	–	1.00

For tension anchor loads, the critical edge distance ( $C_{cr}$ ) is equal to 14 anchor diameters at which the anchor achieves 100% of load. Minimum edge distance ( $C_{min}$ ) is equal to 7 anchor diameters at which the anchor achieves 90% of load.

### Edge in Lightweight Concrete (Tension)

Anchor Thread Dia.	1/4	3/8	1/2	5/8	3/4	
Critical Edge Dist. $C_{cr}$	3-1/2	5-1/4	7	8-3/4	10-1/2	
Min. Edge Dist. $C_{min}$	1-3/4	2-5/8	3-1/2	4-3/8	5-1/4	
Actual Edge Dist. $C_{act}$	1-3/4	0.80	–	–	–	
	2	0.83	–	–	–	
	2-5/8	0.90	0.80	–	–	
	3-1/2	1.00	0.87	0.80	–	
	4-3/8	–	0.93	0.85	0.80	
	5-1/4	–	1.00	0.90	0.84	0.80
	7	–	–	1.00	0.92	0.87
	8-3/4	–	–	–	1.00	0.93
	10-1/2	–	–	–	–	1.00

For tension anchor loads, the critical edge distance ( $C_{cr}$ ) is equal to 14 anchor diameters at which the anchor achieves 100% of load. Minimum edge distance ( $C_{min}$ ) is equal to 7 anchor diameters at which the anchor achieves 80% of load.

### Edge in Normal-Weight Concrete (Shear)

Anchor Thread Dia.	1/4	3/8	1/2	5/8	3/4	
Critical Edge Dist. $C_{cr}$	3-1/2	5-1/4	7	8-3/4	10-1/2	
Min. Edge Dist. $C_{min}$	1-3/4	2-5/8	3-1/2	4-3/8	5-1/4	
Actual Edge Dist. $C_{act}$	1-3/4	0.50	–	–	–	
	2	0.57	–	–	–	
	2-5/8	0.75	0.50	–	–	
	3	0.86	0.57	–	–	
	3-1/2	1.00	0.67	0.50	–	
	4-3/8	–	0.83	0.63	0.50	
	5-1/4	–	1.00	0.75	0.60	0.50
	6	–	–	0.86	0.69	0.57
	7	–	–	1.00	0.80	0.67
	8	–	–	–	0.91	0.76
	8-3/4	–	–	–	1.00	0.83
	10-1/2	–	–	–	–	1.00

For shear anchor loads, the critical edge distance ( $C_{cr}$ ) is equal to 14 anchor diameters at which the anchor achieves 100% of load. Minimum edge distance ( $C_{min}$ ) is equal to 7 anchor diameters at which the anchor achieves 50% of load.

## Performance Data – Mini Anchors

### Ultimate and Allowable Loads (lbs.) – Normal-Weight Concrete

Anchor Thread Dia. (in.)	Min. Embed. Depth (in.)	Allowable						Ultimate					
		2,000 psi		4,000 psi		6,000 psi		2,000 psi		4,000 psi		6,000 psi	
		Tension	Shear	Tension	Shear	Tension	Shear	Tension	Shear	Tension	Shear	Tension	Shear
1/4	5/8	248	283	285	385	303	405	990	1130	1140	1540	1210	1620
3/8	3/4	445	608	543	945	583	1043	1780	2430	2170	3780	2330	4170
1/2	1	755	990	820	1188	920	1198	3020	3960	3280	4750	3680	4790

\*Allowable load capacities are calculated using an applied safety factor of 4:1

## Load Adjustment Factors – MINI Anchors

### Spacing in Normal-Weight and Lightweight Concrete (Tension and Shear)

Anchor Thread Dia.	1/4	3/8	1/2
Embedment $h_v$	5/8	3/4	1
Critical Spacing $S_{cr}$	1-7/8	2-1/4	3
Min. Spacing $S_{min}$	15/16	1-1/8	1-1/2
Actual Spacing $S_{act}$	15/16	0.50	–
	1-1/8	0.60	0.50
	1-1/2	0.80	0.67
	1-7/8	1.00	0.83
	2-1/4	–	1.00
3	–	–	1.00

\*For tension and shear anchor loads, the critical spacing ( $S_{cr}$ ) is equal to 3 embedment depths at which the anchor achieves 100% of load. Minimum spacing ( $S_{min}$ ) is equal to 1.5 embedment depths at which the anchor achieves 50% of load.

### Edge in Normal-Weight Concrete (Tension)

Anchor Thread Dia.	1/4	3/8	1/2
Critical Edge Dist. $C_{cr}$	3	4-1/2	6
Min. Edge Dist. $C_{min}$	1-1/2	2-1/4	3
Actual Edge Dist. $C_{act}$	1-1/2	0.90	–
	2-1/4	0.95	0.90
	3	1.00	0.93
	4-1/2	–	1.00
	6	–	–

\*For tension anchor loads, the critical edge distance ( $C_{cr}$ ) is equal to 12 diameters at which the anchor achieves 100% of load. Minimum edge distance ( $C_{min}$ ) is equal to 6 anchor diameters at which the anchor achieves 90% of load.

### Edge in Normal-Weight Concrete (Shear)

Anchor Thread Dia.	1/4	3/8	1/2
Critical Edge Dist. $C_{cr}$	3	4-1/2	6
Min. Edge Dist. $C_{min}$	1-1/2	2-1/4	3
Actual Edge Dist. $C_{act}$	1-1/2	0.75	–
	2-1/4	0.88	0.75
	3	1.00	0.83
	4-1/2	–	1.00
	6	–	–

\*For shear anchor loads, the critical edge distance ( $C_{cr}$ ) is equal to 12 diameters at which the anchor achieves 100% of load. Minimum edge distance ( $C_{min}$ ) is equal to 6 anchor diameters at which the anchor achieves 75% of load.

## Order Information



Standard: Zinc-Plated Carbon Steel					
Catalog No.	Drill Bit Dia. (in.)	Thread Size (UNC)	Anchor Length (in.)	Box Quantity	Carton Quantity
WD14	3/8	1/4 - 20	1	100	1000
WD38	1/2	3/8 - 16	1-5/8	50	500
WD12	5/8	1/2 - 13	2	50	500
WD58	7/8	5/8 - 11	2-1/2	25	200
WD34	1	3/4 - 10	3-1/4	25	150

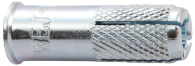

Lipped: Zinc-Plated Carbon Steel					
Catalog No.	Drill Bit Dia. (in.)	Thread Size (UNC)	Anchor Length (in.)	Box Quantity	Carton Quantity
WDL14	3/8	1/4 - 20	1	100	1000
WDL38	1/2	3/8 - 16	1-5/8	50	500
WDL12	5/8	1/2 - 13	2	50	500



Coil Thread: Zinc-Plated Carbon Steel					
Catalog No.	Drill Bit Dia. (in.)	Thread Size (UNC)	Anchor Length (in.)	Box Quantity	Carton Quantity
WDCT12	5/8	1/2 - 6	2	50	500
WDCT34	1	3/4 - 4-1/2	3-1/4	25	150



MINI: Zinc-Plated Carbon Steel					
Catalog No.	Drill Bit Dia. (in.)	Thread Size (UNC)	Anchor Length (in.)	Box Quantity	Carton Quantity
WDM14	3/8	1/4 - 20	5/8	100	1000
WDM38	1/2	3/8 - 16	3/4	50	500
WDM12	5/8	1/2 - 13	1	50	400



Standard: Type 304 Stainless Steel					
Catalog No.	Drill Bit Dia. (in.)	Thread Size (UNC)	Anchor Length (in.)	Box Quantity	Carton Quantity
WDS14	3/8	1/4 - 20	1	100	1000
WDS38	1/2	3/8 - 16	1-5/8	50	500
WDS12	5/8	1/2 - 13	2	50	500
WDS58	7/8	5/8 - 11	2-1/2	25	200
WDS34	1	3/4 - 10	3-1/4	25	150



Standard: Type 316 Stainless Steel					
Catalog No.	Drill Bit Dia. (in.)	Thread Size (UNC)	Anchor Length (in.)	Box Quantity	Carton Quantity
WDSS14	3/8	1/4 - 20	1	100	1000
WDSS38	1/2	3/8 - 16	1-5/8	50	500
WDSS12	5/8	1/2 - 13	2	50	500
WDSS58	7/8	5/8 - 11	2-1/2	25	200
WDSS34	1	3/4 - 10	3-1/4	25	150



Setting Tools			
Catalog No.		Sets Anchor Thread Size (in.)	Quantity
ST14	STM14*	1/4	1
ST38	STM38*	3/8	1
ST12	STM12*	1/2	1
ST58	-	5/8	1
ST34	-	3/4	1

\* Mini Ultra-Drop Drop-In Anchor Setting Tools