

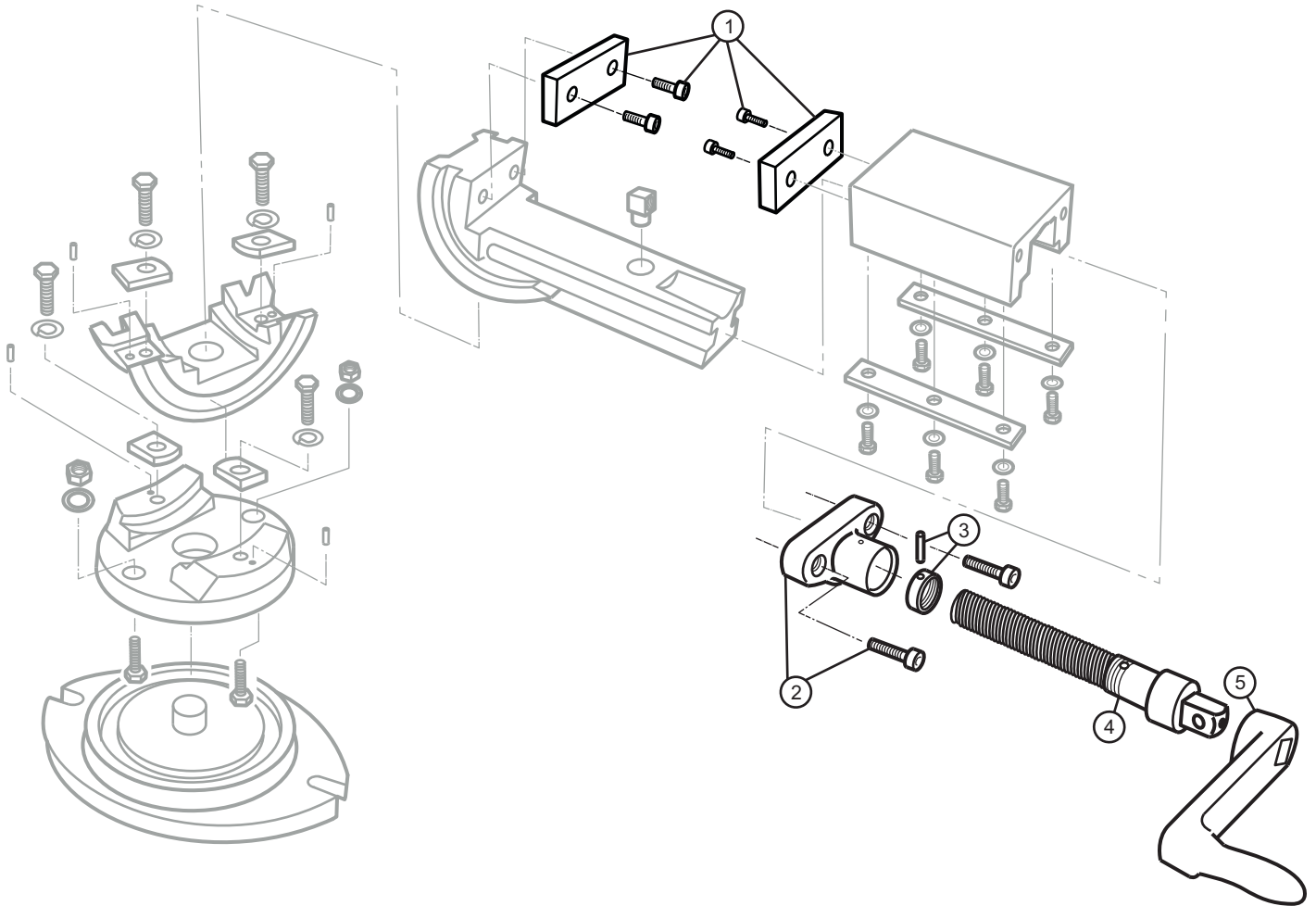

Super Precision 3-Axis Tilting Machine Vise Parts Diagram

4" Jaw Width, 4" Jaw Opening, 1-9/16" Jaw Depth

Stock #: 11702 Model #: TLT/SP-100



#	Part	Description
1	11702-01	Jaw Insert Assembly
2	11702-02	Sleeve and Socket Head (2)
3	11702-03	Collar and Roll Pin
4	11702-04	Clamp Screw
5	11702-05	Handle