



No.:

Date: 26-DEC-2012

Customer :

TECHNICAL PROPOSAL

Three-phase induction motor - Squirrel cage rotor

Product line : Three-Phase: W22 IEEE-841™ Petrochem Motors - NEMA Premium® Efficiency

Catalog Number : 00112ST3QIE145TC-W22

List Price : \$1,112

Notes:

Performed by:

Checked:



No.:

Date: 26-DEC-2012

DATA SHEET

Three-phase induction motor - Squirrel cage rotor

Customer :
Product line : Three-Phase: W22 IEEE-841™ Petrochem Motors - NEMA Premium® Efficiency

Frame : 145T
Output : 1 HP
Frequency : 60 Hz
Poles : 6
Full load speed : 1150
Slip : 4.17 %
Voltage : 460 V
Rated current : 1.73 A
Locked rotor current : 10.7 A
Locked rotor current (I_L/I_n) : 6.2
No-load current : 1.09 A
Full load torque : 4.51 lb.ft
Locked rotor torque : 300 %
Breakdown torque : 300 %
Design : B
Insulation class : F
Temperature rise : 80 K
Locked rotor time : 28 s (hot)
Service factor : 1.25
Duty cycle : S1
Ambient temperature : -20°C - +40°C
Altitude : 1000
Degree of Protection : IP55
Approximate weight : 53 lb
Moment of inertia : 0.15947 sq.ft.lb
Noise level : 49 dB(A)

	D.E.	N.D.E.	Load	Power factor	Efficiency (%)
Bearings	6205 C3	6204 C3	100%	0.66	82.5
Regreasing interval	20000 h	20000 h	75%	0.57	82.0
Grease amount	4 g	4 g	50%	0.45	77.0

Notes:

Performed by

Checked



No.:

Date: 26-DEC-2012

PERFORMANCE CURVES RELATED TO RATED OUTPUT

Three-phase induction motor - Squirrel cage rotor

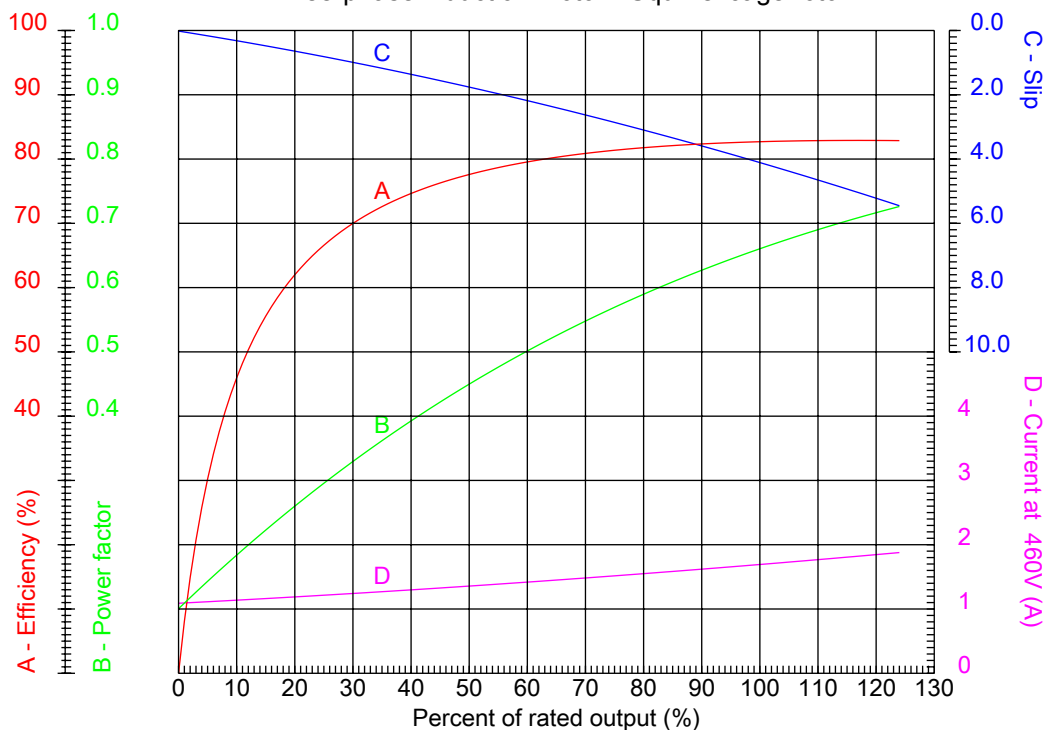

Customer :
Product line : Three-Phase: W22 IEEE-841™ Petrochem Motors - NEMA Premium® Efficiency

Frame : 145T	Locked rotor current (I _L /I _n) : 6.2
Output : 1 HP	Duty cycle : S1
Frequency : 60 Hz	Service factor : 1.25
Full load speed : 1150	Design : B
Voltage : 460 V	Locked rotor torque : 300 %
Rated current : 1.73 A	Breakdown torque : 300 %
Insulation class : F	

Notes:

Performed by

Checked



No.:

Date: 26-DEC-2012

CHARACTERISTIC CURVES RELATED TO SPEED

Three-phase induction motor - Squirrel cage rotor

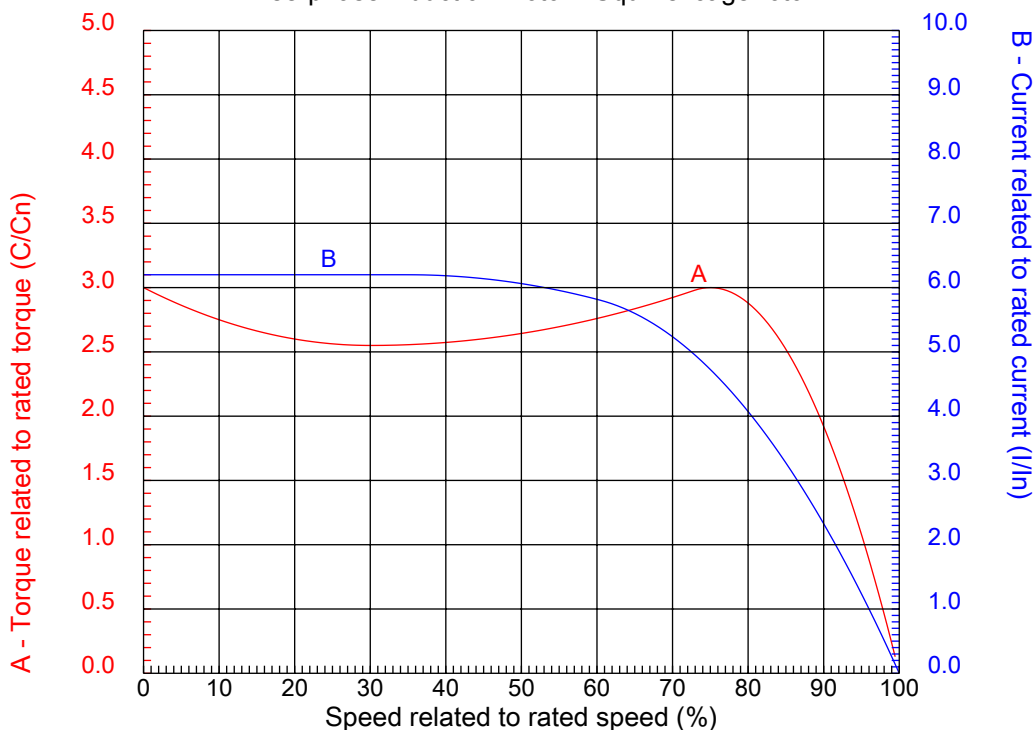

Customer :
Product line : Three-Phase: W22 IEEE-841™ Petrochem Motors - NEMA Premium® Efficiency

Frame	: 145T	Locked rotor current (I _l /I _n)	: 6.2
Output	: 1 HP	Duty cycle	: S1
Frequency	: 60 Hz	Service factor	: 1.25
Full load speed	: 1150	Design	: B
Voltage	: 460 V	Locked rotor torque	: 300 %
Rated current	: 1.73 A	Breakdown torque	: 300 %
Insulation class	: F		

Notes:

Performed by

Checked

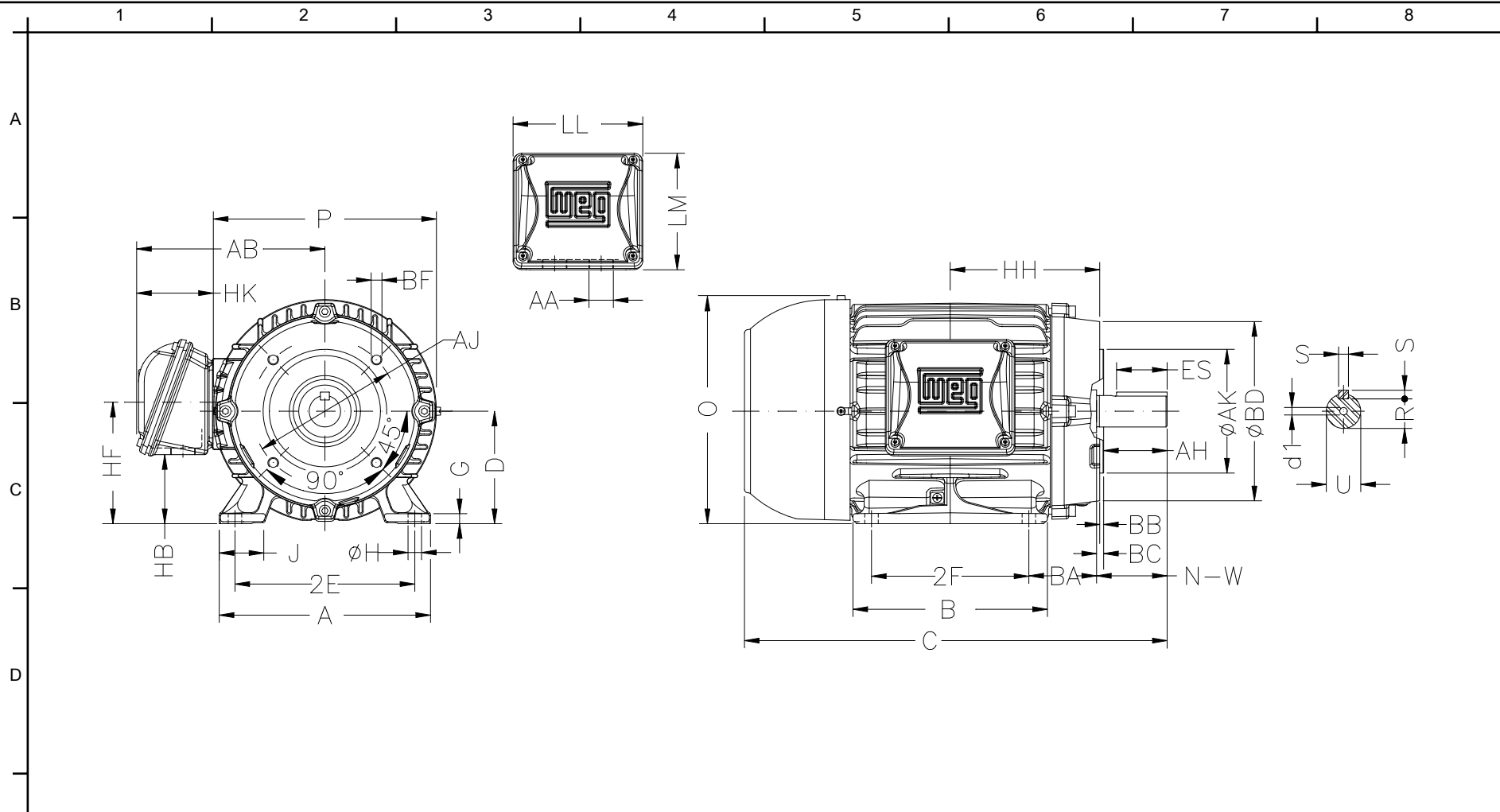

E	2E 5.500	J 1.437	A 6.457	P 7.047	AB 6.181
	2F 5.000	B 6.142	BA 2.250	U 0.875	N-W 2.250
	ES 1.417	S 0.187	R 0.765	depth 0.187	D 3.500
	G 0.354	HB 1.728	O 7.122	HF 3.500	HH 4.750
	HK 2.638	H 0.344	C 13.346	LL 4.527	LM 4.094
F	AA NPT 3/4"	d1 A 4	d2 A 4	Flange FC-149	AJ 5.875
	AK 4.500	BD 6.500	BF UNC 3/8"x16	BB 0.156	BC 0.125
	AH 2.125				

Notes:		
Performed by:		
Checked:		
Customer:		
Three-Phase: W22 IEEE-841™ Petrochem Motors - NEMA Premium® Efficiency		
Three-phase induction motor Frame 145T - IP55	26-DEC-2012	