



No.:

Date: 27-DEC-2012

Customer :

TECHNICAL PROPOSAL

Three-phase induction motor - Squirrel cage rotor

Product line : Three-Phase : Explosion Proof - NEMA Premium

Catalog Number : 00212XT3H184T

List Price : \$1,158

Notes:

Performed by:

Checked:



No.:

Date: 27-DEC-2012

DATA SHEET

Three-phase induction motor - Squirrel cage rotor

Customer :
Product line : Three-Phase : Explosion Proof - NEMA Premium

Frame : 184T
Output : 2 HP
Frequency : 60 Hz
Poles : 6
Full load speed : 1165
Slip : 2.92 %
Voltage : 575 V
Rated current : 2.50 A
Locked rotor current : 17.5 A
Locked rotor current (I_L/I_n) : 7.0
No-load current : 1.68 A
Full load torque : 8.89 lb.ft
Locked rotor torque : 260 %
Breakdown torque : 330 %
Design : B
Insulation class : F
Temperature rise : 80 K
Locked rotor time : 35 s (hot)
Service factor : 1.15
Duty cycle : S1
Ambient temperature : -20°C - +40°C
Altitude : 1000
Degree of Protection : IP54
Approximate weight : 129 lb
Moment of inertia : 0.53226 sq.ft.lb
Noise level : 52 dB(A)

	D.E.	N.D.E.	Load	Power factor	Efficiency (%)
Bearings	6307 ZZ	6206 ZZ	100%	0.68	88.5
Regreasing interval	---	---	75%	0.58	86.5
Grease amount	---	---	50%	0.47	84.5

Notes:

Performed by

Checked



No.:

Date: 27-DEC-2012

PERFORMANCE CURVES RELATED TO RATED OUTPUT
Three-phase induction motor - Squirrel cage rotor

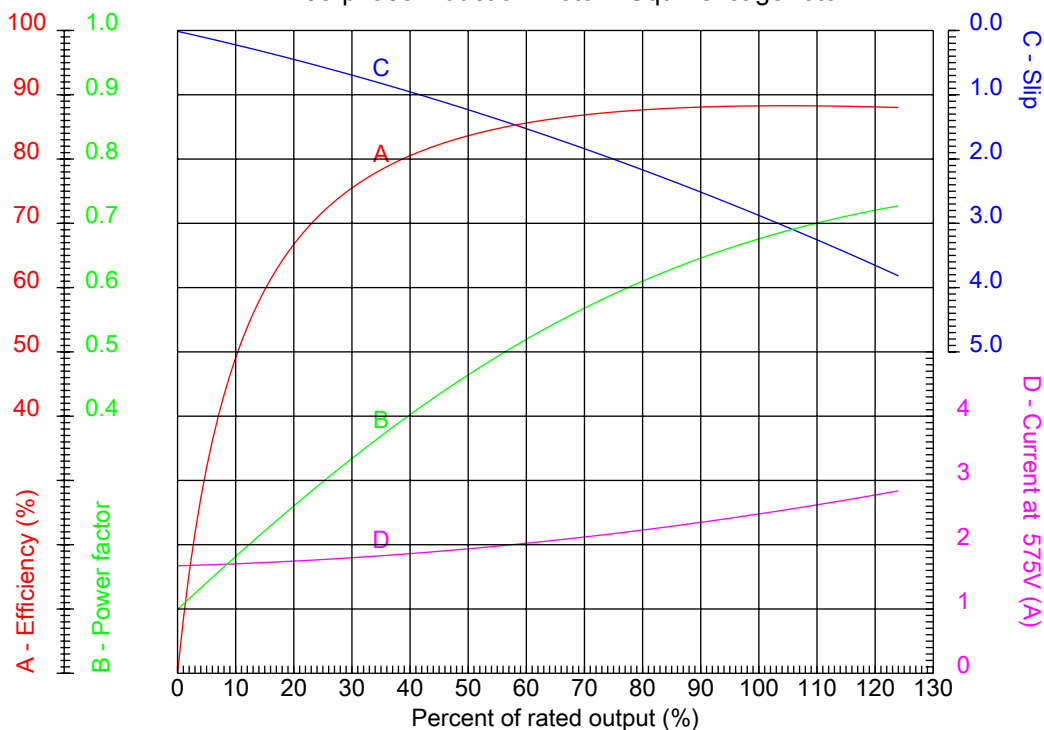

Customer :
Product line : Three-Phase : Explosion Proof - NEMA Premium

Frame	: 184T	Locked rotor current (I _L /I _n)	: 7.0
Output	: 2 HP	Duty cycle	: S1
Frequency	: 60 Hz	Service factor	: 1.15
Full load speed	: 1165	Design	: B
Voltage	: 575 V	Locked rotor torque	: 260 %
Rated current	: 2.50 A	Breakdown torque	: 330 %
Insulation class	: F		

Notes:

Performed by

Checked



No.:

Date: 27-DEC-2012

CHARACTERISTIC CURVES RELATED TO SPEED

Three-phase induction motor - Squirrel cage rotor

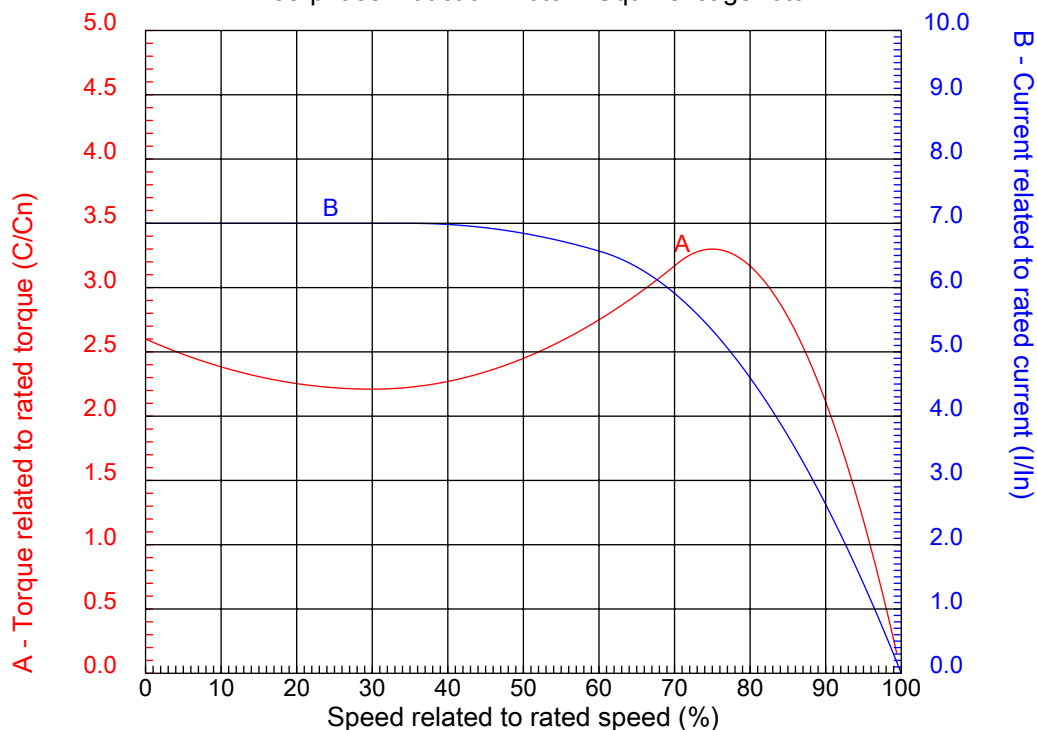

Customer :
Product line : Three-Phase : Explosion Proof - NEMA Premium

Frame	: 184T	Locked rotor current (I _l /I _n)	: 7.0
Output	: 2 HP	Duty cycle	: S1
Frequency	: 60 Hz	Service factor	: 1.15
Full load speed	: 1165	Design	: B
Voltage	: 575 V	Locked rotor torque	: 260 %
Rated current	: 2.50 A	Breakdown torque	: 330 %
Insulation class	: F		

Notes:

Performed by

Checked

1 2 3 4 5 6 7 8

A

B

C

D

E

F

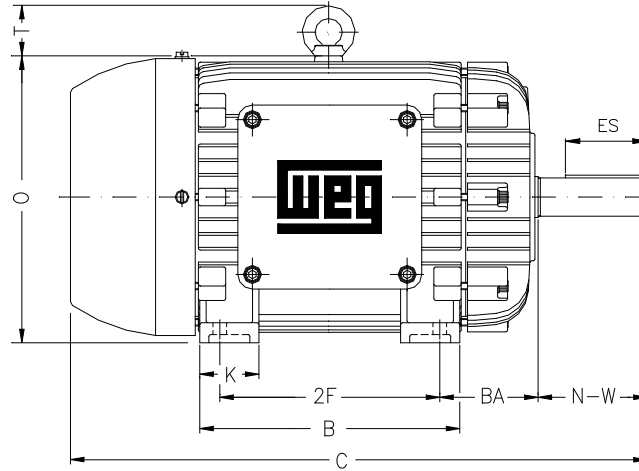

Notes:

Performed by:

Checked:

Customer:

Three-Phase : Explosion Proof - NEMA Premium

Three-phase induction motor
Frame 184T - IP54

27-DEC-2012



2E 7.500	A 8.661	2F 5.500	B 6.969	BA 2.750
J 1.890	K 1.969	P 8.909	ES 1.969	depth 0.250
S 0.250	N-W 2.750	U 1.125	R 0.984	AB 8.240
D 4.500	G 0.787	O 9.421	HD 11.193	H 0.406
C 15.862	AA NPT 3/4"	d1 A 4	d2 A 4	T 1.772
Flange FD-254	AJ 10.000	AK 9.000	BD 11.000	BF 0.562
BB 0.203				