



No.:

Date: 26-DEC-2012

Customer :

TECHNICAL PROPOSAL

Three-phase induction motor - Squirrel cage rotor

Product line : Three-Phase: W22 IEEE-841™ Petrochem Motors - NEMA Premium® Efficiency

Catalog Number : 00236ST3HIE145T-W22

List Price : \$1,023

Notes:

Performed by:

Checked:



No.:

Date: 26-DEC-2012

DATA SHEET

Three-phase induction motor - Squirrel cage rotor

Customer :
Product line : Three-Phase: W22 IEEE-841™ Petrochem Motors - NEMA Premium® Efficiency

Frame : 145T
Output : 2 HP
Frequency : 60 Hz
Poles : 2
Full load speed : 3480
Slip : 3.33 %
Voltage : 575 V
Rated current : 2.05 A
Locked rotor current : 18.2 A
Locked rotor current (I_L/I_n) : 8.9
No-load current : 0.792 A
Full load torque : 2.98 lb.ft
Locked rotor torque : 350 %
Breakdown torque : 380 %
Design : B
Insulation class : F
Temperature rise : 80 K
Locked rotor time : 17 s (hot)
Service factor : 1.25
Duty cycle : S1
Ambient temperature : -20°C - +40°C
Altitude : 1000
Degree of Protection : IP55
Approximate weight : 52 lb
Moment of inertia : 0.06051 sq.ft.lb
Noise level : 68 dB(A)

	D.E.	N.D.E.	Load	Power factor	Efficiency (%)
Bearings	6205 C3	6204 C3	100%	0.86	85.5
Regreasing interval	20000 h	20000 h	75%	0.80	85.5
Grease amount	4 g	4 g	50%	0.71	82.5

Notes:

Performed by

Checked



No.:

Date: 26-DEC-2012

PERFORMANCE CURVES RELATED TO RATED OUTPUT
Three-phase induction motor - Squirrel cage rotor

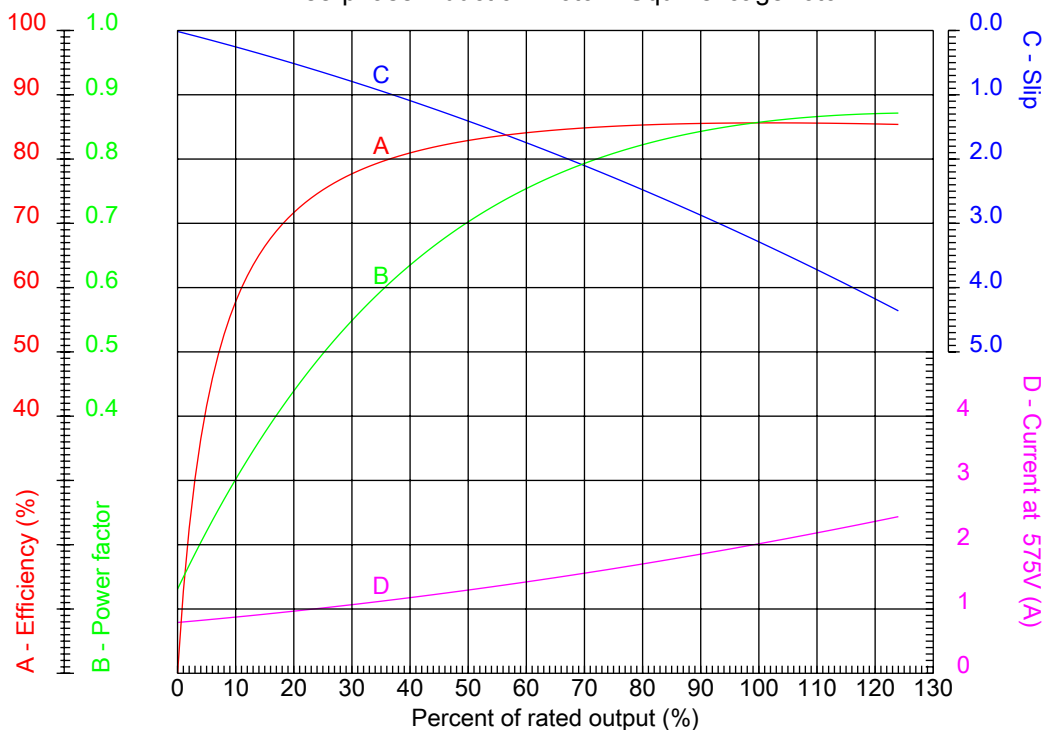

Customer :
Product line : Three-Phase: W22 IEEE-841™ Petrochem Motors - NEMA Premium® Efficiency

Frame	: 145T	Locked rotor current (I _l /I _n)	: 8.9
Output	: 2 HP	Duty cycle	: S1
Frequency	: 60 Hz	Service factor	: 1.25
Full load speed	: 3480	Design	: B
Voltage	: 575 V	Locked rotor torque	: 350 %
Rated current	: 2.05 A	Breakdown torque	: 380 %
Insulation class	: F		

Notes:

Performed by

Checked



No.:

Date: 26-DEC-2012

CHARACTERISTIC CURVES RELATED TO SPEED Three-phase induction motor - Squirrel cage rotor

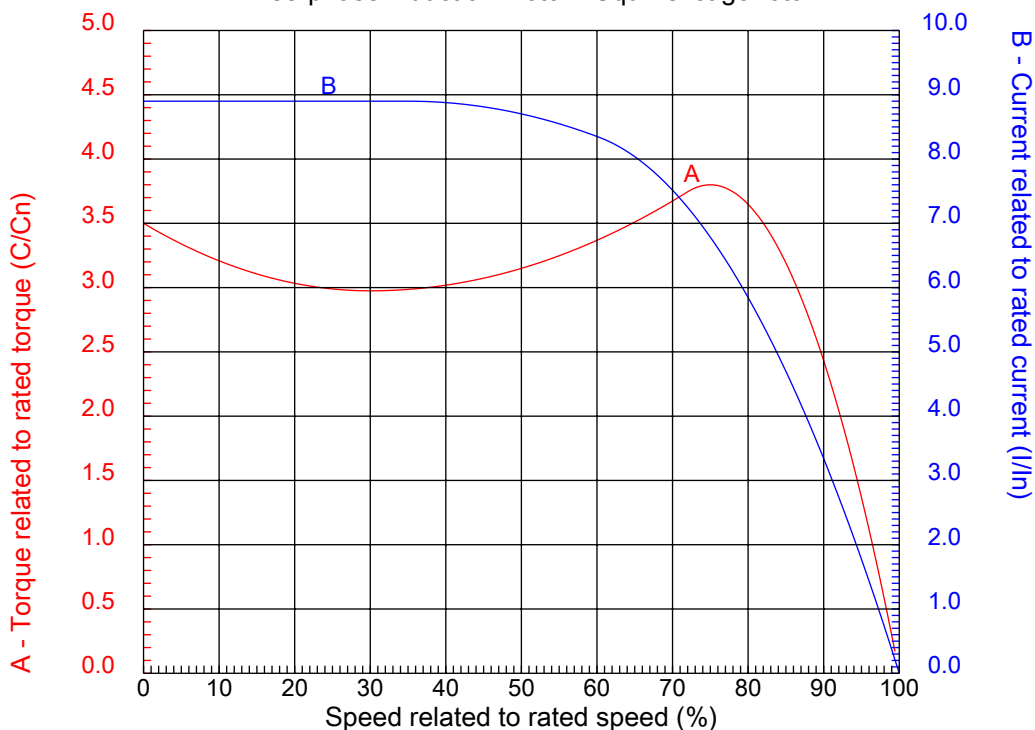

Customer :
Product line : Three-Phase: W22 IEEE-841™ Petrochem Motors - NEMA Premium® Efficiency

Frame	: 145T	Locked rotor current (I _l /I _n)	: 8.9
Output	: 2 HP	Duty cycle	: S1
Frequency	: 60 Hz	Service factor	: 1.25
Full load speed	: 3480	Design	: B
Voltage	: 575 V	Locked rotor torque	: 350 %
Rated current	: 2.05 A	Breakdown torque	: 380 %
Insulation class	: F		

Notes:

Performed by

Checked

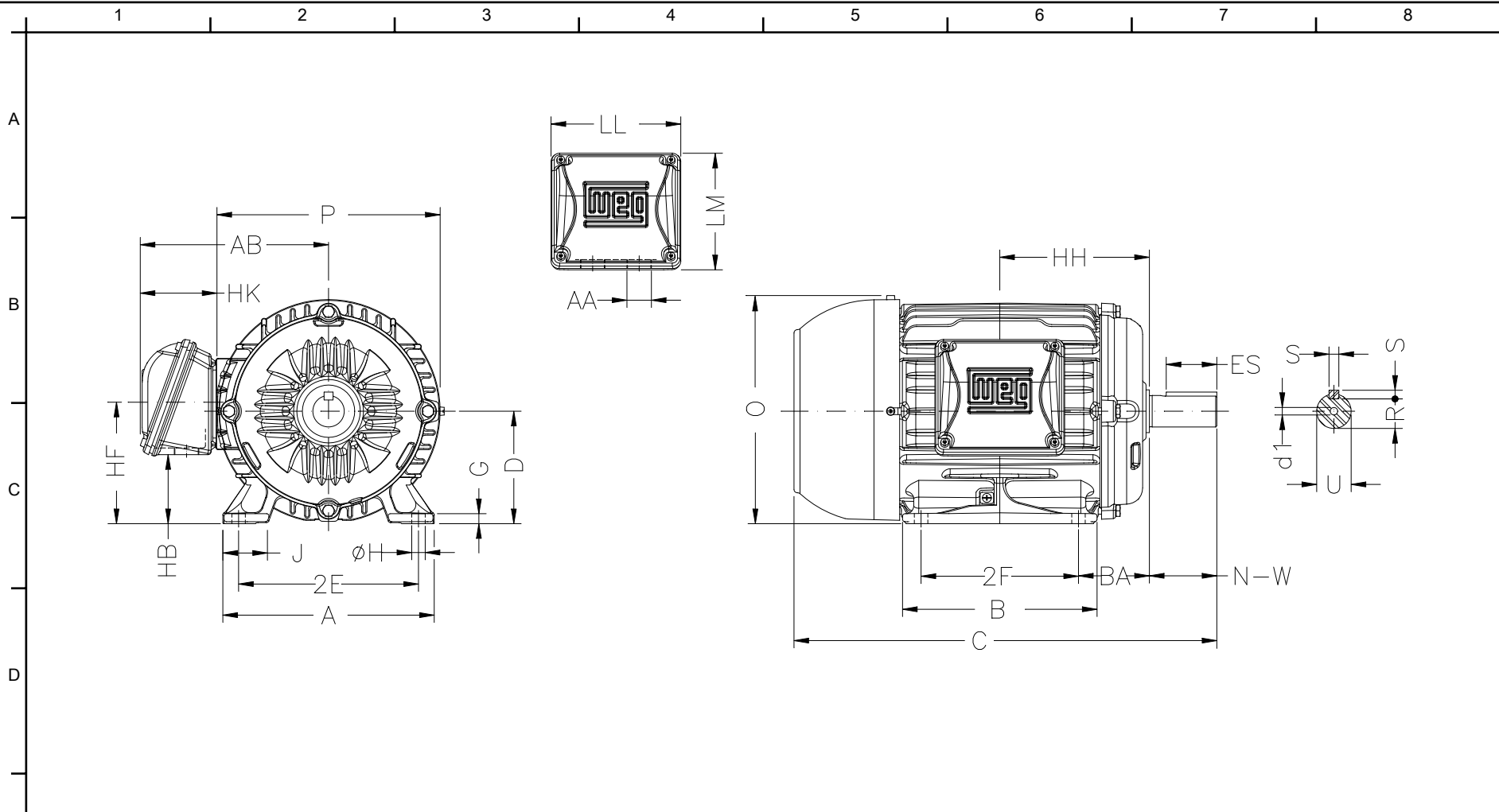

Notes:

2E 5.500	J 1.437	A 6.457	P 7.047	AB 6.181
2F 5.000	B 6.142	BA 2.250	U 0.875	N-W 2.250
ES 1.417	S 0.187	R 0.765	depth 0.187	D 3.500
G 0.354	HB 1.728	O 7.122	HF 3.500	HH 4.750
HK 2.638	H 0.344	C 13.346	LL 4.527	LM 4.094
AA NPT 3/4"	d1 A 4	d2 A 4	Flange FD-254	AJ 10.000
AK 9.000	BD 11.00	BF 0.562	BB 0.203	

Performed by:

Checked:

Customer:

Three-Phase: W22 IEEE-841™ Petrochem Motors - NEMA Premium® Efficiency

Three-phase induction motor
Frame 145T - IP55

26-DEC-2012

