



No.:

Date: 27-DEC-2012

Customer :

TECHNICAL PROPOSAL

Three-phase induction motor - Squirrel cage rotor

Product line : Three-Phase: W22 IEEE-841™ Petrochem Motors - NEMA Premium® Efficiency

Catalog Number : 00509ST3QIE254T-W22

List Price : \$4,243

Notes:

Performed by:

Checked:



No.:

Date: 27-DEC-2012

DATA SHEET

Three-phase induction motor - Squirrel cage rotor

Customer :
Product line : Three-Phase: W22 IEEE-841™ Petrochem Motors - NEMA Premium® Efficiency

Frame : 254T
Output : 5 HP
Frequency : 60 Hz
Poles : 8
Full load speed : 880
Slip : 2.22 %
Voltage : 460 V
Rated current : 7.58 A
Locked rotor current : 40.2 A
Locked rotor current (I_L/I_n) : 5.3
No-load current : 4.50 A
Full load torque : 29.4 lb.ft
Locked rotor torque : 190 %
Breakdown torque : 250 %
Design : B
Insulation class : F
Temperature rise : 80 K
Locked rotor time : 44 s (hot)
Service factor : 1.25
Duty cycle : S1
Ambient temperature : -20°C - +40°C
Altitude : 1000
Degree of Protection : IP55
Approximate weight : 258 lb
Moment of inertia : 3.4086 sq.ft.lb
Noise level : 54 dB(A)

	D.E.	N.D.E.	Load	Power factor	Efficiency (%)
Bearings	6309 C3	6209 C3	100%	0.70	87.5
Regreasing interval	20000 h	20000 h	75%	0.62	87.5
Grease amount	13 g	9 g	50%	0.49	85.5

Notes:

Performed by

Checked



No.:

Date: 27-DEC-2012

PERFORMANCE CURVES RELATED TO RATED OUTPUT

Three-phase induction motor - Squirrel cage rotor

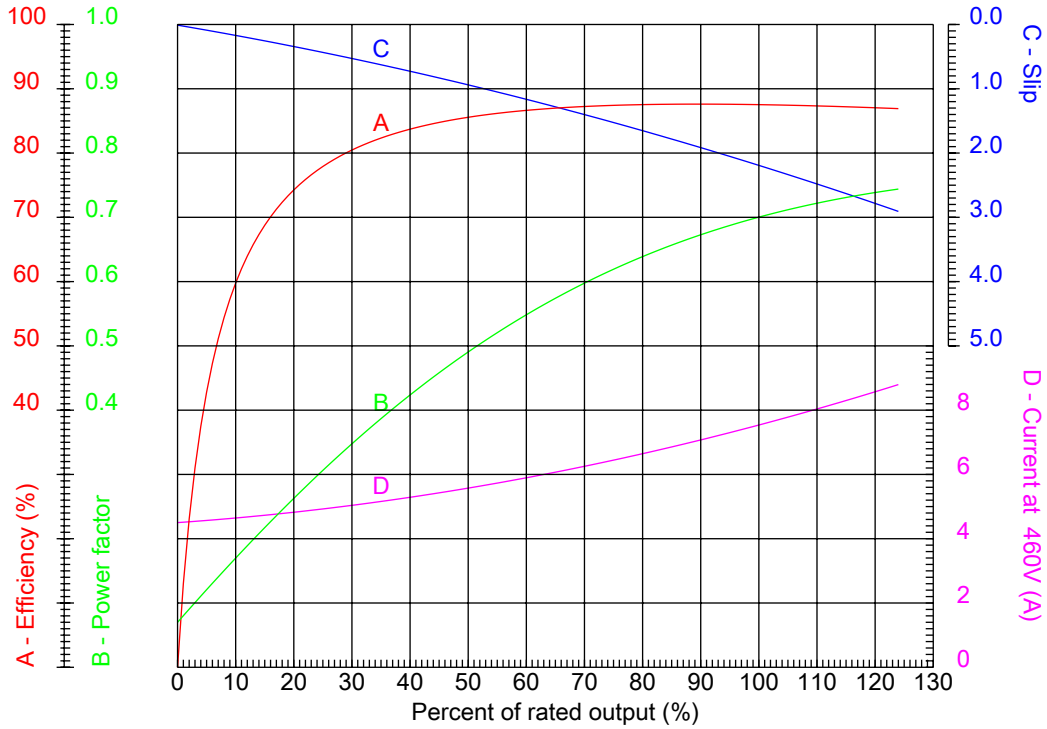

Customer :
Product line : Three-Phase: W22 IEEE-841™ Petrochem Motors - NEMA Premium® Efficiency

Frame : 254T	Locked rotor current (I _l /I _n) : 5.3
Output : 5 HP	Duty cycle : S1
Frequency : 60 Hz	Service factor : 1.25
Full load speed : 880	Design : B
Voltage : 460 V	Locked rotor torque : 190 %
Rated current : 7.58 A	Breakdown torque : 250 %
Insulation class : F	

Notes:

Performed by

Checked



No.:

Date: 27-DEC-2012

CHARACTERISTIC CURVES RELATED TO SPEED

Three-phase induction motor - Squirrel cage rotor

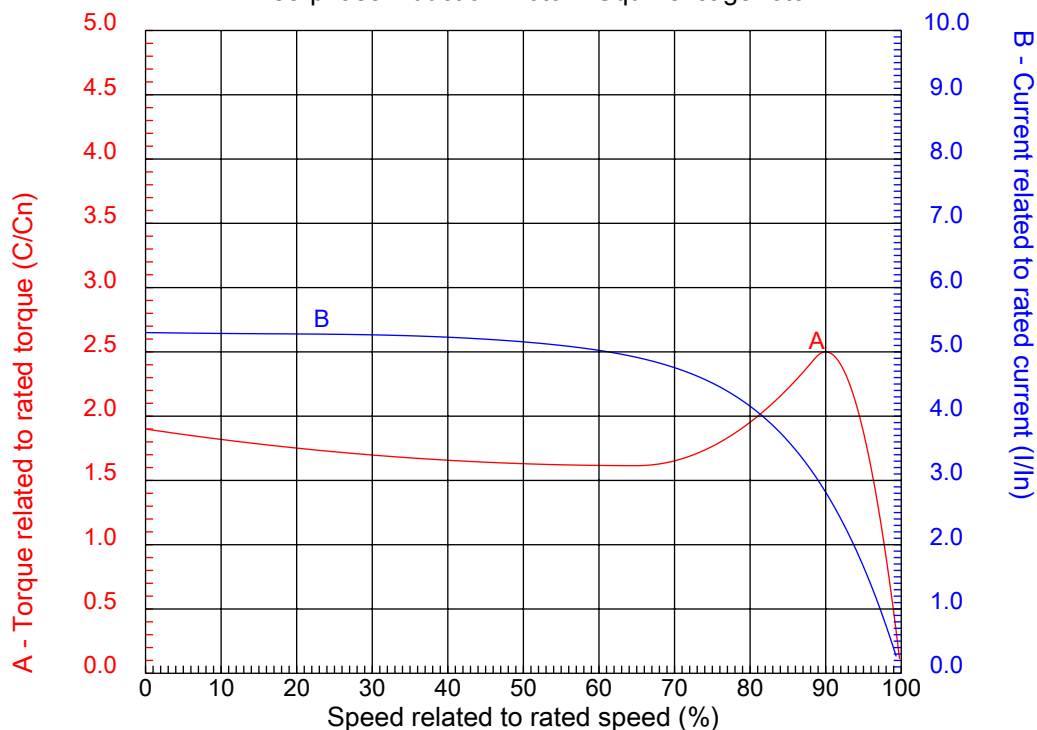

Customer :
Product line : Three-Phase: W22 IEEE-841™ Petrochem Motors - NEMA Premium® Efficiency

Frame	: 254T	Locked rotor current (I _l /I _n)	: 5.3
Output	: 5 HP	Duty cycle	: S1
Frequency	: 60 Hz	Service factor	: 1.25
Full load speed	: 880	Design	: B
Voltage	: 460 V	Locked rotor torque	: 190 %
Rated current	: 7.58 A	Breakdown torque	: 250 %
Insulation class	: F		

Notes:

Performed by

Checked

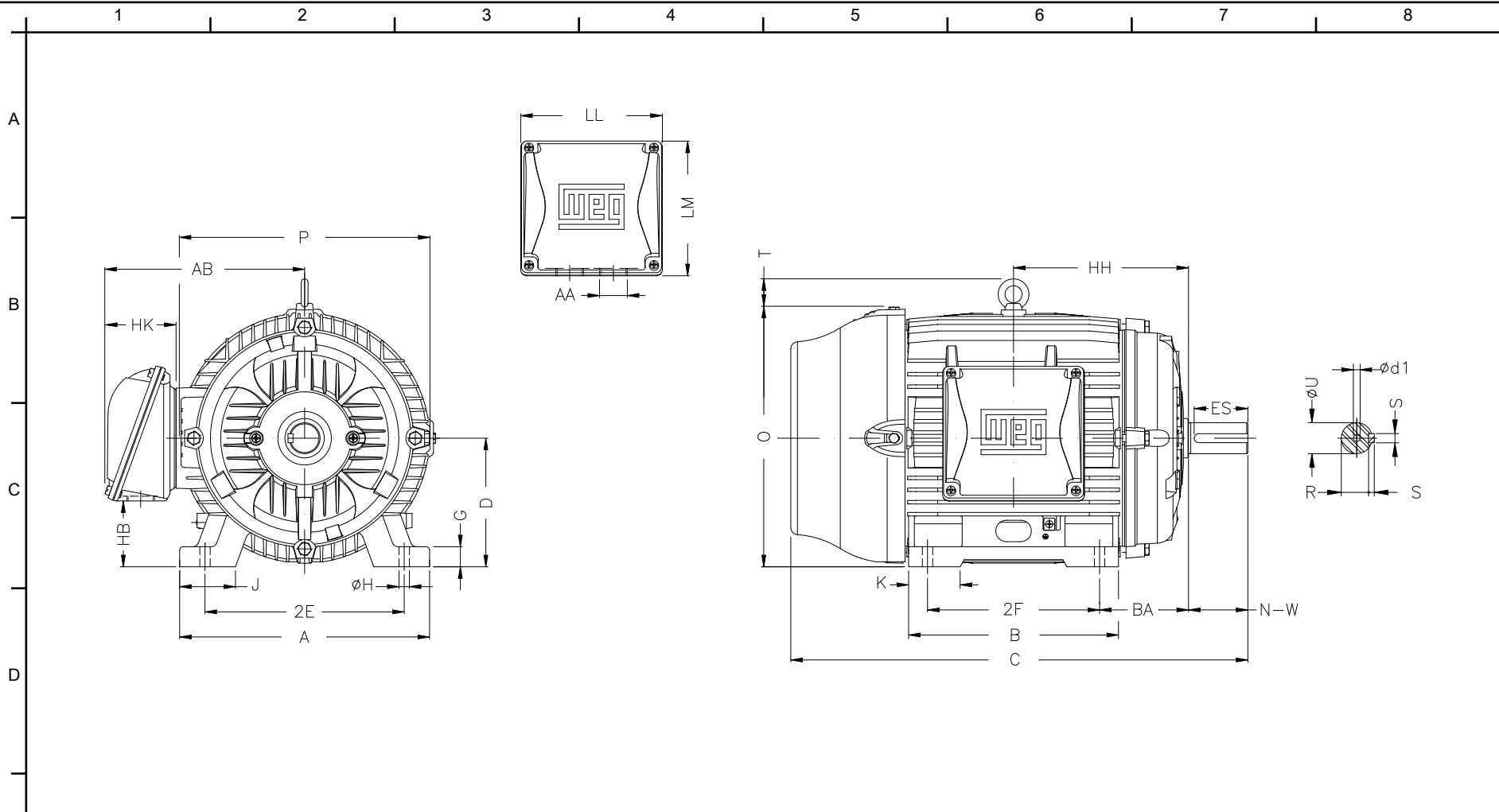

E	2E 10.000	J 2.539	A 12.126	P 12.953	AB 10.394
	2F 8.252	K 2.559	B 10.000	BA 4.250	U 1.625
	N-W 4.000	ES 2.756	S 0.375	R 1.406	depth 0.375
	D 6.250	G 0.827	HB 3.061	O 12.598	T 2.087
	HD 14.685	HF 6.565	HH 8.376	HK 3.937	H 0.531
F	C 23.213	LL 7.795	LM 7.402	AA NPT 1 1/2"	d1 A 4
	d2 A 4	Flange FD-317	AJ 12.500	AK 11.000	BD 14.00
	BF 0.828	BB 0.203			

Notes:

Performed by:

Checked:

Customer:

Three-Phase: W22 IEEE-841™ Petrochem Motors - NEMA Premium® Efficiency

Three-phase induction motor Frame 254T - IP55	27-DEC-2012	
--	-------------	--