



No.:

Date: 27-DEC-2012

Customer :

TECHNICAL PROPOSAL

Three-phase induction motor - Squirrel cage rotor

Product line : Three-Phase: W22 IEEE-841™ Petrochem Motors - NEMA Premium® Efficiency

Catalog Number : 01018ST3HIE215T-W22

List Price : \$1,760

Notes:

Performed by:

Checked:



No.:

Date: 27-DEC-2012

DATA SHEET

Three-phase induction motor - Squirrel cage rotor

Customer :
Product line : Three-Phase: W22 IEEE-841™ Petrochem Motors - NEMA Premium® Efficiency

Frame : 215T
Output : 10 HP
Frequency : 60 Hz
Poles : 4
Full load speed : 1760
Slip : 2.22 %
Voltage : 575 V
Rated current : 9.92 A
Locked rotor current : 63.5 A
Locked rotor current (I_L/I_n) : 6.4
No-load current : 4.52 A
Full load torque : 29.4 lb.ft
Locked rotor torque : 200 %
Breakdown torque : 300 %
Design : B
Insulation class : F
Temperature rise : 80 K
Locked rotor time : 17 s (hot)
Service factor : 1.25
Duty cycle : S1
Ambient temperature : -20°C - +40°C
Altitude : 1000
Degree of Protection : IP55
Approximate weight : 172 lb
Moment of inertia : 1.5104 sq.ft.lb
Noise level : 58 dB(A)

	D.E.	N.D.E.	Load	Power factor	Efficiency (%)
Bearings	6308 C3	6207 C3	100%	0.83	91.7
Regreasing interval	20000 h	20000 h	75%	0.77	91.7
Grease amount	11 g	7 g	50%	0.66	90.2

Notes:

Performed by

Checked



No.:

Date: 27-DEC-2012

PERFORMANCE CURVES RELATED TO RATED OUTPUT Three-phase induction motor - Squirrel cage rotor

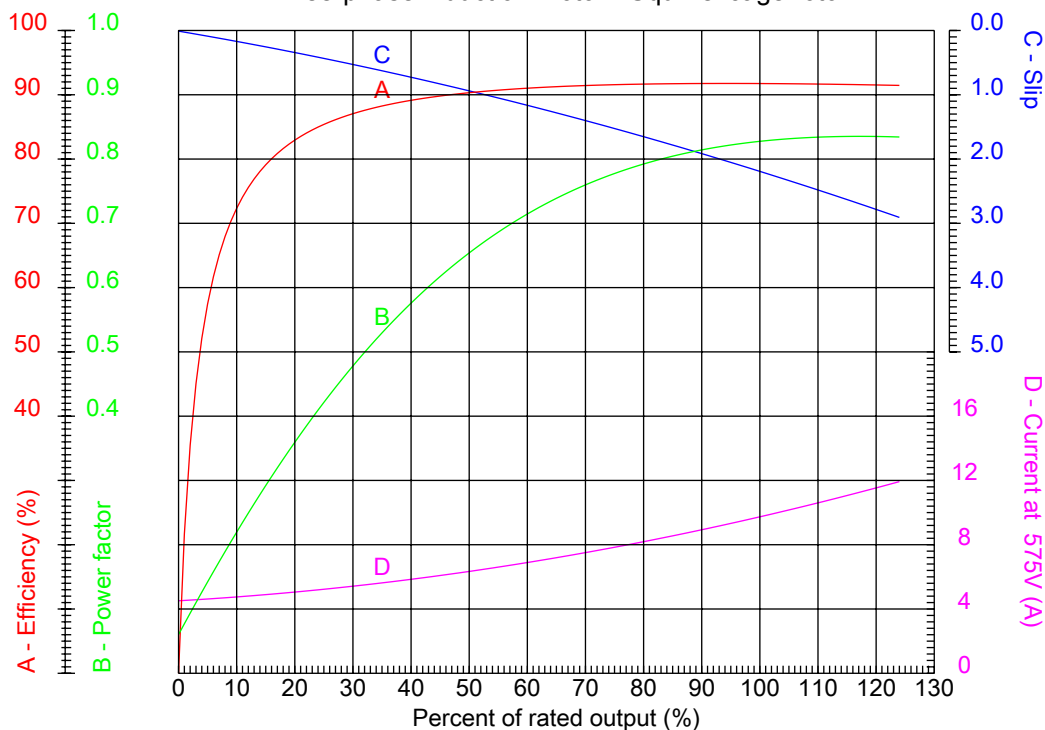

Customer :
Product line : Three-Phase: W22 IEEE-841™ Petrochem Motors - NEMA Premium® Efficiency

Frame : 215T	Locked rotor current (I _l /I _n) : 6.4
Output : 10 HP	Duty cycle : S1
Frequency : 60 Hz	Service factor : 1.25
Full load speed : 1760	Design : B
Voltage : 575 V	Locked rotor torque : 200 %
Rated current : 9.92 A	Breakdown torque : 300 %
Insulation class : F	

Notes:

Performed by

Checked



No.:

Date: 27-DEC-2012

CHARACTERISTIC CURVES RELATED TO SPEED Three-phase induction motor - Squirrel cage rotor

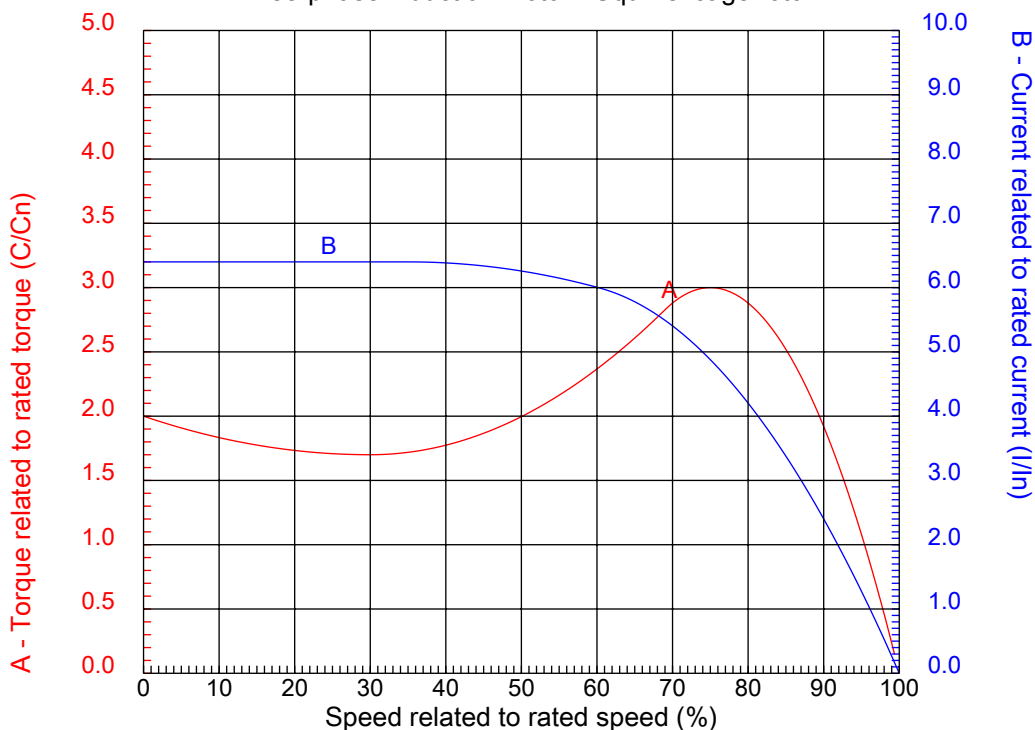

Customer :
Product line : Three-Phase: W22 IEEE-841™ Petrochem Motors - NEMA Premium® Efficiency

Frame	: 215T	Locked rotor current (I _l /I _n)	: 6.4
Output	: 10 HP	Duty cycle	: S1
Frequency	: 60 Hz	Service factor	: 1.25
Full load speed	: 1760	Design	: B
Voltage	: 575 V	Locked rotor torque	: 200 %
Rated current	: 9.92 A	Breakdown torque	: 300 %
Insulation class	: F		

Notes:

Performed by

Checked

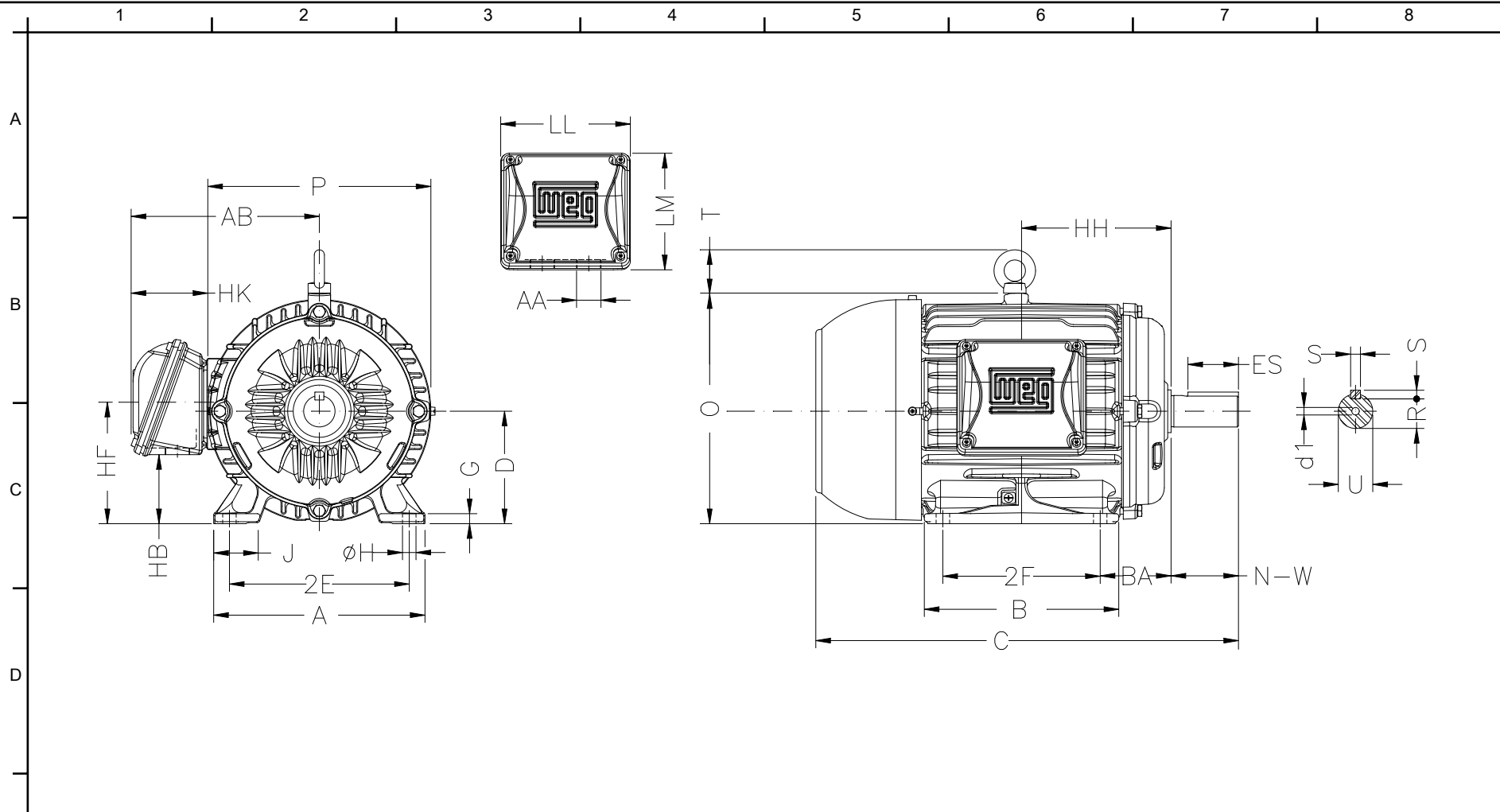

E	2E 8.500	J 1.988	A 9.764	P 10.669	AB 8.583
	2F 7.000	K 2.165	B 8.858	BA 3.500	U 1.375
	N-W 3.375	ES 2.756	S 0.313	R 1.203	depth 0.313
	D 5.250	G 0.827	HB 3.006	O 10.841	T 1.772
	HD 12.613	HF 5.250	HH 7.000	HK 3.110	H 0.406
F	C 19.517	LL 5.512	LM 5.236	AA NPT 1"	d1 A 4
	d2 A 4	Flange FD-254	AJ 10.000	AK 9.000	BD 11.00
	BF 0.562	BB 0.203			

Notes:

Performed by:

Checked:

Customer:

Three-Phase: W22 IEEE-841™ Petrochem Motors - NEMA Premium® Efficiency

Three-phase induction motor Frame 215T - IP55	27-DEC-2012	
--	-------------	--