



No.:

Date: 27-DEC-2012

Customer :

TECHNICAL PROPOSAL

Three-phase induction motor - Squirrel cage rotor

Product line : Close Coupled Pump: Three-Phase - W22 "JM" Type - TEFC - NEMA Premium

Catalog Number : 01536ET3E254JM-W22

List Price : \$2,214

Notes:

Performed by:

Checked:



No.:

Date: 27-DEC-2012

DATA SHEET

Three-phase induction motor - Squirrel cage rotor

Customer :
Product line : Close Coupled Pump: Three-Phase - W22 "JM" Type - TEFC - NEMA Premium

Frame : 254JM
Output : 15 HP
Frequency : 60 Hz
Poles : 2
Full load speed : 3530
Slip : 1.94 %
Voltage : 208-230/460 V
Rated current : 37.6-34.4/17.2 A
Locked rotor current : 234/117 A
Locked rotor current (I_L/I_n) : 6.8
No-load current : 12.0/6.00 A
Full load torque : 22.0 lb.ft
Locked rotor torque : 220 %
Breakdown torque : 270 %
Design : B
Insulation class : F
Temperature rise : 80 K
Locked rotor time : 25 s (hot)
Service factor : 1.25
Duty cycle : S1
Ambient temperature : -20°C - +40°C
Altitude : 1000
Degree of Protection : IP55
Approximate weight : 236 lb
Moment of inertia : 1.2565 sq.ft.lb
Noise level : 72 dB(A)

	D.E.	N.D.E.	Load	Power factor	Efficiency (%)
Bearings	6309 C3	6209 C3	100%	0.88	91.0
Regreasing interval	19000 h	20000 h	75%	0.85	91.0
Grease amount	13 g	9 g	50%	0.77	89.5

Notes:

Performed by

Checked



No.:

Date: 27-DEC-2012

PERFORMANCE CURVES RELATED TO RATED OUTPUT

Three-phase induction motor - Squirrel cage rotor

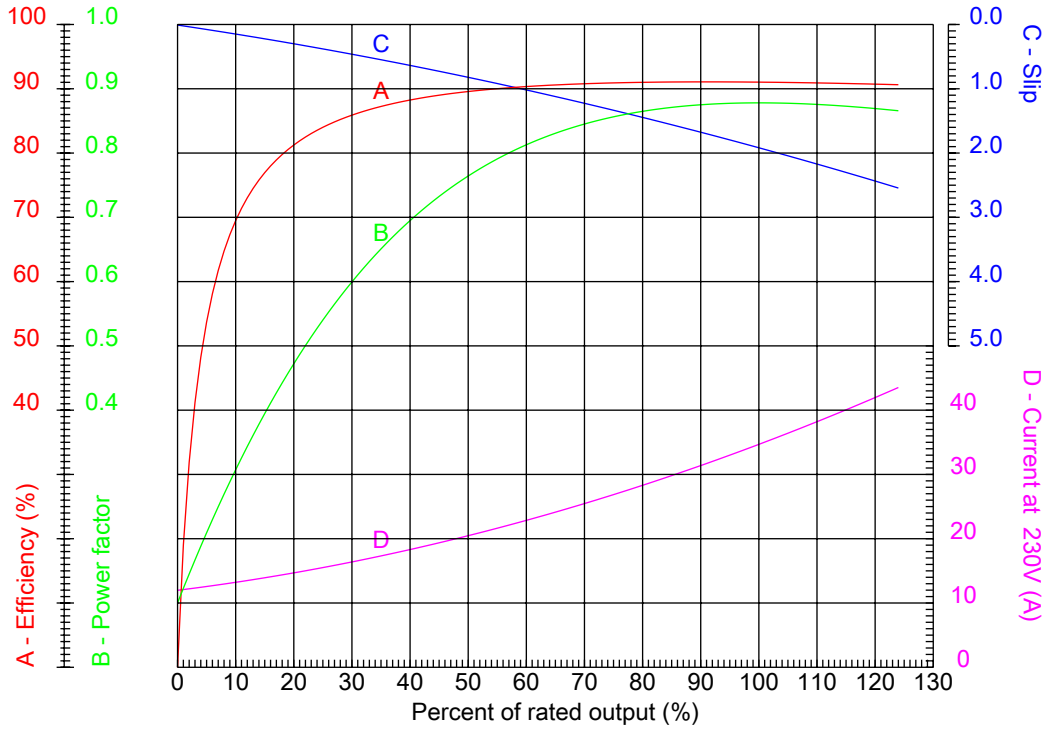

Customer :
 Product line : Close Coupled Pump: Three-Phase - W22 "JM" Type - TEFC - NEMA Premium

Frame	: 254JM	Locked rotor current (I _l /I _n)	: 6.8
Output	: 15 HP	Duty cycle	: S1
Frequency	: 60 Hz	Service factor	: 1.25
Full load speed	: 3530	Design	: B
Voltage	: 208-230/460 V	Locked rotor torque	: 220 %
Rated current	: 37.6-34.4/17.2 A	Breakdown torque	: 270 %
Insulation class	: F		

Notes:

Performed by

Checked



No.:

Date: 27-DEC-2012

CHARACTERISTIC CURVES RELATED TO SPEED Three-phase induction motor - Squirrel cage rotor

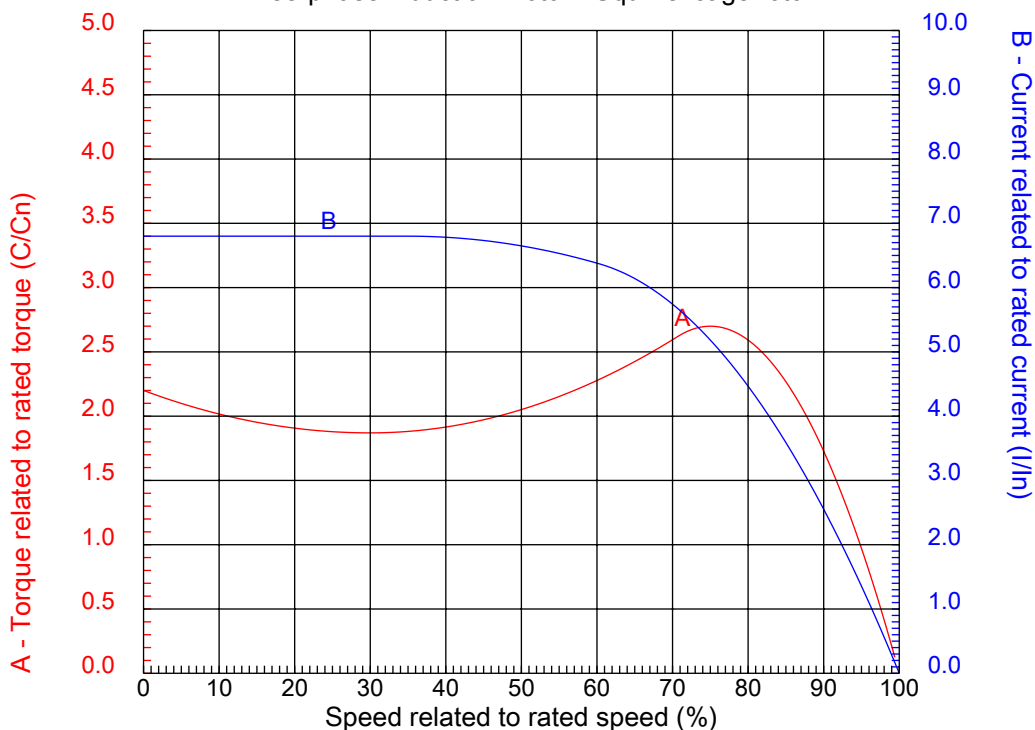

Customer :
Product line : Close Coupled Pump: Three-Phase - W22 "JM" Type - TEFC - NEMA Premium

Frame	: 254JM	Locked rotor current (I _l /I _n)	: 6.8
Output	: 15 HP	Duty cycle	: S1
Frequency	: 60 Hz	Service factor	: 1.25
Full load speed	: 3530	Design	: B
Voltage	: 208-230/460 V	Locked rotor torque	: 220 %
Rated current	: 37.6-34.4/17.2 A	Breakdown torque	: 270 %
Insulation class	: F		

Notes:

Performed by

Checked

1 2 3 4 5 6 7 8

A

B

C

D

E

F

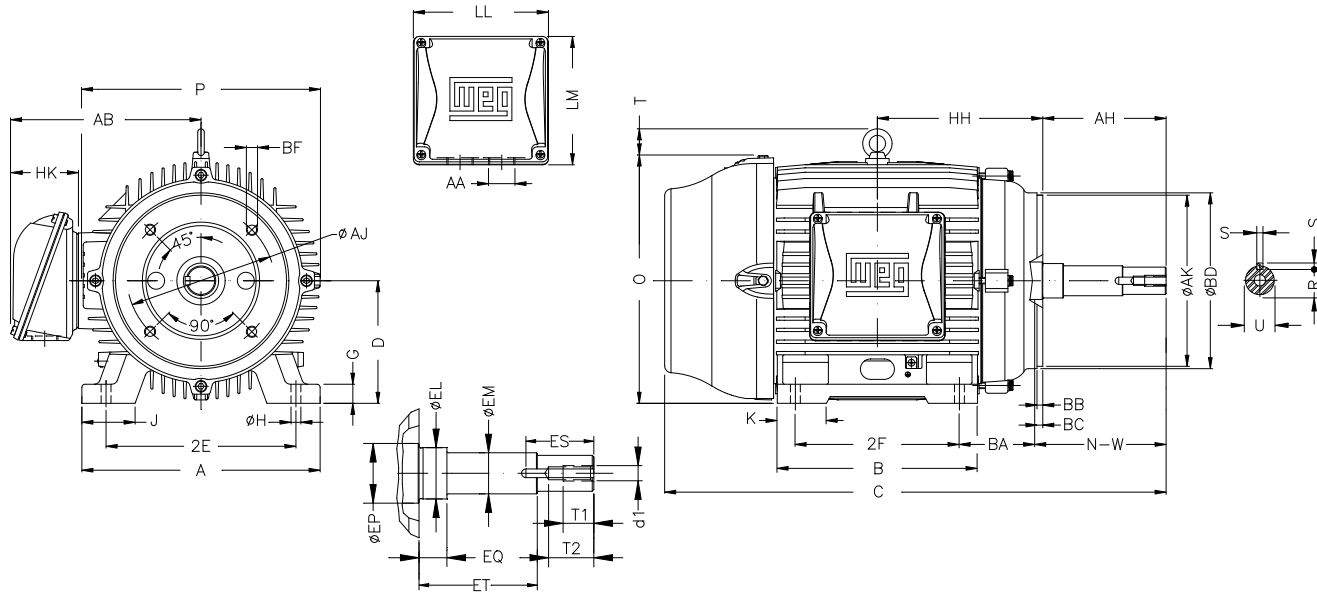

Notes:

Performed by:

Checked:

Customer:

Close Coupled Pump: Three-Phase - W22 "JM" Type - TEFC - NEMA Premium

Three-phase induction motor
Frame 254JM - IP55

27-DEC-2012



2E 10.000	J 2.539	A 12.126	P 12.953	AB 10.394
2F 8.252	K 2.559	B 10.000	BA 4.250	D 6.250
G 0.827	O 12.598	T 2.087	HD 14.685	H 0.531
AA NPT 1 1/2"	ER 5.250	EQ 0.630	ET 3.006	U 1.249
EM 1.375	EL 1.750	EP 1.750	ES 2.480	t1 0.984
t2 1.496	C 24.370	Flange FC-184	AJ 7.252	AK 8.500
BD 8.858	BF UNC 1/2"x13	BB 0.248	BC ---	AH 5.250