



No.:

Date: 27-DEC-2012

Customer :

TECHNICAL PROPOSAL

Three-phase induction motor - Squirrel cage rotor

Product line : Three-Phase: W22 IEEE-841™ Petrochem Motors - NEMA Premium® Efficiency

Catalog Number : 02009ST3QIE324T-W22

List Price : \$8,269

Notes:

Performed by:

Checked:



No.:

Date: 27-DEC-2012

DATA SHEET

Three-phase induction motor - Squirrel cage rotor

Customer :
Product line : Three-Phase: W22 IEEE-841™ Petrochem Motors - NEMA Premium® Efficiency

Frame : 324T
Output : 20 HP
Frequency : 60 Hz
Poles : 8
Full load speed : 880
Slip : 2.22 %
Voltage : 460 V
Rated current : 28.3 A
Locked rotor current : 142 A
Locked rotor current (I_L/I_n) : 5.0
No-load current : 16.0 A
Full load torque : 118 lb.ft
Locked rotor torque : 190 %
Breakdown torque : 220 %
Design : B
Insulation class : F
Temperature rise : 80 K
Locked rotor time : 27 s (hot)
Service factor : 1.25
Duty cycle : S1
Ambient temperature : -20°C - +40°C
Altitude : 1000
Degree of Protection : IP55
Approximate weight : 452 lb
Moment of inertia : 9.3650 sq.ft.lb
Noise level : 56 dB(A)

	D.E.	N.D.E.	Load	Power factor	Efficiency (%)
Bearings	6312 C3	6212 C3	100%	0.73	91.0
Regreasing interval	20000 h	20000 h	75%	0.66	91.0
Grease amount	21 g	13 g	50%	0.54	89.5

Notes:

Performed by

Checked



No.:

Date: 27-DEC-2012

PERFORMANCE CURVES RELATED TO RATED OUTPUT

Three-phase induction motor - Squirrel cage rotor

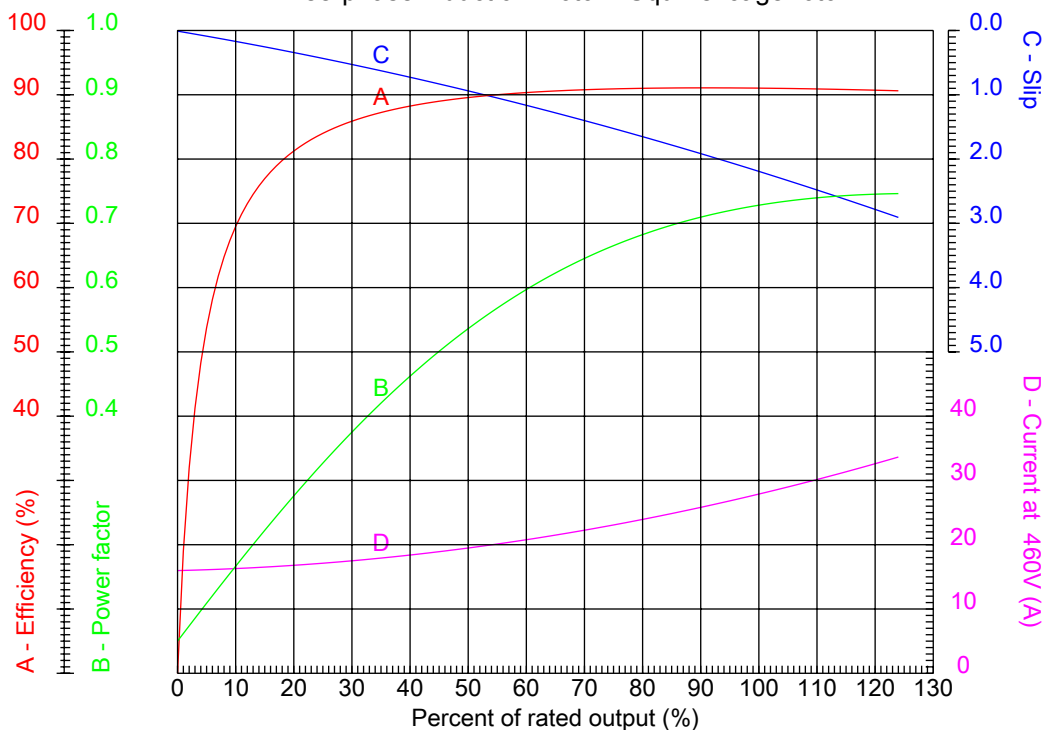

Customer :
Product line : Three-Phase: W22 IEEE-841™ Petrochem Motors - NEMA Premium® Efficiency

Frame : 324T	Locked rotor current (I _L /I _n) : 5.0
Output : 20 HP	Duty cycle : S1
Frequency : 60 Hz	Service factor : 1.25
Full load speed : 880	Design : B
Voltage : 460 V	Locked rotor torque : 190 %
Rated current : 28.3 A	Breakdown torque : 220 %
Insulation class : F	

Notes:

Performed by

Checked



No.:

Date: 27-DEC-2012

CHARACTERISTIC CURVES RELATED TO SPEED

Three-phase induction motor - Squirrel cage rotor

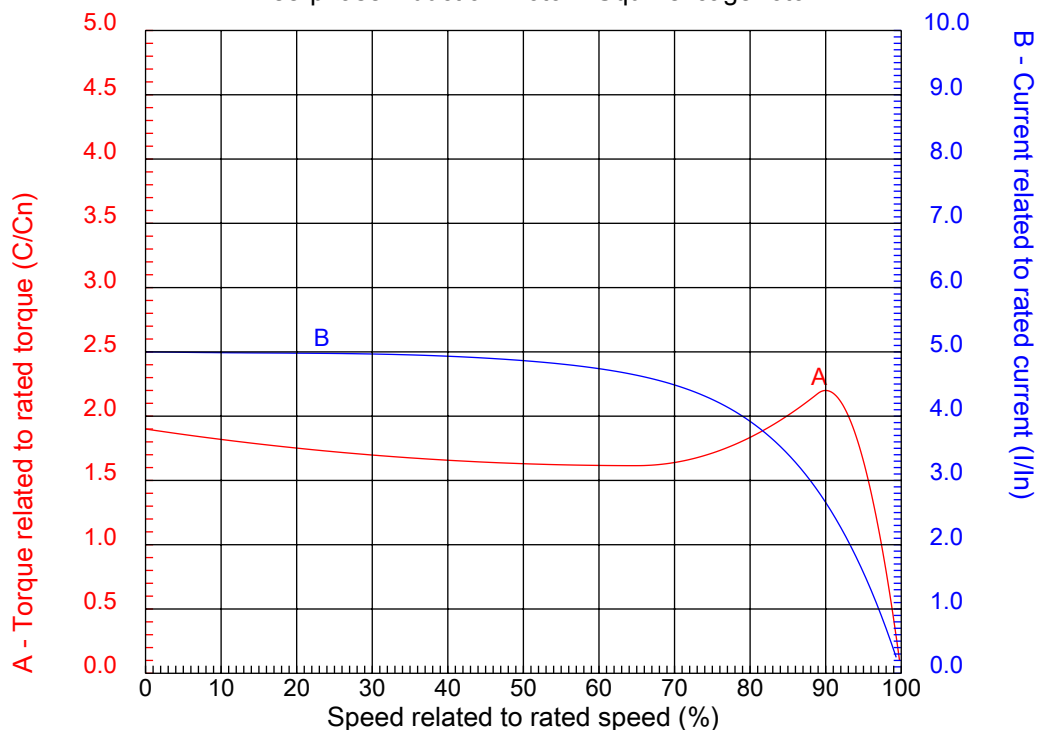

Customer :
Product line : Three-Phase: W22 IEEE-841™ Petrochem Motors - NEMA Premium® Efficiency

Frame	: 324T	Locked rotor current (I _l /I _n)	: 5.0
Output	: 20 HP	Duty cycle	: S1
Frequency	: 60 Hz	Service factor	: 1.25
Full load speed	: 880	Design	: B
Voltage	: 460 V	Locked rotor torque	: 190 %
Rated current	: 28.3 A	Breakdown torque	: 220 %
Insulation class	: F		

Notes:

Performed by

Checked

1 2 3 4 5 6 7 8

A
B
C
D
E
F

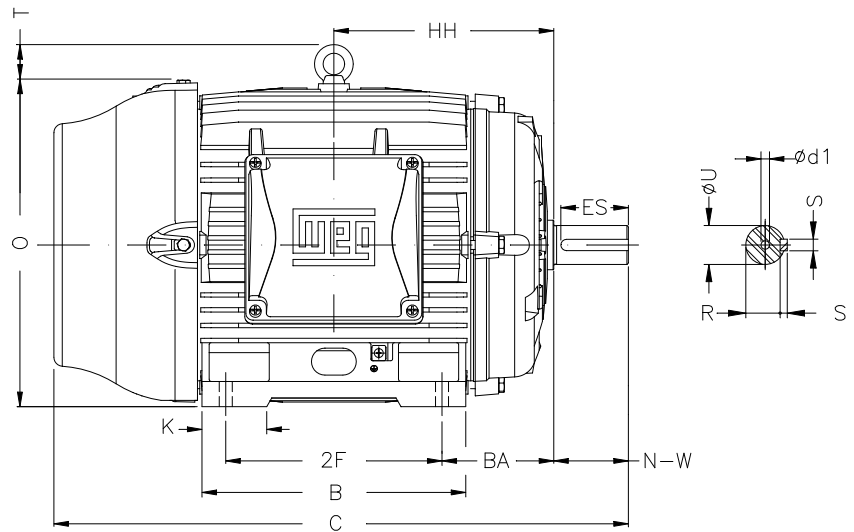
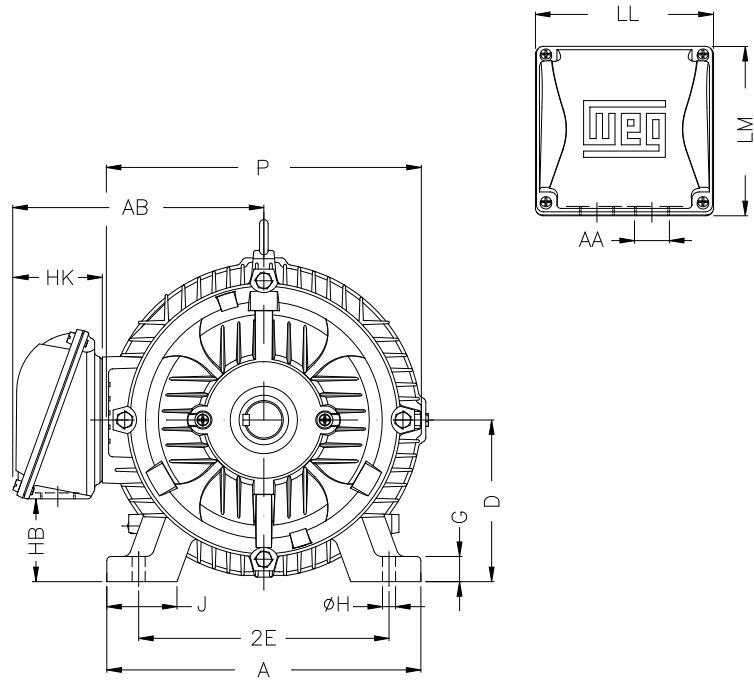

2E	J	A	P	AB
12.500	3.189	15.157	15.827	12.480
2F	K	B	BA	U
10.500	3.189	13.071	5.250	2.125
N-W	ES	S	R	depth
5.250	3.937	0.500	1.844	0.500
D	G	HB	O	T
8.000	1.300	4.811	15.953	2.441
HD	HF	HH	HK	H
18.394	8.708	10.500	4.645	0.657
C	LL	LM	AA	d1
29.620	8.976	8.543	NPT 2"	A 4
d2	Flange	AJ	AK	BD
A 4	FD-406	16.000	14.000	18.00
BF	BB			
0.828	0.203			

Notes:

Performed by:

Checked:

Customer:

Three-Phase: W22 IEEE-841™ Petrochem Motors - NEMA Premium® Efficiency

Three-phase induction motor
Frame 324T - IP55

27-DEC-2012

