



No.:

Date: 27-DEC-2012

Customer :

TECHNICAL PROPOSAL

Three-phase induction motor - Squirrel cage rotor

Product line : Close Coupled Pump : Three-Phase - "JM" Type - ODP - NEMA Premium

Catalog Number : 02018OT3E256JM

List Price : \$2,413

Notes:

Performed by:

Checked:



No.:

Date: 27-DEC-2012

DATA SHEET

Three-phase induction motor - Squirrel cage rotor

Customer :
Product line : Close Coupled Pump : Three-Phase - "JM" Type - ODP - NEMA Premium

Frame : 256JM
Output : 20 HP
Frequency : 60 Hz
Poles : 4
Full load speed : 1770
Slip : 1.67 %
Voltage : 208-230/460 V
Rated current : 55.3-49.4/24.7 A
Locked rotor current : 311/156 A
Locked rotor current (I_L/I_n) : 6.3
No-load current : 24.0/12.0 A
Full load torque : 58.5 lb.ft
Locked rotor torque : 260 %
Breakdown torque : 280 %
Design : B
Insulation class : F
Temperature rise : 80 K
Locked rotor time : 12 s (hot)
Service factor : 1.15
Duty cycle : S1
Ambient temperature : -20°C - +40°C
Altitude : 1000
Degree of Protection : IP23
Approximate weight : 295 lb
Moment of inertia : 2.6198 sq.ft.lb
Noise level : 60 dB(A)

	D.E.	N.D.E.	Load	Power factor	Efficiency (%)
Bearings	6309 Z-C3	6209 Z-C3	100%	0.82	93.0
Regreasing interval	20000 h	20000 h	75%	0.72	93.0
Grease amount	13 g	9 g	50%	0.63	91.7

Notes:

Performed by

Checked



No.:

Date: 27-DEC-2012

PERFORMANCE CURVES RELATED TO RATED OUTPUT

Three-phase induction motor - Squirrel cage rotor

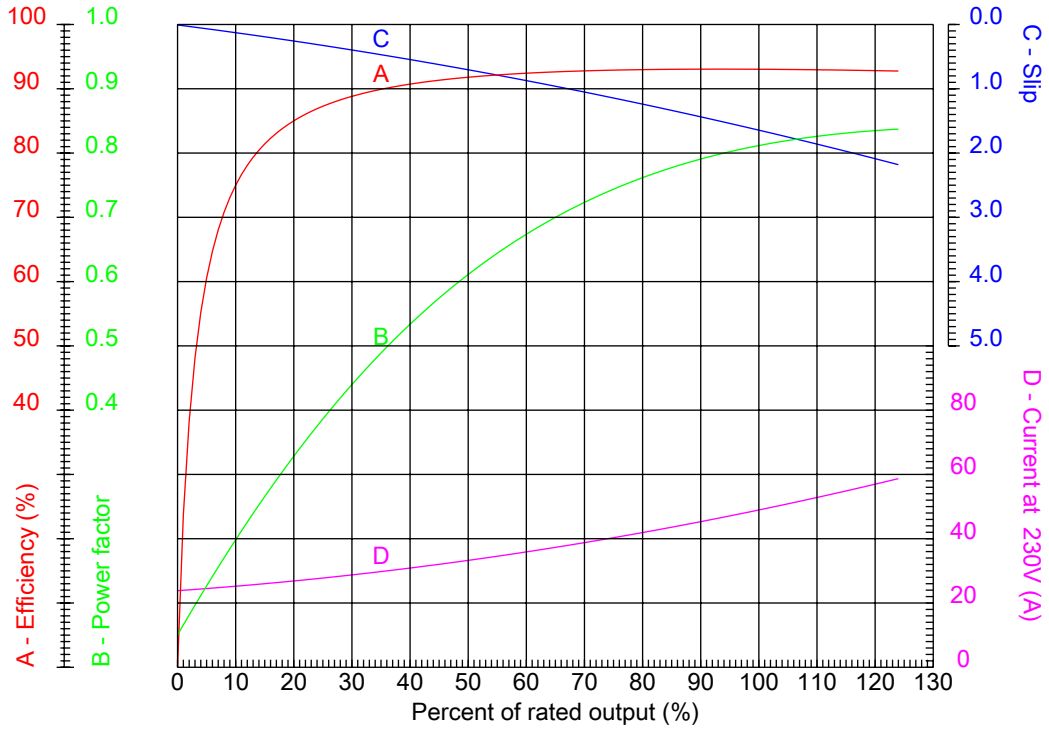

Customer :
 Product line : Close Coupled Pump : Three-Phase - "JM" Type - ODP - NEMA Premium

Frame	: 256JM	Locked rotor current (I _l /I _n)	: 6.3
Output	: 20 HP	Duty cycle	: S1
Frequency	: 60 Hz	Service factor	: 1.15
Full load speed	: 1770	Design	: B
Voltage	: 208-230/460 V	Locked rotor torque	: 260 %
Rated current	: 55.3-49.4/24.7 A	Breakdown torque	: 280 %
Insulation class	: F		

Notes:

Performed by

Checked



No.:

Date: 27-DEC-2012

CHARACTERISTIC CURVES RELATED TO SPEED

Three-phase induction motor - Squirrel cage rotor

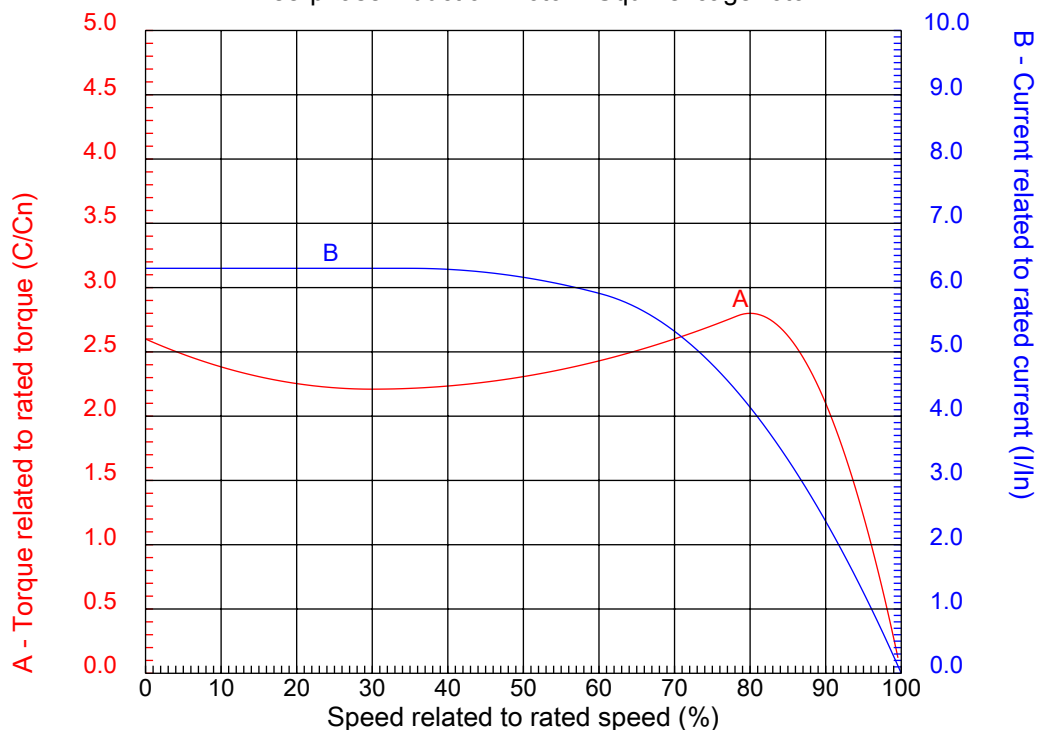

Customer :
Product line : Close Coupled Pump : Three-Phase - "JM" Type - ODP - NEMA Premium

Frame	: 256JM	Locked rotor current (I _l /I _n)	: 6.3
Output	: 20 HP	Duty cycle	: S1
Frequency	: 60 Hz	Service factor	: 1.15
Full load speed	: 1770	Design	: B
Voltage	: 208-230/460 V	Locked rotor torque	: 260 %
Rated current	: 55.3-49.4/24.7 A	Breakdown torque	: 280 %
Insulation class	: F		

Notes:

Performed by

Checked

1 2 3 4 5 6 7 8

A

B

C

D

E

F

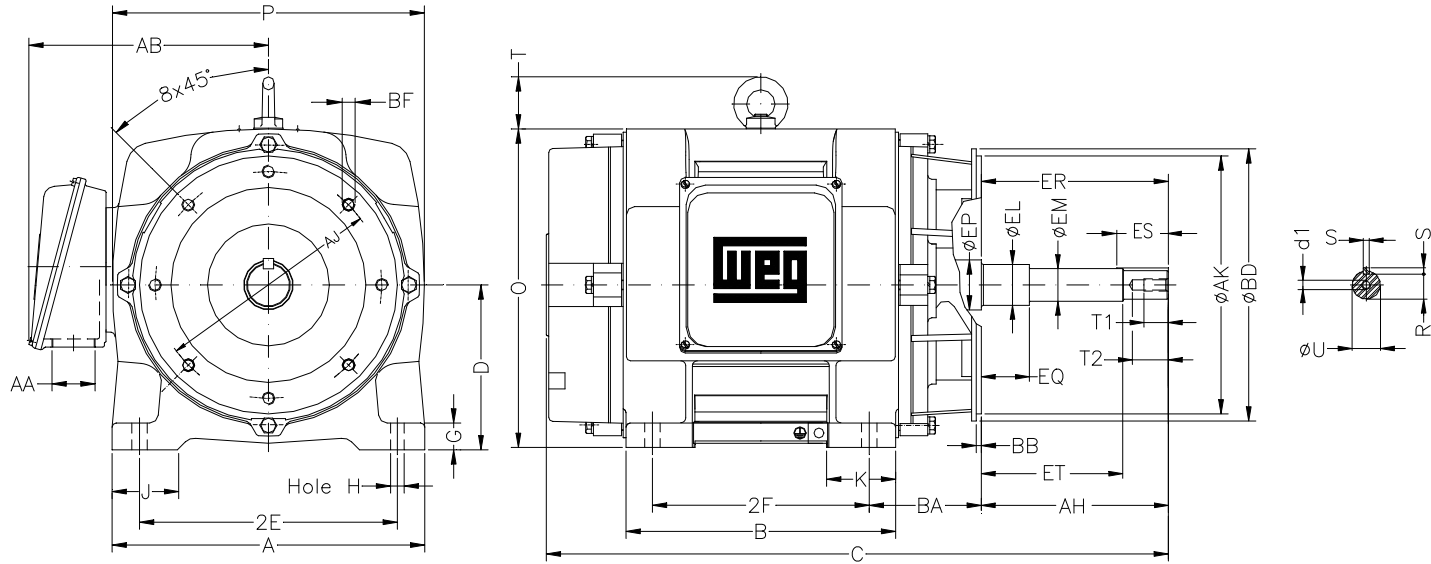

Notes:

2E	A	2F	B	J
10.000	12.130	10.000	11.732	2.520
BA	D	K	G	O
4.500	6.220	2.560	0.787	12.204
P	T	HD	H	AA
11.812	2.165	14.369	0.531	NPT 1 1/2"
ER	EQ	ET	U	EM
5.250	0.630	3.006	1.249	1.375
EL	S	EP	R	ES
1.750	0.250	1.750	1.110	2.559
d1	t1	t2	C	Flange
EUNC 1/2"-13	0.984	1.496	23.902	FC-184
AJ	AK	BD	BF	BB
7.250	8.500	8.858	UNC 1/2"x13	0.250
BC	AH			
	5.250			

Performed by:

Checked:

Customer:

Close Coupled Pump : Three-Phase - "JM" Type - ODP - NEMA Premium

Three-phase induction motor
Frame 256JM - IP23

27-DEC-2012

