



No.:

Date: 27-DEC-2012

Customer :

TECHNICAL PROPOSAL

Three-phase induction motor - Squirrel cage rotor

Product line : Oil Well Pumping : High Slip - NEMA Design "D" - TEFC (IP55)

Catalog Number : 02512ES3EOW324T

List Price : \$3,887

Notes:

Performed by:

Checked:



No.:

Date: 27-DEC-2012

DATA SHEET

Three-phase induction motor - Squirrel cage rotor

Customer :
Product line : Oil Well Pumping : High Slip - NEMA Design "D" - TEFC (IP55)

Frame : 324T
Output : 25 HP
Frequency : 60 Hz
Poles : 6
Full load speed : 1135
Slip : 5.42 %
Voltage : 208-230/460 V
Rated current : 65.9-59.6/29.8 A
Locked rotor current : 405/203 A
Locked rotor current (I_L/I_n) : 6.8
No-load current : 21.0/10.5 A
Full load torque : 114 lb.ft
Locked rotor torque : 320 %
Breakdown torque : 0 %
Design : D
Insulation class : F
Temperature rise : 80 K
Locked rotor time : 16 s (hot)
Service factor : 1.15
Duty cycle : S1
Ambient temperature : -20°C - +40°C
Altitude : 1000
Degree of Protection : IP55
Approximate weight : 523 lb
Moment of inertia : 10.642 sq.ft.lb
Noise level : 62 dB(A)

	D.E.	N.D.E.	Load	Power factor	Efficiency (%)
Bearings	6312 C3	6212 C3	100%	0.88	88.5
Regreasing interval	20000 h	20000 h	75%	0.83	88.0
Grease amount	21 g	13 g	50%	0.75	85.0

Notes:

Performed by

Checked



No.:

Date: 27-DEC-2012

PERFORMANCE CURVES RELATED TO RATED OUTPUT

Three-phase induction motor - Squirrel cage rotor

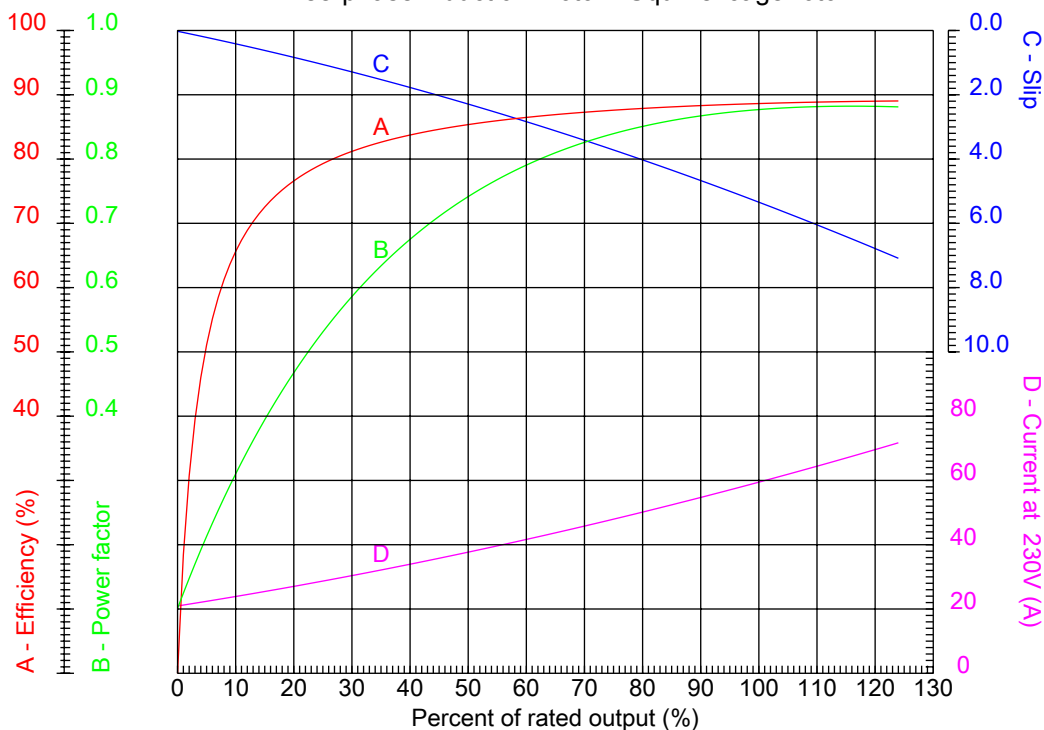

Customer :
Product line : Oil Well Pumping : High Slip - NEMA Design "D" - TEFC (IP55)

Frame : 324T	Locked rotor current (I _l /I _n) : 6.8
Output : 25 HP	Duty cycle : S1
Frequency : 60 Hz	Service factor : 1.15
Full load speed : 1135	Design : D
Voltage : 208-230/460 V	Locked rotor torque : 320 %
Rated current : 65.9-59.6/29.8 A	Breakdown torque : 0 %
Insulation class : F	

Notes:

Performed by

Checked



No.:

Date: 27-DEC-2012

CHARACTERISTIC CURVES RELATED TO SPEED

Three-phase induction motor - Squirrel cage rotor

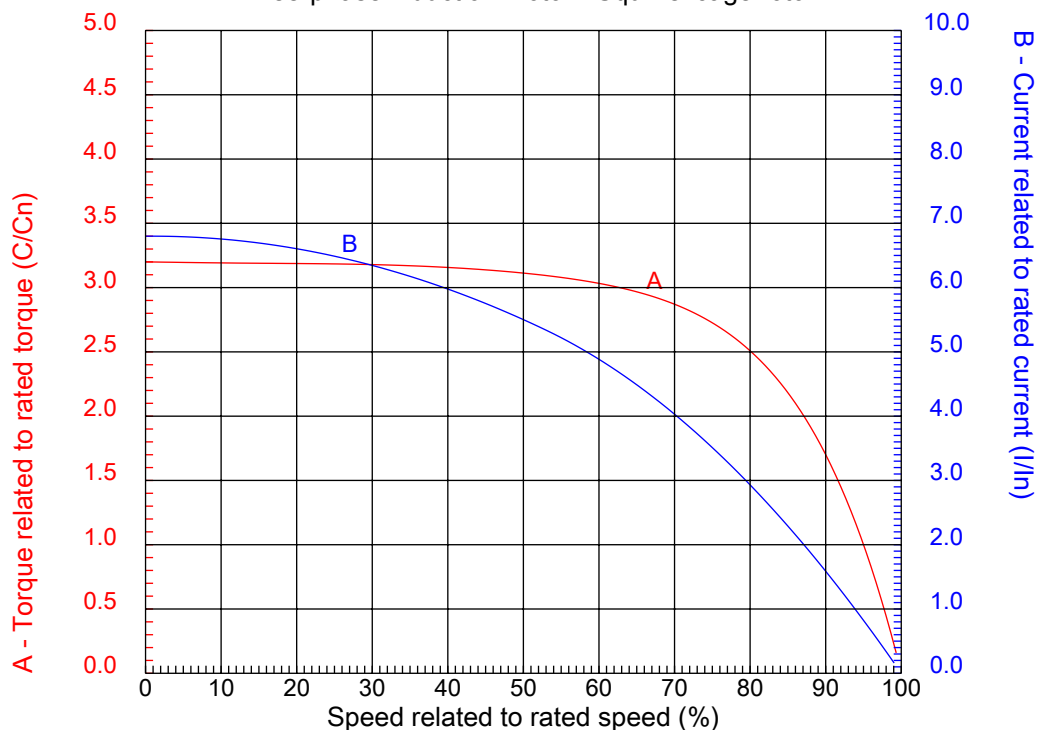

Customer :
Product line : Oil Well Pumping : High Slip - NEMA Design "D" - TEFC (IP55)

Frame	: 324T	Locked rotor current (I _l /I _n)	: 6.8
Output	: 25 HP	Duty cycle	: S1
Frequency	: 60 Hz	Service factor	: 1.15
Full load speed	: 1135	Design	: D
Voltage	: 208-230/460 V	Locked rotor torque	: 320 %
Rated current	: 65.9-59.6/29.8 A	Breakdown torque	: 0 %
Insulation class	: F		

Notes:

Performed by

Checked

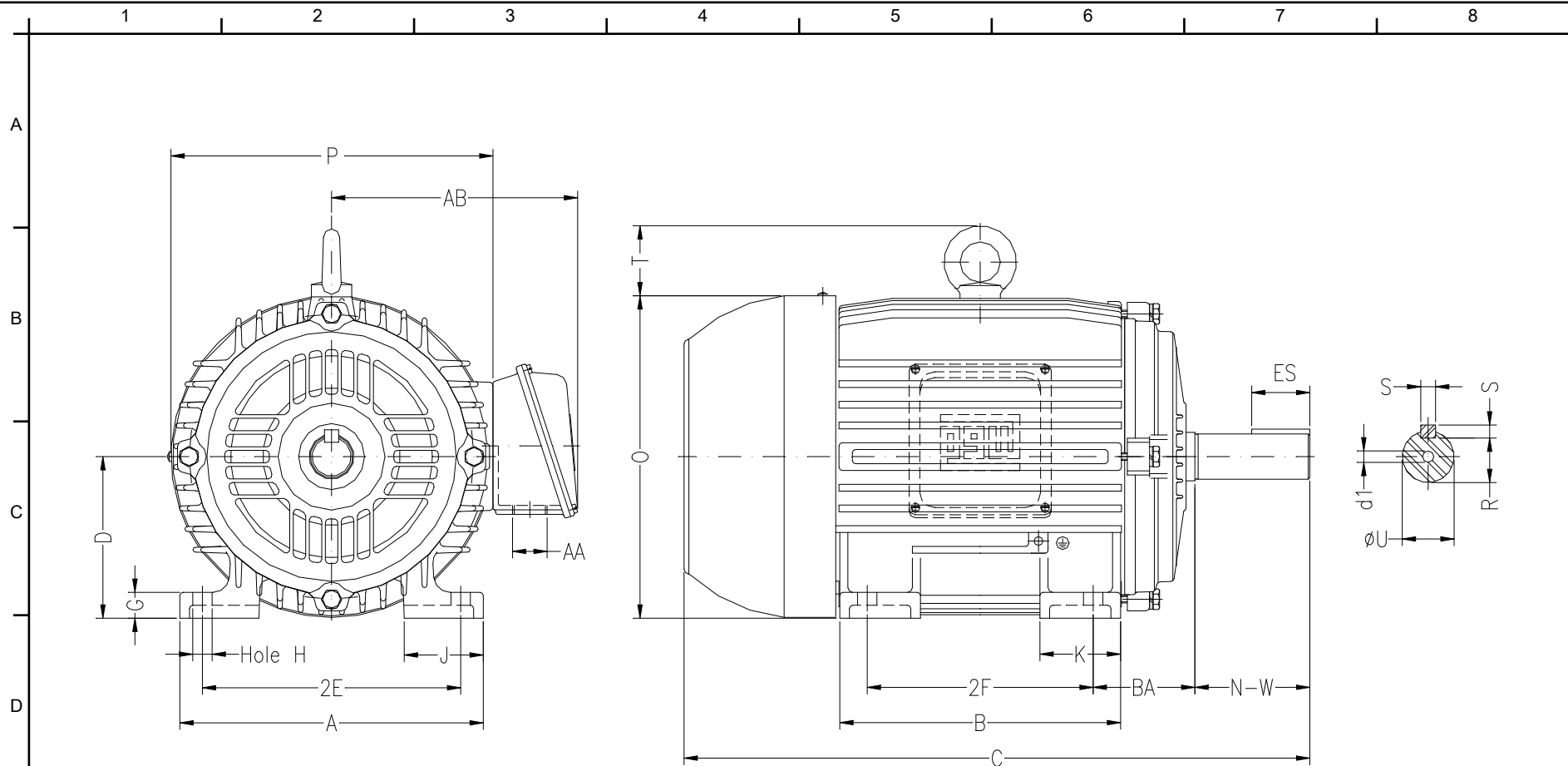

Notes:

2E 12.500	A 15.157	2F 10.500	B 13.071	BA 5.250
J 3.228	K 3.346	P 15.591	ES 3.937	depth 0.500
S 0.500	N-W 5.250	U 2.125	R 1.844	AB 11.496
D 8.000	G 1.307	O 15.953	T 2.441	HD 18.394
H 0.657	C 29.620	AA NPT 2"	d1 A 4	d2 A 4
Flange FD-406	AJ 16.000	AK 14.000	BD 18.000	BF 0.828
BB 0.203				

Performed by:

Checked:

Customer:

Oil Well Pumping : High Slip - NEMA Design "D" - TEFC (IP55)

Three-phase induction motor
Frame 324T - IP55

27-DEC-2012

