



No.:

Date: 27-DEC-2012

Customer :

TECHNICAL PROPOSAL

Three-phase induction motor - Squirrel cage rotor

Product line : Close Coupled Pump: Three-Phase - W22 "JM" Type - TEFC - NEMA Premium

Catalog Number : 02518ET3E284JM-W22

List Price : \$3,734

Notes:

Performed by:

Checked:



No.:

Date: 27-DEC-2012

DATA SHEET

Three-phase induction motor - Squirrel cage rotor

Customer :
Product line : Close Coupled Pump: Three-Phase - W22 "JM" Type - TEFC - NEMA Premium

Frame : 284JM
Output : 25 HP
Frequency : 60 Hz
Poles : 4
Full load speed : 1765
Slip : 1.94 %
Voltage : 208-230/460 V
Rated current : 65.2-59.0/29.5 A
Locked rotor current : 366/183 A
Locked rotor current (I_L/I_n) : 6.2
No-load current : 24.0/12.0 A
Full load torque : 73.4 lb.ft
Locked rotor torque : 240 %
Breakdown torque : 270 %
Design : B
Insulation class : F
Temperature rise : 80 K
Locked rotor time : 24 s (hot)
Service factor : 1.25
Duty cycle : S1
Ambient temperature : -20°C - +40°C
Altitude : 1000
Degree of Protection : IP55
Approximate weight : 388 lb
Moment of inertia : 5.1084 sq.ft.lb
Noise level : 64 dB(A)

	D.E.	N.D.E.	Load	Power factor	Efficiency (%)
Bearings	6311 C3	6211 C3	100%	0.84	93.6
Regreasing interval	20000 h	20000 h	75%	0.80	93.0
Grease amount	18 g	11 g	50%	0.70	92.4

Notes:

Performed by

Checked



No.:

Date: 27-DEC-2012

PERFORMANCE CURVES RELATED TO RATED OUTPUT Three-phase induction motor - Squirrel cage rotor

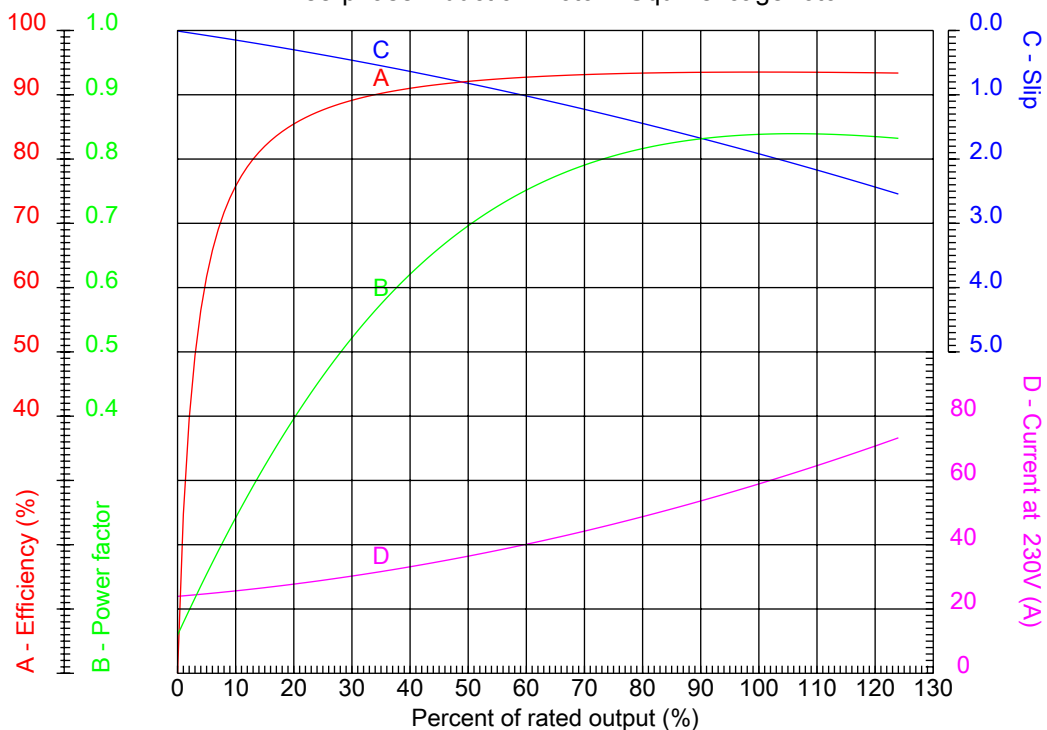

Customer :
Product line : Close Coupled Pump: Three-Phase - W22 "JM" Type - TEFC - NEMA Premium

Frame : 284JM	Locked rotor current (I _l /I _n) : 6.2
Output : 25 HP	Duty cycle : S1
Frequency : 60 Hz	Service factor : 1.25
Full load speed : 1765	Design : B
Voltage : 208-230/460 V	Locked rotor torque : 240 %
Rated current : 65.2-59.0/29.5 A	Breakdown torque : 270 %
Insulation class : F	

Notes:

Performed by

Checked



No.:

Date: 27-DEC-2012

CHARACTERISTIC CURVES RELATED TO SPEED

Three-phase induction motor - Squirrel cage rotor

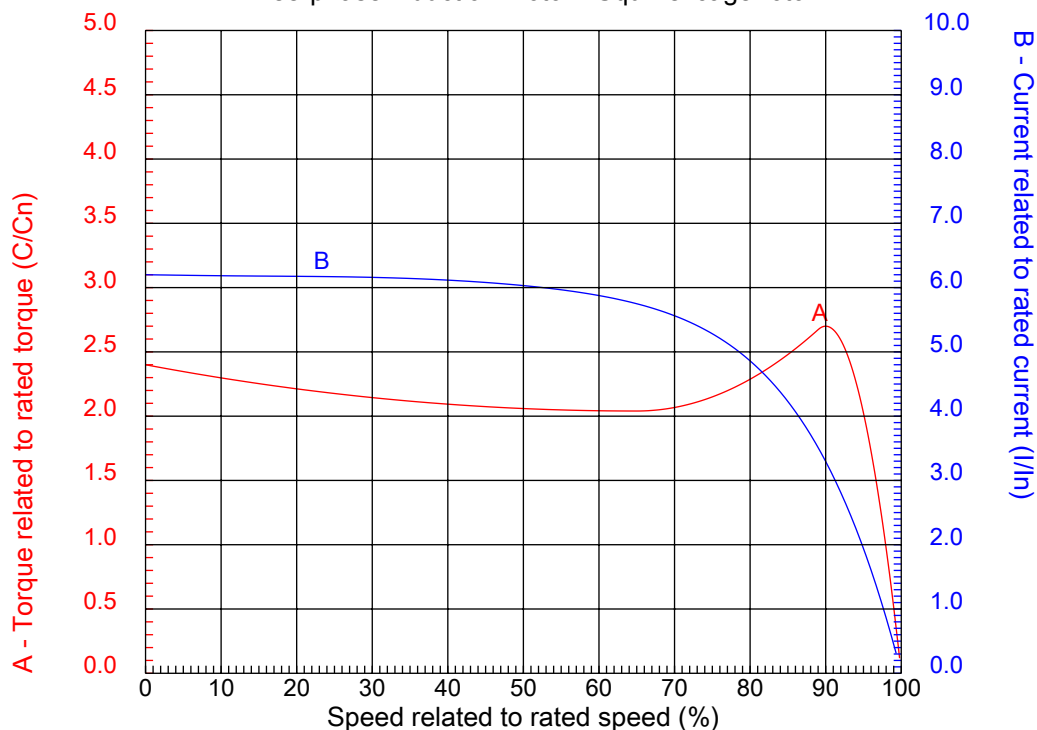

Customer :
Product line : Close Coupled Pump: Three-Phase - W22 "JM" Type - TEFC - NEMA Premium

Frame	: 284JM	Locked rotor current (I _l /I _n)	: 6.2
Output	: 25 HP	Duty cycle	: S1
Frequency	: 60 Hz	Service factor	: 1.25
Full load speed	: 1765	Design	: B
Voltage	: 208-230/460 V	Locked rotor torque	: 240 %
Rated current	: 65.2-59.0/29.5 A	Breakdown torque	: 270 %
Insulation class	: F		

Notes:

Performed by

Checked

1 2 3 4 5 6 7 8

A

B

C

D

E

F

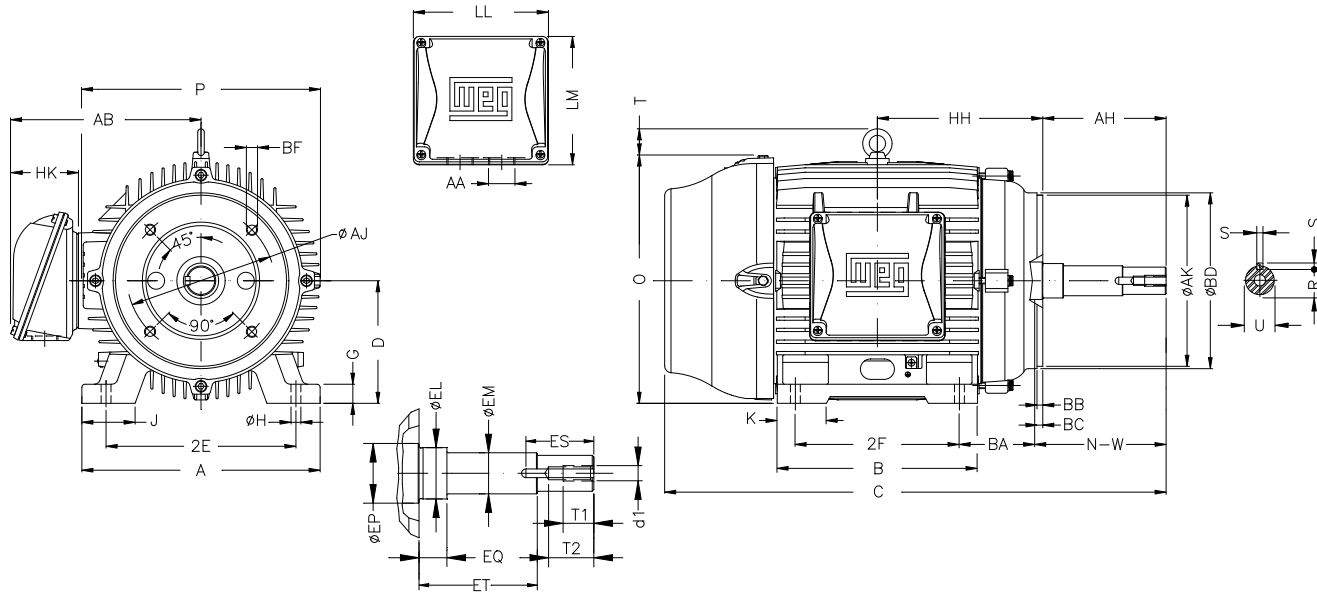

Notes:

2E 11.000	J 3.110	A 13.780	P 14.173	AB 10.984
2F 9.500	K 2.874	B 11.575	BA 4.750	D 7.000
G 1.023	O 14.067	T 2.087	HD 16.154	H 0.531
AA NPT 1 1/2"	ER 5.250	EQ 0.630	ET 3.006	U 1.249
EM 1.375	EL 1.750	EP 2.163	ES 2.480	t1 0.984
t2 1.496	C 27.165	Flange FC-279	AJ 11.000	AK 12.500
BD 13.593	BF UNC 5/8"x11	BB 0.248	BC ---	AH 5.250

Performed by:

Checked:

Customer:

Close Coupled Pump: Three-Phase - W22 "JM" Type - TEFC - NEMA Premium

Three-phase induction motor
Frame 284JM - IP55

27-DEC-2012

