



No.:

Date: 27-DEC-2012

Customer :

TECHNICAL PROPOSAL

Three-phase induction motor - Squirrel cage rotor

Product line : Three-Phase: W22 IEEE-841™ Petrochem Motors - NEMA Premium® Efficiency

Catalog Number : 12512ST3QIE445T-W22

List Price : \$20,158

Notes:

Performed by:

Checked:



No.:

Date: 27-DEC-2012

DATA SHEET

Three-phase induction motor - Squirrel cage rotor

Customer :
Product line : Three-Phase: W22 IEEE-841™ Petrochem Motors - NEMA Premium® Efficiency

Frame : 444/5T
Output : 125 HP
Frequency : 60 Hz
Poles : 6
Full load speed : 1185
Slip : 1.25 %
Voltage : 460 V
Rated current : 143 A
Locked rotor current : 915 A
Locked rotor current (I_L/I_n) : 6.4
No-load current : 56.0 A
Full load torque : 547 lb.ft
Locked rotor torque : 210 %
Breakdown torque : 240 %
Design : B
Insulation class : F
Temperature rise : 80 K
Locked rotor time : 19 s (hot)
Service factor : 1.15
Duty cycle : S1
Ambient temperature : -20°C - +40°C
Altitude : 1000
Degree of Protection : IP55
Approximate weight : 1751 lb
Moment of inertia : 103.62 sq.ft.lb
Noise level : 69 dB(A)

	D.E.	N.D.E.	Load	Power factor	Efficiency (%)
Bearings	6319 C3	6316 C3	100%	0.83	95.0
Regreasing interval	13000 h	16000 h	75%	0.79	95.4
Grease amount	45 g	34 g	50%	0.70	95.0

Notes:

Performed by

Checked



No.:

Date: 27-DEC-2012

PERFORMANCE CURVES RELATED TO RATED OUTPUT Three-phase induction motor - Squirrel cage rotor

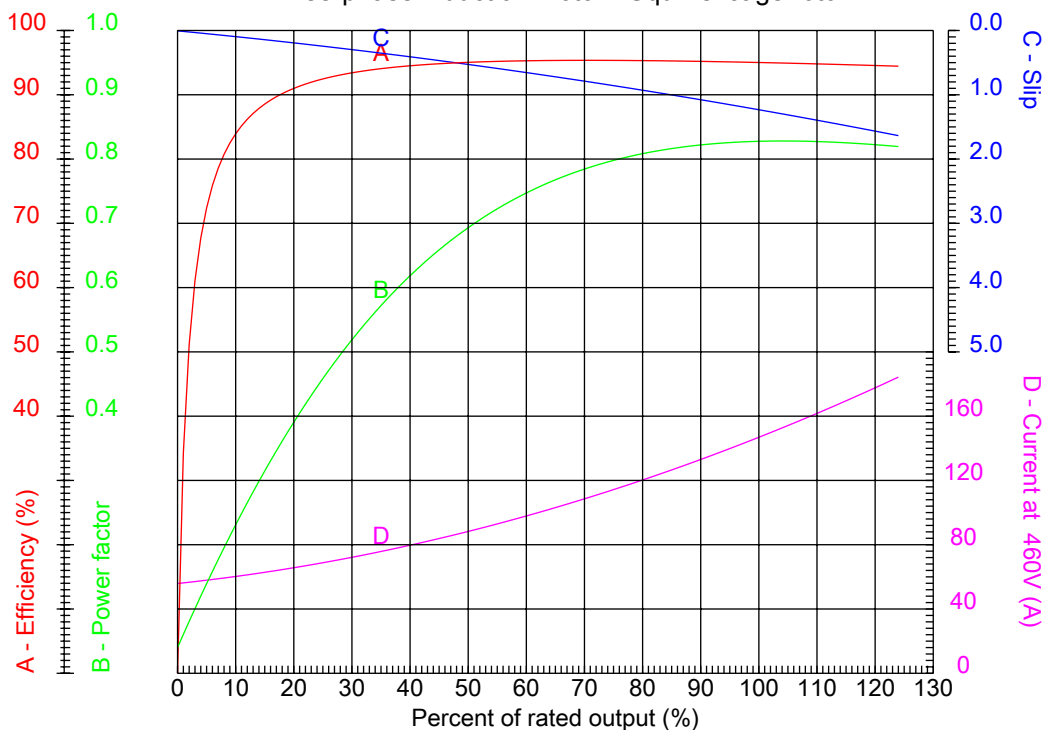

Customer :
Product line : Three-Phase: W22 IEEE-841™ Petrochem Motors - NEMA Premium® Efficiency

Frame : 444/5T	Locked rotor current (I _l /I _n) : 6.4
Output : 125 HP	Duty cycle : S1
Frequency : 60 Hz	Service factor : 1.15
Full load speed : 1185	Design : B
Voltage : 460 V	Locked rotor torque : 210 %
Rated current : 143 A	Breakdown torque : 240 %
Insulation class : F	

Notes:

Performed by

Checked



No.:

Date: 27-DEC-2012

CHARACTERISTIC CURVES RELATED TO SPEED Three-phase induction motor - Squirrel cage rotor

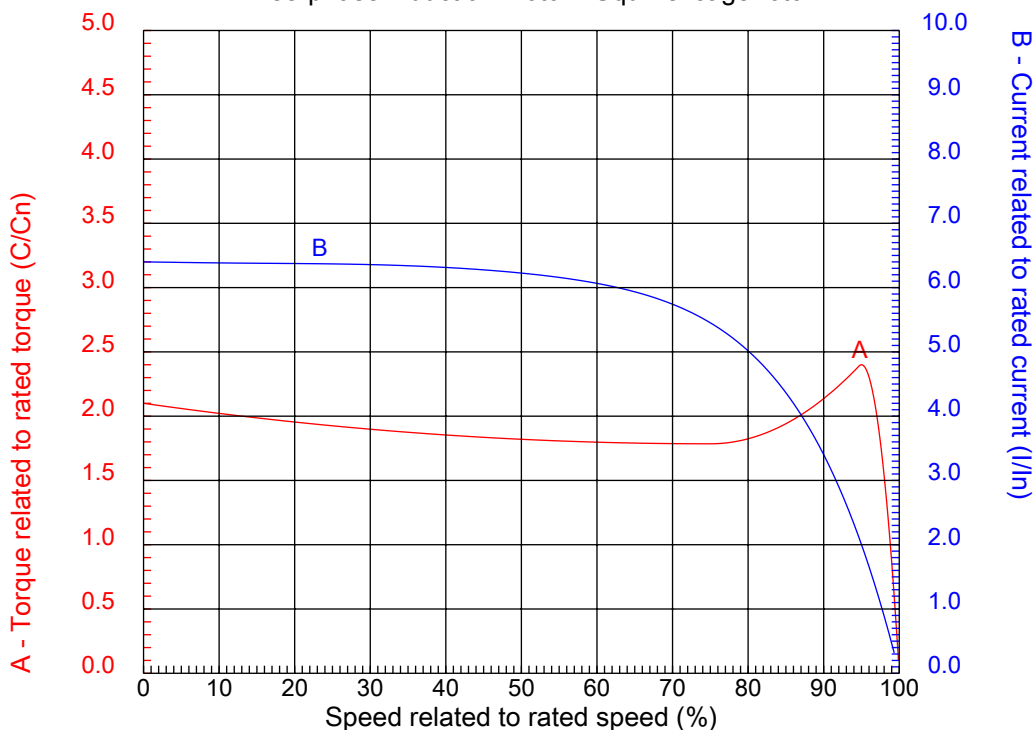

Customer :
Product line : Three-Phase: W22 IEEE-841™ Petrochem Motors - NEMA Premium® Efficiency

Frame	: 444/5T	Locked rotor current (I _l /I _n)	: 6.4
Output	: 125 HP	Duty cycle	: S1
Frequency	: 60 Hz	Service factor	: 1.15
Full load speed	: 1185	Design	: B
Voltage	: 460 V	Locked rotor torque	: 210 %
Rated current	: 143 A	Breakdown torque	: 240 %
Insulation class	: F		

Notes:

Performed by

Checked

1 2 3 4 5 6 7 8

A

B

C

D

E

F

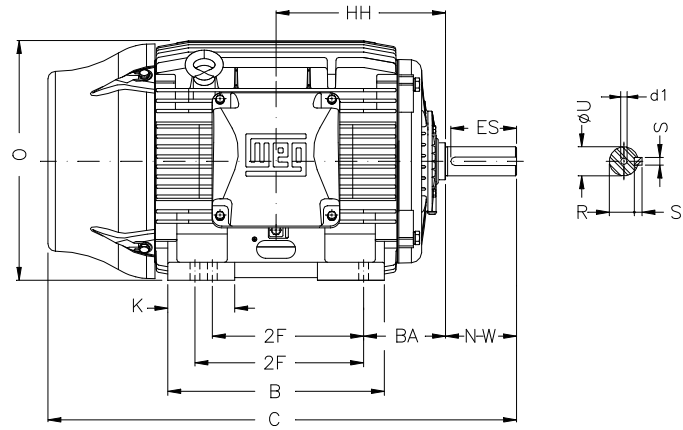

2E	J	A	P	AB
18.000	3.937	21.929	23.583	18.622
2F	K	B	BA	U
14.500/16.500	5.866	20.315	7.500	3.375
N-W	ES	S	R	depth
8.500	7.087	0.875	2.880	0.875
D	G	HB	O	T
11.000	1.630	5.039	22.795	4.567
HD	HH	HK	H	C
27.362	15.748	6.023	0.810	44.950
LL	LM	AA	d1	d2
12.362	12.244	2XNPT 3"	DUNC 3/4"-10	DUNC 3/4"-10
Flange	AJ	AK	BD	BF
FD-508	20.000	18.000	21.65	0.828
BB				
0.203				

Notes:

Performed by:

Checked:

Customer:

Three-Phase: W22 IEEE-841™ Petrochem Motors - NEMA Premium® Efficiency

Three-phase induction motor
Frame 444/5T - IP55

27-DEC-2012

