



No.:

Date: 28-DEC-2012

Customer :

TECHNICAL PROPOSAL

Three-phase induction motor - Squirrel cage rotor

Product line : Three-Phase: W22 IEEE-841™ Petrochem Motors - NEMA Premium® Efficiency

Catalog Number : 25012ST3QIE449T-W22

List Price : \$39,415

Notes:

Performed by:

Checked:



No.:

Date: 28-DEC-2012

DATA SHEET

Three-phase induction motor - Squirrel cage rotor

Customer :
Product line : Three-Phase: W22 IEEE-841™ Petrochem Motors - NEMA Premium® Efficiency

Frame : 447/9T
Output : 250 HP
Frequency : 60 Hz
Poles : 6
Full load speed : 1185
Slip : 1.25 %
Voltage : 460 V
Rated current : 292 A
Locked rotor current : 1750 A
Locked rotor current (I_L/I_n) : 6.0
No-load current : 120 A
Full load torque : 1093 lb.ft
Locked rotor torque : 240 %
Breakdown torque : 240 %
Design : B
Insulation class : F
Temperature rise : 80 K
Locked rotor time : 12 s (hot)
Service factor : 1.15
Duty cycle : S1
Ambient temperature : -20°C - +40°C
Altitude : 1000
Degree of Protection : IP55
Approximate weight : 2538 lb
Moment of inertia : 144.52 sq.ft.lb
Noise level : ---

	D.E.	N.D.E.	Load	Power factor	Efficiency (%)
Bearings	6322 C3	6319 C3	100%	0.83	95.8
Regreasing interval	11000 h	13000 h	75%	0.79	95.4
Grease amount	60 g	45 g	50%	0.68	95.0

Notes:

Performed by

Checked



No.:

Date: 28-DEC-2012

PERFORMANCE CURVES RELATED TO RATED OUTPUT

Three-phase induction motor - Squirrel cage rotor

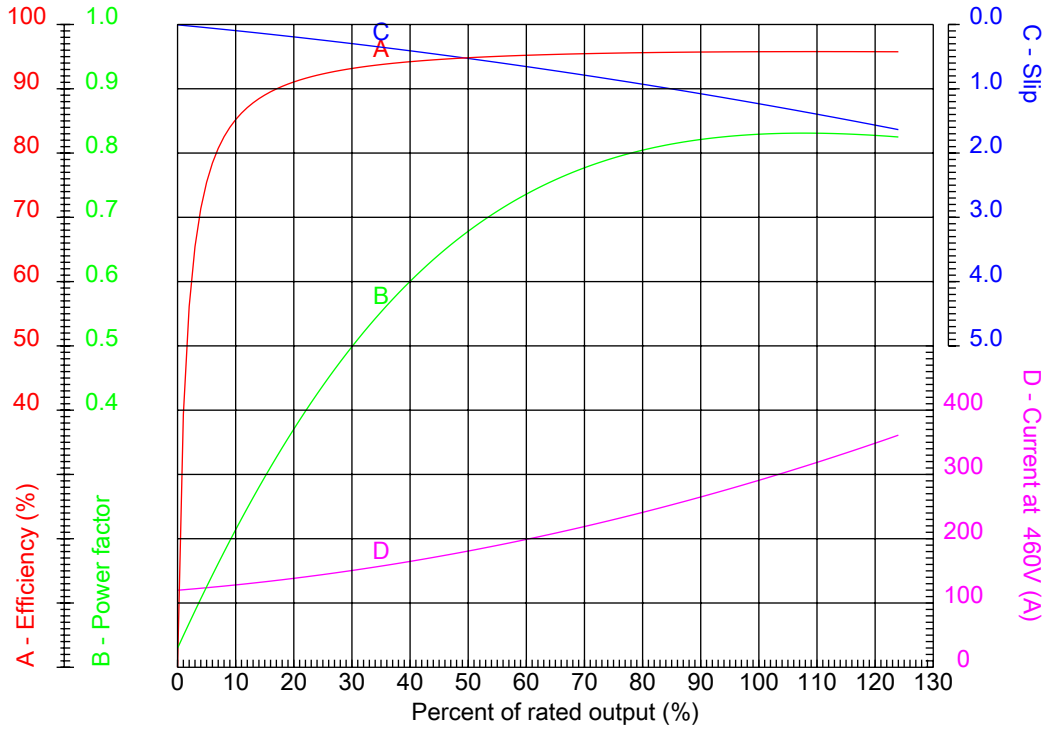

Customer :
Product line : Three-Phase: W22 IEEE-841™ Petrochem Motors - NEMA Premium® Efficiency

Frame : 447/9T	Locked rotor current (I _l /I _n) : 6.0
Output : 250 HP	Duty cycle : S1
Frequency : 60 Hz	Service factor : 1.15
Full load speed : 1185	Design : B
Voltage : 460 V	Locked rotor torque : 240 %
Rated current : 292 A	Breakdown torque : 240 %
Insulation class : F	

Notes:

Performed by

Checked



No.:

Date: 28-DEC-2012

CHARACTERISTIC CURVES RELATED TO SPEED Three-phase induction motor - Squirrel cage rotor

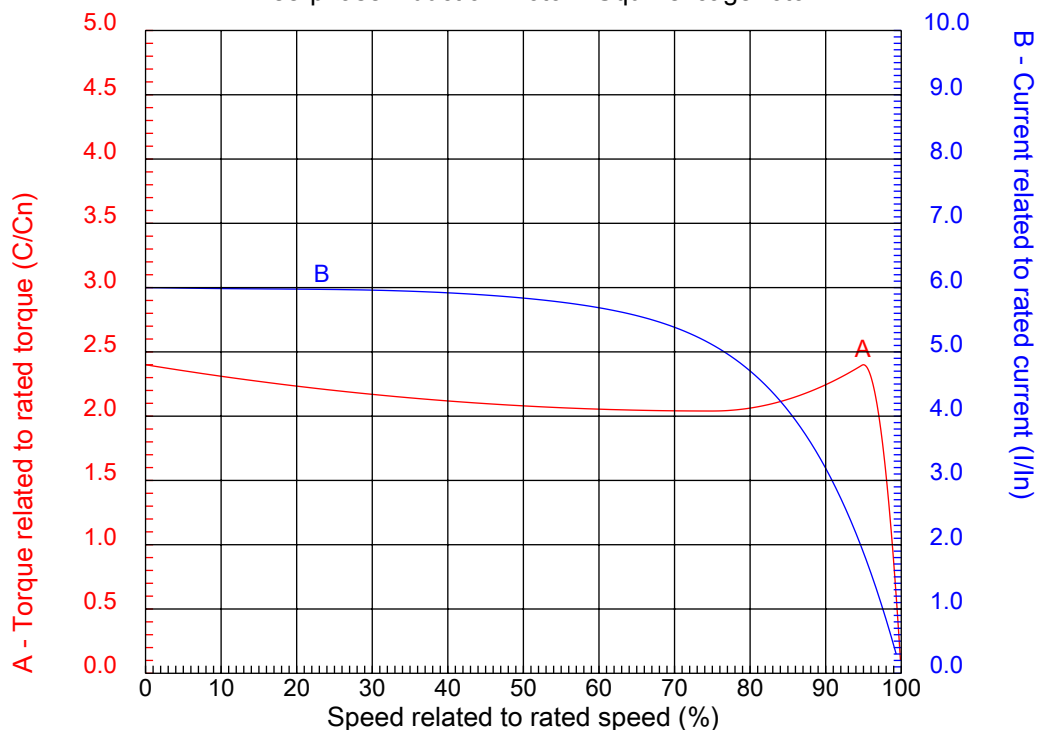

Customer :
Product line : Three-Phase: W22 IEEE-841™ Petrochem Motors - NEMA Premium® Efficiency

Frame	: 447/9T	Locked rotor current (I _l /I _n)	: 6.0
Output	: 250 HP	Duty cycle	: S1
Frequency	: 60 Hz	Service factor	: 1.15
Full load speed	: 1185	Design	: B
Voltage	: 460 V	Locked rotor torque	: 240 %
Rated current	: 292 A	Breakdown torque	: 240 %
Insulation class	: F		

Notes:

Performed by

Checked

1 2 3 4 5 6 7 8

A

B

C

D

E

F

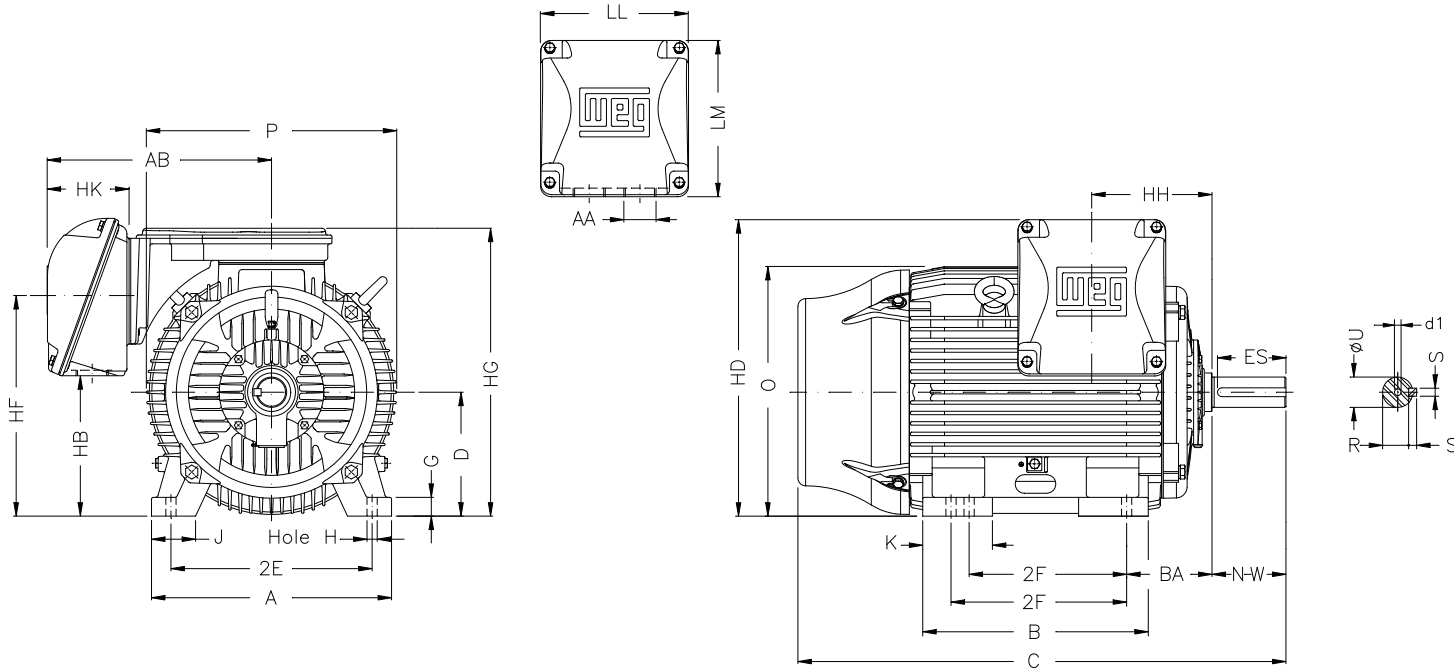

Notes:

Performed by:

Checked:

Customer:

Three-Phase: W22 IEEE-841™ Petrochem Motors - NEMA Premium® Efficiency

Three-phase induction motor
Frame 447/9T - IP55

28-DEC-2012



2E	J	A	P	AB
18.000	3.937	21.929	23.583	20.670
2F	K	B	BA	U
20.000/25.000	11.77	31.535	7.500	3.375
N-W	ES	S	R	depth
8.500	7.087	0.875	2.880	0.875
D	G	HB	O	T
11.000	1.630	12.598	22.795	7.378
HD	HF	HG	HH	HK
30.173	20.724	26.850	11.803	6.968
H	C	LL	LM	AA
0.810	56.338	14.646	15.040	2XNPT 3"
d1	d2	Flange	AJ	AK
DUNC 3/4"-10	DUNC 3/4"-10	FD-508	20.000	18.000
BD	BF	BB		
21.65	0.828	0.203		