



No.:

Date: 31-DEC-2012

Customer :

TECHNICAL PROPOSAL

Three-phase induction motor - Squirrel cage rotor

Product line : W22 Cooling Tower Motors: NEMA Premium

Catalog Number : 00112ET3ECT145T-W22

List Price : \$728

Notes:

Performed by:

Checked:



No.:

Date: 31-DEC-2012

DATA SHEET

Three-phase induction motor - Squirrel cage rotor

Customer :
Product line : W22 Cooling Tower Motors: NEMA Premium

Frame : 145T
Output : 1 HP
Frequency : 60 Hz
Poles : 6
Full load speed : 1150
Slip : 4.17 %
Voltage : 208-230/460 V
Rated current : 3.82-3.45/1.73 A
Locked rotor current : 21.4/10.7 A
Locked rotor current (I_L/I_n) : 6.2
No-load current : 2.18/1.09 A
Full load torque : 4.51 lb.ft
Locked rotor torque : 300 %
Breakdown torque : 300 %
Design : B
Insulation class : F
Temperature rise : 80 K
Locked rotor time : 28 s (hot)
Service factor : 1.25
Duty cycle : S1
Ambient temperature : -20°C - +40°C
Altitude : 1000
Degree of Protection : IP55
Approximate weight : 53 lb
Moment of inertia : 0.15947 sq.ft.lb
Noise level : 49 dB(A)

	D.E.	N.D.E.	Load	Power factor	Efficiency (%)
Bearings	6205 ZZ	6204 ZZ	100%	0.66	82.5
Regreasing interval	---	---	75%	0.57	82.0
Grease amount	---	---	50%	0.45	77.0

Notes:

Performed by

Checked



No.:

Date: 31-DEC-2012

PERFORMANCE CURVES RELATED TO RATED OUTPUT

Three-phase induction motor - Squirrel cage rotor

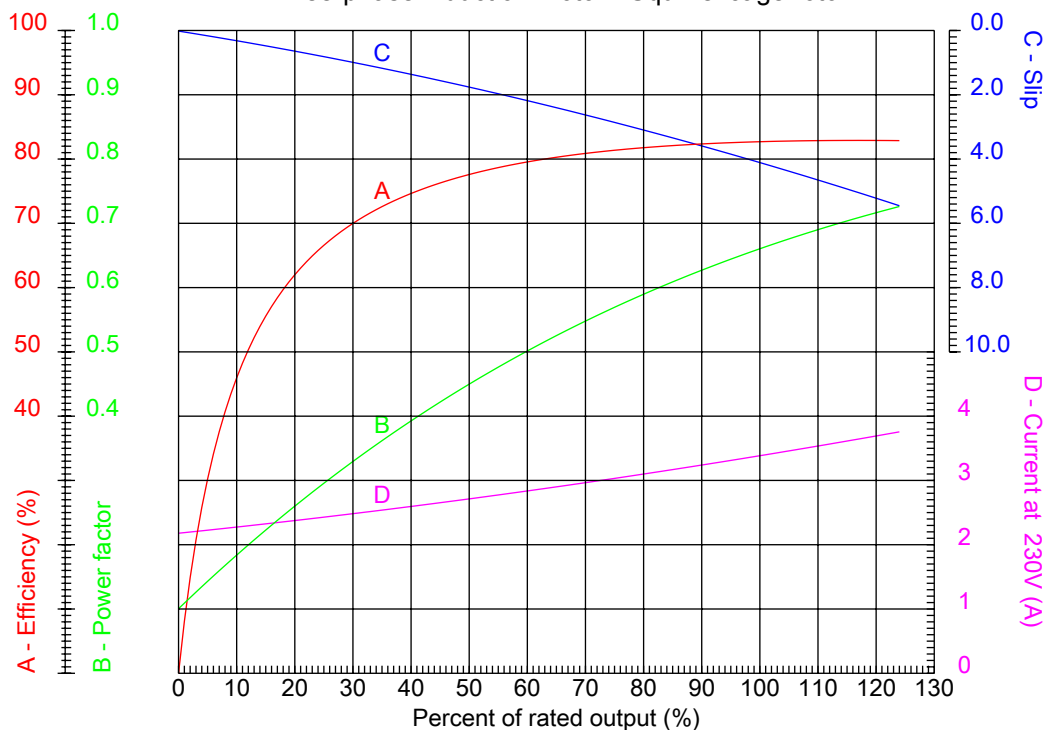

Customer :
Product line : W22 Cooling Tower Motors: NEMA Premium

Frame	: 145T	Locked rotor current (I _l /I _n)	: 6.2
Output	: 1 HP	Duty cycle	: S1
Frequency	: 60 Hz	Service factor	: 1.25
Full load speed	: 1150	Design	: B
Voltage	: 208-230/460 V	Locked rotor torque	: 300 %
Rated current	: 3.82-3.45/1.73 A	Breakdown torque	: 300 %
Insulation class	: F		

Notes:

Performed by

Checked



No.:

Date: 31-DEC-2012

CHARACTERISTIC CURVES RELATED TO SPEED

Three-phase induction motor - Squirrel cage rotor

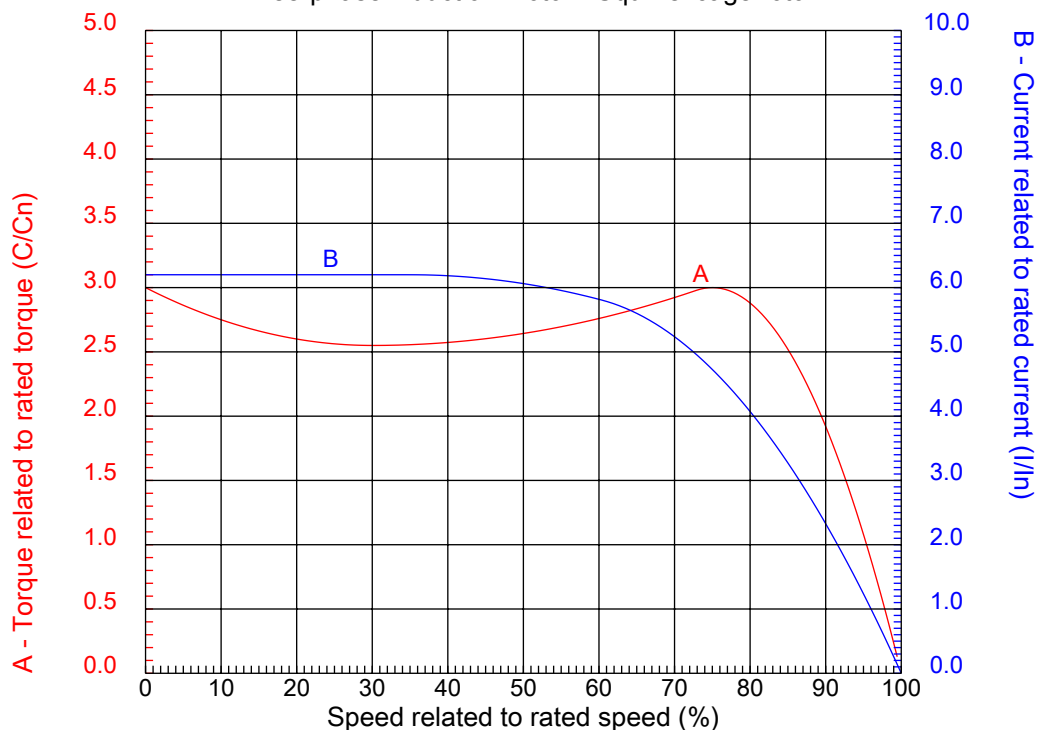

Customer :
Product line : W22 Cooling Tower Motors: NEMA Premium

Frame	: 145T	Locked rotor current (I _l /I _n)	: 6.2
Output	: 1 HP	Duty cycle	: S1
Frequency	: 60 Hz	Service factor	: 1.25
Full load speed	: 1150	Design	: B
Voltage	: 208-230/460 V	Locked rotor torque	: 300 %
Rated current	: 3.82-3.45/1.73 A	Breakdown torque	: 300 %
Insulation class	: F		

Notes:

Performed by

Checked

1 2 3 4 5 6 7 8

A

B

C

D

E

F

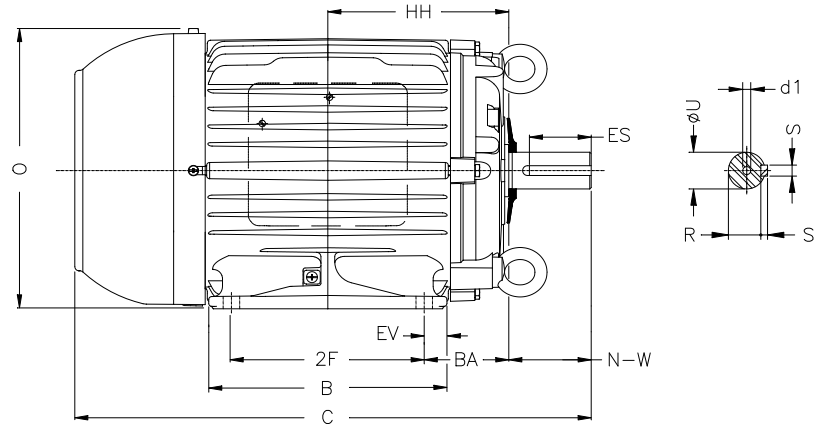
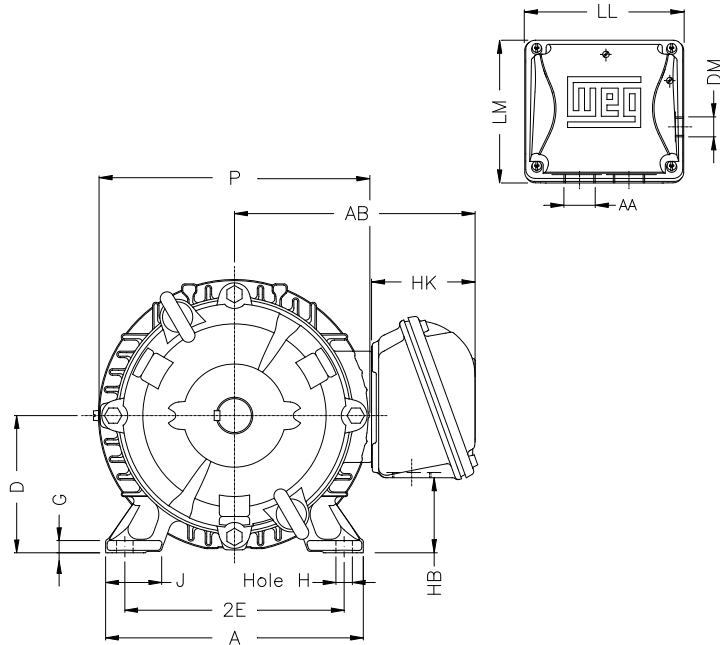

Notes:

Performed by:

Checked:

Customer:

W22 Cooling Tower Motors: NEMA Premium

Three-phase induction motor
Frame 145T - IP55

31-DEC-2012



2E 5.500	J 1.437	A 6.457	P 6.850	AB 6.260
2F 5.000	B 6.142	BA 2.250	U 0.875	N-W 2.250
ES 1.575	S 0.187	R 0.765	depth 0.187	D 3.500
G 0.354	HB 1.788	O 7.122	HF 3.500	HH 4.750
HK 2.717	H 0.344	C 13.346	LL 4.527	LM 4.094
AA NPT 3/4"	d1 A 4	d2 A 4		