



No.:

Date: 31-DEC-2012

Customer :

TECHNICAL PROPOSAL

Three-phase induction motor - Squirrel cage rotor

Product line : W22 Cooling Tower Motors: NEMA Premium

Catalog Number : 00518ET3ECT184T-W22

List Price : \$894

Notes:

Performed by:

Checked:



No.:

Date: 31-DEC-2012

DATA SHEET

Three-phase induction motor - Squirrel cage rotor

Customer :
Product line : W22 Cooling Tower Motors: NEMA Premium

Frame : 184T
Output : 5 HP
Frequency : 60 Hz
Poles : 4
Full load speed : 1755
Slip : 2.50 %
Voltage : 208-230/460 V
Rated current : 14.3-12.9/6.45 A
Locked rotor current : 96.8/48.4 A
Locked rotor current (I_L/I_n) : 7.5
No-load current : 6.40/3.20 A
Full load torque : 14.8 lb.ft
Locked rotor torque : 230 %
Breakdown torque : 320 %
Design : B
Insulation class : F
Temperature rise : 80 K
Locked rotor time : 15 s (hot)
Service factor : 1.25
Duty cycle : S1
Ambient temperature : -20°C - +40°C
Altitude : 1000
Degree of Protection : IP55
Approximate weight : 95 lb
Moment of inertia : 0.40033 sq.ft.lb
Noise level : 56 dB(A)

	D.E.	N.D.E.	Load	Power factor	Efficiency (%)
Bearings	6207 ZZ	6206 ZZ	100%	0.80	89.5
Regreasing interval	---	---	75%	0.74	89.5
Grease amount	---	---	50%	0.62	88.5

Notes:

Performed by

Checked



No.:

Date: 31-DEC-2012

PERFORMANCE CURVES RELATED TO RATED OUTPUT
Three-phase induction motor - Squirrel cage rotor

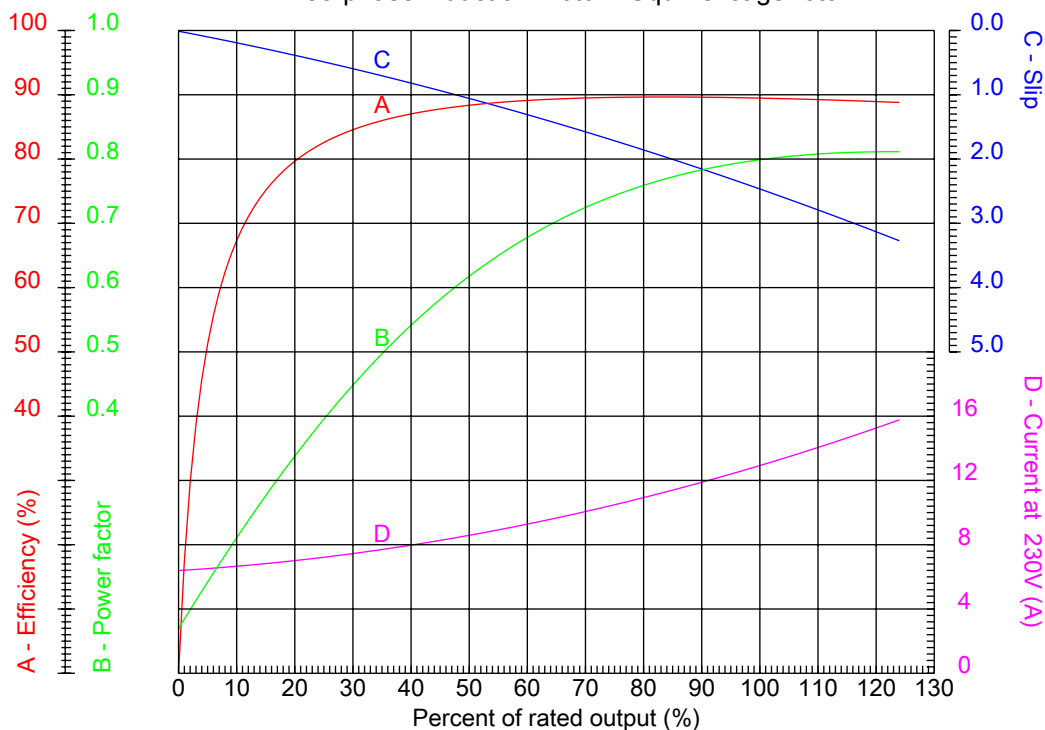

Customer :
Product line : W22 Cooling Tower Motors: NEMA Premium

Frame	: 184T	Locked rotor current (I _l /I _n)	: 7.5
Output	: 5 HP	Duty cycle	: S1
Frequency	: 60 Hz	Service factor	: 1.25
Full load speed	: 1755	Design	: B
Voltage	: 208-230/460 V	Locked rotor torque	: 230 %
Rated current	: 14.3-12.9/6.45 A	Breakdown torque	: 320 %
Insulation class	: F		

Notes:

Performed by

Checked



No.:

Date: 31-DEC-2012

CHARACTERISTIC CURVES RELATED TO SPEED Three-phase induction motor - Squirrel cage rotor

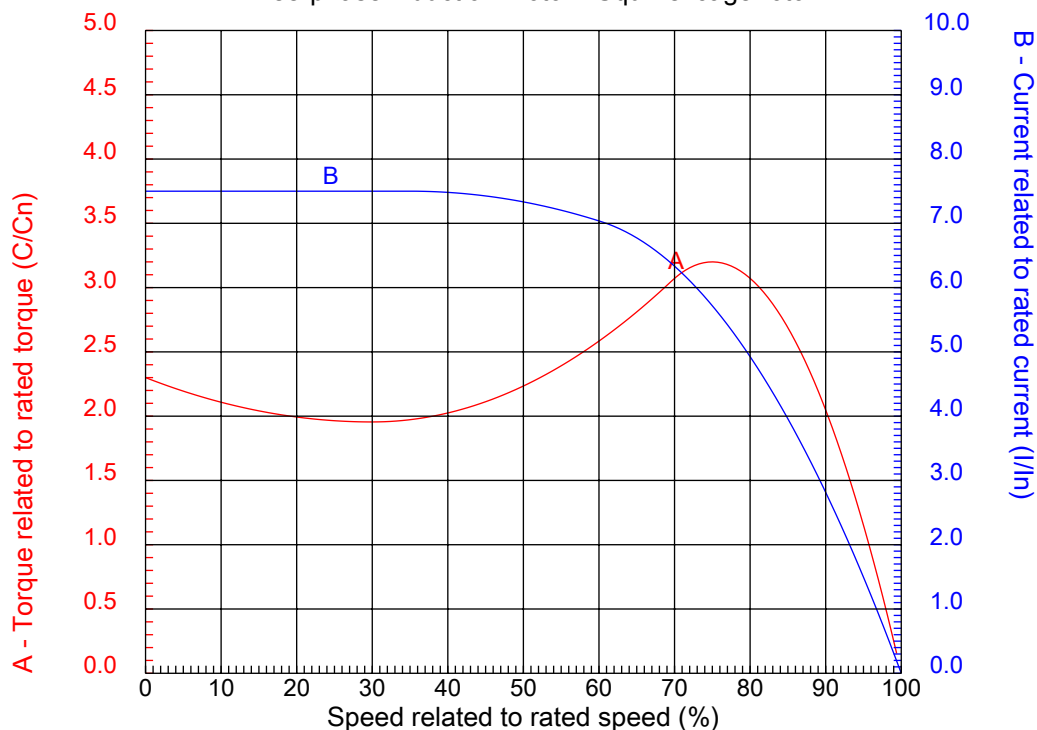

Customer :
Product line : W22 Cooling Tower Motors: NEMA Premium

Frame	: 184T	Locked rotor current (I _l /I _n)	: 7.5
Output	: 5 HP	Duty cycle	: S1
Frequency	: 60 Hz	Service factor	: 1.25
Full load speed	: 1755	Design	: B
Voltage	: 208-230/460 V	Locked rotor torque	: 230 %
Rated current	: 14.3-12.9/6.45 A	Breakdown torque	: 320 %
Insulation class	: F		

Notes:

Performed by

Checked

1 2 3 4 5 6 7 8

A

B

C

D

E

F

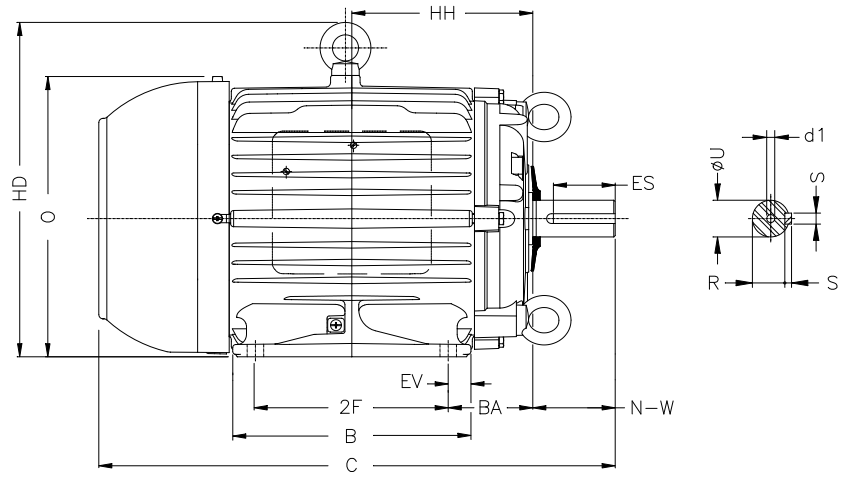
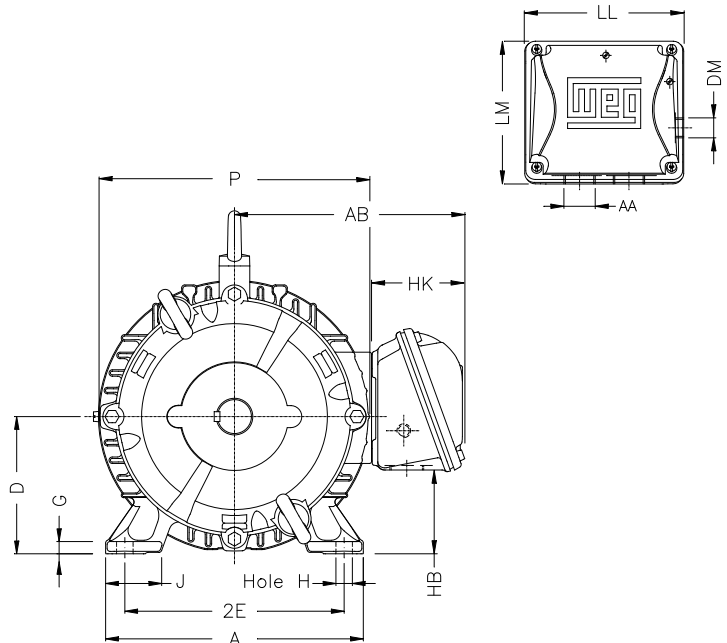

Notes:

Performed by:

Checked:

Customer:

W22 Cooling Tower Motors: NEMA Premium

Three-phase induction motor
Frame 184T - IP55

31-DEC-2012



2E 7.500	J 1.594	A 8.661	P 8.504	AB 7.559
2F 5.500	B 6.969	BA 2.750	U 1.125	N-W 2.750
ES 1.969	S 0.250	R 0.984	depth 0.250	D 4.500
G 0.394	HB 2.236	O 9.343	T 1.772	HD 11.115
HF 4.500	HH 5.500	HK 3.155	H 0.406	C 15.860
LL 5.512	LM 5.236	AA NPT 1"	d1 A 4	d2 A 4