



No.:

Date: 31-DEC-2012

Customer :

TECHNICAL PROPOSAL

Three-phase induction motor - Squirrel cage rotor

Product line : W22 Cooling Tower Motors: NEMA Premium

Catalog Number : 01518ET3PCT254T-W22

List Price : \$2,122

Notes:

Performed by:

Checked:



No.:

Date: 31-DEC-2012

DATA SHEET

Three-phase induction motor - Squirrel cage rotor

Customer :
Product line : W22 Cooling Tower Motors: NEMA Premium

Frame : 254T
Output : 15 HP
Frequency : 60 Hz
Poles : 4
Full load speed : 1765
Slip : 1.94 %
Voltage : 200 V
Rated current : 41.4 A
Locked rotor current : 269 A
Locked rotor current (I_L/I_n) : 6.5
No-load current : 18.4 A
Full load torque : 44.0 lb.ft
Locked rotor torque : 230 %
Breakdown torque : 270 %
Design : B
Insulation class : F
Temperature rise : 80 K
Locked rotor time : 17 s (hot)
Service factor : 1.25
Duty cycle : S1
Ambient temperature : -20°C - +40°C
Altitude : 1000
Degree of Protection : IP55
Approximate weight : 251 lb
Moment of inertia : 2.6198 sq.ft.lb
Noise level : 64 dB(A)

	D.E.	N.D.E.	Load	Power factor	Efficiency (%)
Bearings	6309 C3	6209 C3	100%	0.83	92.4
Regreasing interval	20000 h	20000 h	75%	0.78	91.7
Grease amount	13 g	9 g	50%	0.68	91.0

Notes:

Performed by

Checked



No.:

Date: 31-DEC-2012

PERFORMANCE CURVES RELATED TO RATED OUTPUT Three-phase induction motor - Squirrel cage rotor

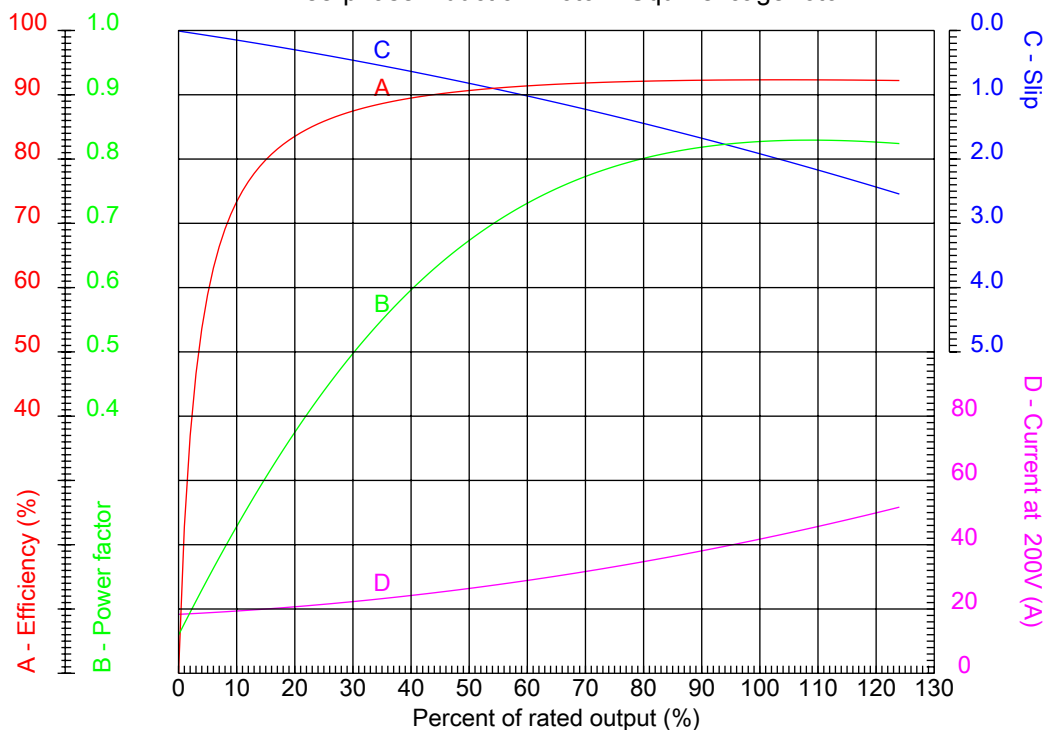

Customer :
Product line : W22 Cooling Tower Motors: NEMA Premium

Frame : 254T	Locked rotor current (I _l /I _n) : 6.5
Output : 15 HP	Duty cycle : S1
Frequency : 60 Hz	Service factor : 1.25
Full load speed : 1765	Design : B
Voltage : 200 V	Locked rotor torque : 230 %
Rated current : 41.4 A	Breakdown torque : 270 %
Insulation class : F	

Notes:

Performed by

Checked



No.:

Date: 31-DEC-2012

CHARACTERISTIC CURVES RELATED TO SPEED

Three-phase induction motor - Squirrel cage rotor

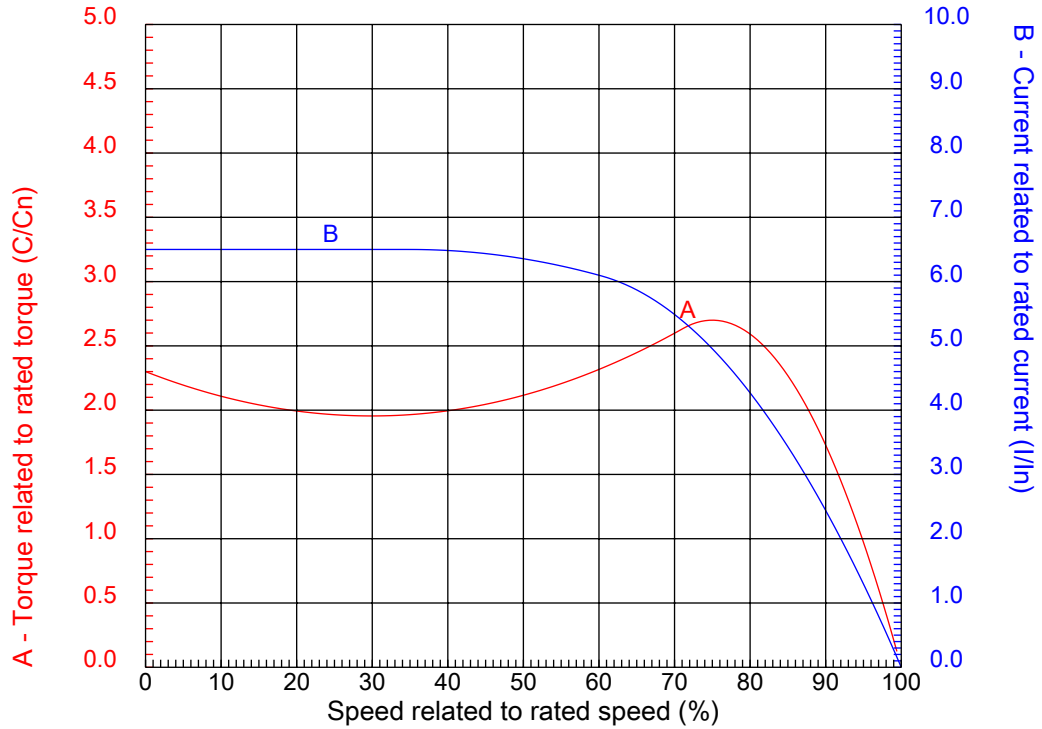

Customer :
Product line : W22 Cooling Tower Motors: NEMA Premium

Frame	: 254T	Locked rotor current (I _l /I _n)	: 6.5
Output	: 15 HP	Duty cycle	: S1
Frequency	: 60 Hz	Service factor	: 1.25
Full load speed	: 1765	Design	: B
Voltage	: 200 V	Locked rotor torque	: 230 %
Rated current	: 41.4 A	Breakdown torque	: 270 %
Insulation class	: F		

Notes:

Performed by

Checked

1 2 3 4 5 6 7 8

A

B

C

D

E

F

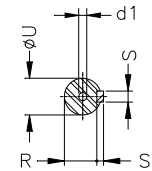
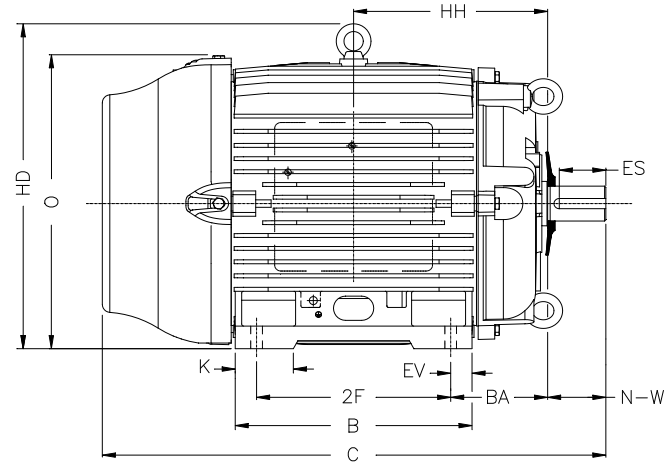
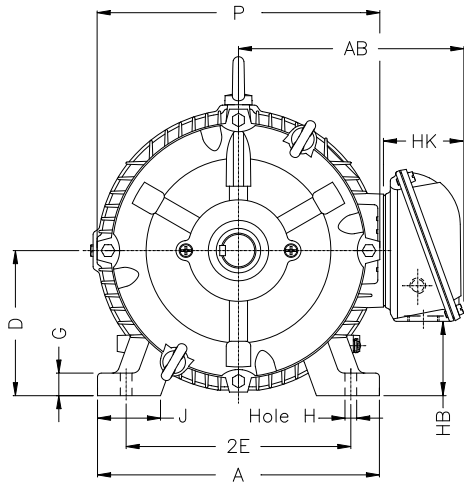
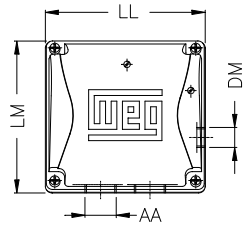

Notes:

Performed by:

Checked:

Customer:

W22 Cooling Tower Motors: NEMA Premium

Three-phase induction motor
Frame 254T - IP55

31-DEC-2012



2E 10.000	J 2.539	A 12.126	P 12.480	AB 10.483
2F 8.252	K 2.559	B 10.000	BA 4.250	U 1.625
N-W 4.000	ES 2.756	S 0.375	R 1.406	depth 0.375
D 6.250	G 0.827	HB 3.061	O 12.598	T 2.087
HD 14.685	HF 6.565	HH 8.376	HK 3.987	H 0.531
C 23.213	LL 7.813	LM 7.482	AA NPT 1 1/2"	d1 A 4
d2 A 4				