



No.:

Date: 31-DEC-2012

Customer :

TECHNICAL PROPOSAL

Three-phase induction motor - Squirrel cage rotor

Product line : W22 Cooling Tower Motors: NEMA Premium

Catalog Number : 02012ET3ECT286T-W22

List Price : \$4,635

Notes:

Performed by:

Checked:



No.:

Date: 31-DEC-2012

DATA SHEET

Three-phase induction motor - Squirrel cage rotor

Customer :
Product line : W22 Cooling Tower Motors: NEMA Premium

Frame : 286T
Output : 20 HP
Frequency : 60 Hz
Poles : 6
Full load speed : 1175
Slip : 2.08 %
Voltage : 208-230/460 V
Rated current : 53.5-48.4/24.2 A
Locked rotor current : 300/150 A
Locked rotor current (I_L/I_n) : 6.2
No-load current : 19.0/9.50 A
Full load torque : 88.2 lb.ft
Locked rotor torque : 230 %
Breakdown torque : 260 %
Design : B
Insulation class : F
Temperature rise : 80 K
Locked rotor time : 16 s (hot)
Service factor : 1.25
Duty cycle : S1
Ambient temperature : -20°C - +40°C
Altitude : 1000
Degree of Protection : IP55
Approximate weight : 426 lb
Moment of inertia : 9.1624 sq.ft.lb
Noise level : 59 dB(A)

	D.E.	N.D.E.	Load	Power factor	Efficiency (%)
Bearings	6311 C3	6211 C3	100%	0.85	91.7
Regreasing interval	20000 h	20000 h	75%	0.80	91.7
Grease amount	18 g	11 g	50%	0.70	91.0

Notes:

Performed by

Checked



No.:

Date: 31-DEC-2012

PERFORMANCE CURVES RELATED TO RATED OUTPUT

Three-phase induction motor - Squirrel cage rotor

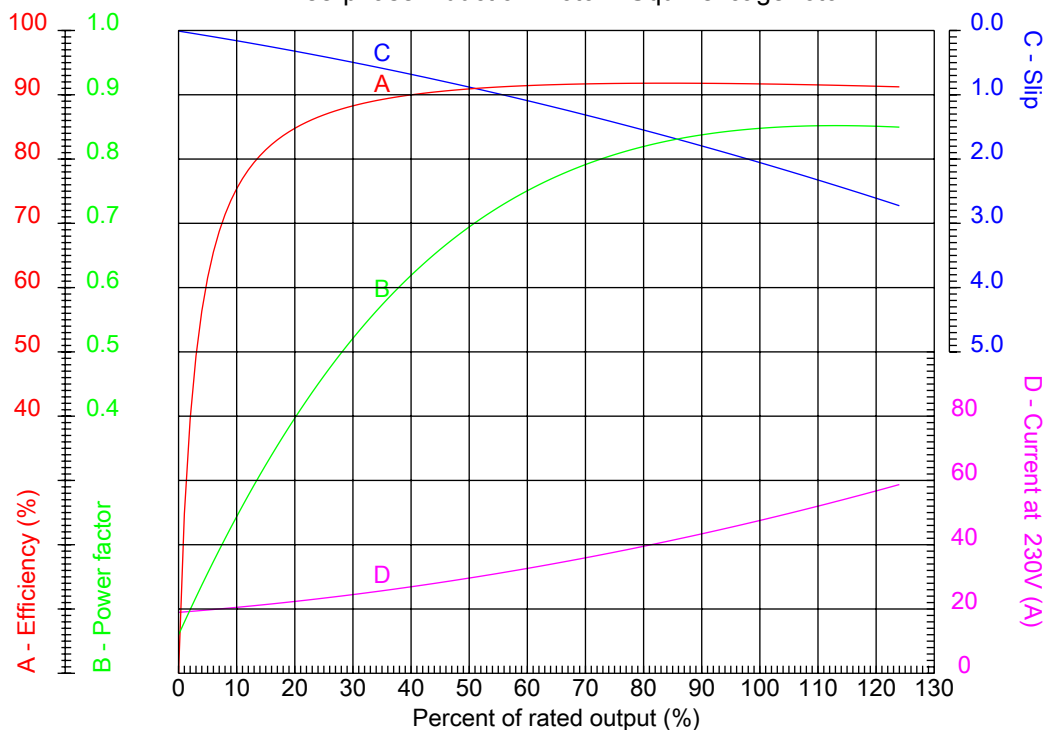

Customer :
Product line : W22 Cooling Tower Motors: NEMA Premium

Frame : 286T	Locked rotor current (I _l /I _n) : 6.2
Output : 20 HP	Duty cycle : S1
Frequency : 60 Hz	Service factor : 1.25
Full load speed : 1175	Design : B
Voltage : 208-230/460 V	Locked rotor torque : 230 %
Rated current : 53.5-48.4/24.2 A	Breakdown torque : 260 %
Insulation class : F	

Notes:

Performed by

Checked



No.:

Date: 31-DEC-2012

CHARACTERISTIC CURVES RELATED TO SPEED

Three-phase induction motor - Squirrel cage rotor

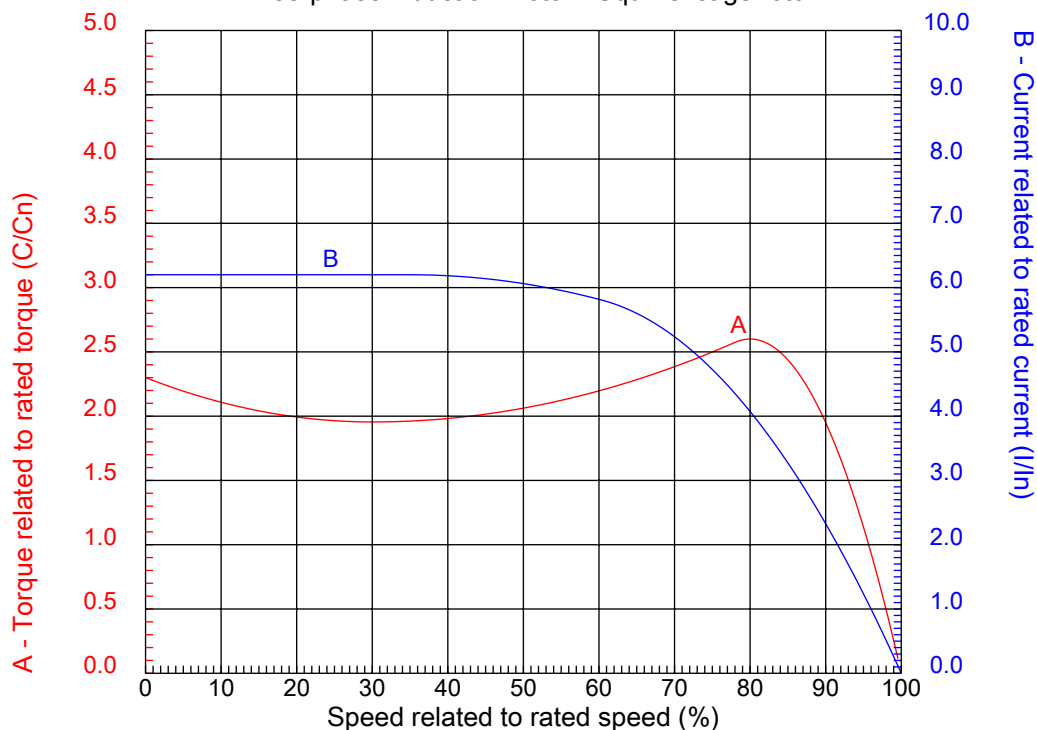

Customer :
Product line : W22 Cooling Tower Motors: NEMA Premium

Frame	: 286T	Locked rotor current (I _l /I _n)	: 6.2
Output	: 20 HP	Duty cycle	: S1
Frequency	: 60 Hz	Service factor	: 1.25
Full load speed	: 1175	Design	: B
Voltage	: 208-230/460 V	Locked rotor torque	: 230 %
Rated current	: 53.5-48.4/24.2 A	Breakdown torque	: 260 %
Insulation class	: F		

Notes:

Performed by

Checked

1 2 3 4 5 6 7 8

A

B

C

D

E

F

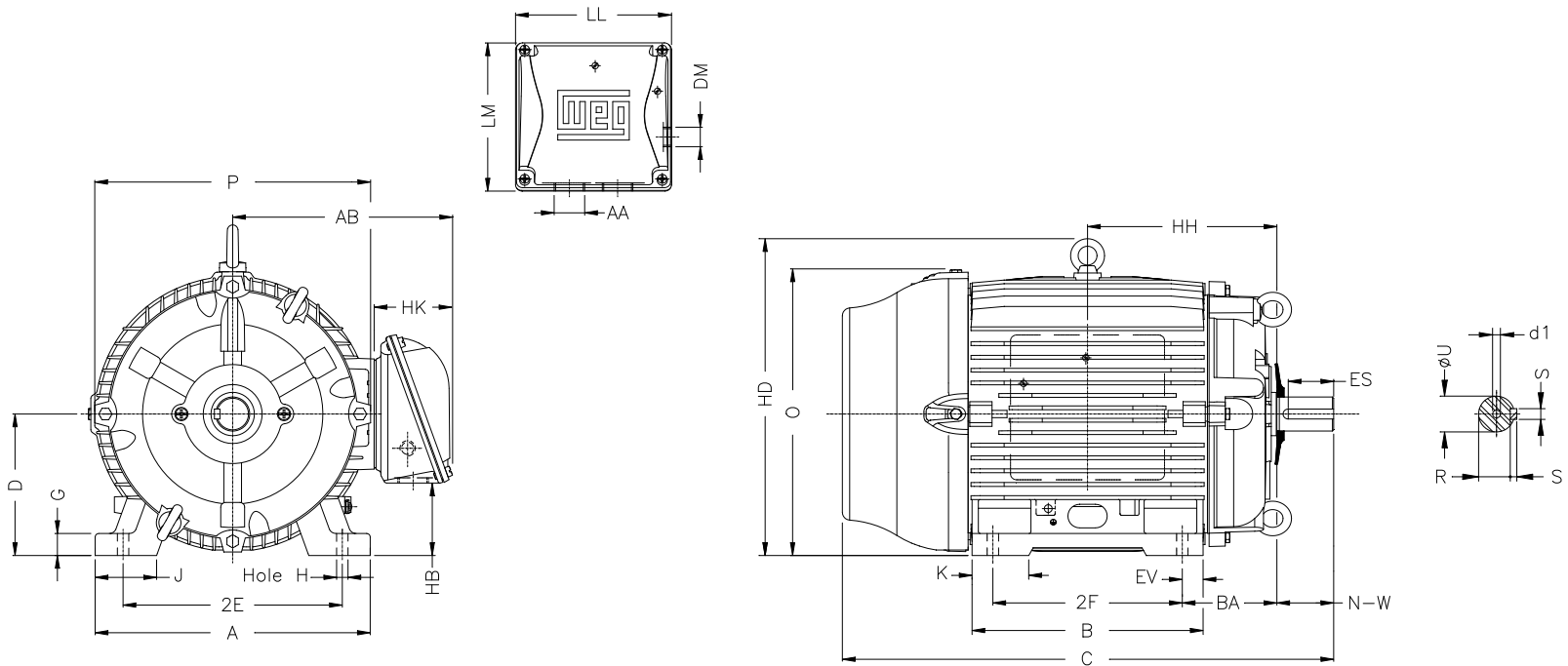

Notes:

2E 11.000	J 3.110	A 13.780	P 13.780	AB 11.073
2F 11.000	K 2.874	B 13.071	BA 4.750	U 1.875
N-W 4.622	ES 3.149	S 0.500	R 1.594	depth 0.500
D 7.000	G 1.023	HB 3.535	O 14.067	T 2.087
HD 16.154	HF 7.000	HH 10.250	HK 3.987	H 0.531
C 27.929	LL 7.813	LM 7.482	AA NPT 1 1/2"	d1 A 4
d2 A 4				

Performed by:

Checked:

Customer:

W22 Cooling Tower Motors: NEMA Premium

Three-phase induction motor
Frame 286T - IP55

31-DEC-2012

