



No.:

Date: 31-DEC-2012

Customer :

TECHNICAL PROPOSAL

Three-phase induction motor - Squirrel cage rotor

Product line : W22 Cooling Tower Motors: NEMA Premium

Catalog Number : 05012ET3ECT365T-W22

List Price : \$9,625

Notes:

Performed by:

Checked:



No.:

Date: 31-DEC-2012

## DATA SHEET

### Three-phase induction motor - Squirrel cage rotor

Customer :  
Product line : W22 Cooling Tower Motors: NEMA Premium

Frame : 364/5T  
Output : 50 HP  
Frequency : 60 Hz  
Poles : 6  
Full load speed : 1180  
Slip : 1.67 %  
Voltage : 208-230/460 V  
Rated current : 127-115/57.4 A  
Locked rotor current : 735/367 A  
Locked rotor current (I<sub>L</sub>/I<sub>n</sub>) : 6.4  
No-load current : 40.0/20.0 A  
Full load torque : 220 lb.ft  
Locked rotor torque : 200 %  
Breakdown torque : 240 %  
Design : B  
Insulation class : F  
Temperature rise : 80 K  
Locked rotor time : 18 s (hot)  
Service factor : 1.25  
Duty cycle : S1  
Ambient temperature : -20°C - +40°C  
Altitude : 1000  
Degree of Protection : IP55  
Approximate weight : 869 lb  
Moment of inertia : 32.391 sq.ft.lb  
Noise level : 66 dB(A)

	D.E.	N.D.E.	Load	Power factor	Efficiency (%)
Bearings	6314 C3	6314 C3	100%	0.86	94.1
Regreasing interval	17000 h	17000 h	75%	0.83	94.1
Grease amount	27 g	27 g	50%	0.74	93.6

Notes:

Performed by

Checked



No.:

Date: 31-DEC-2012

### PERFORMANCE CURVES RELATED TO RATED OUTPUT

Three-phase induction motor - Squirrel cage rotor

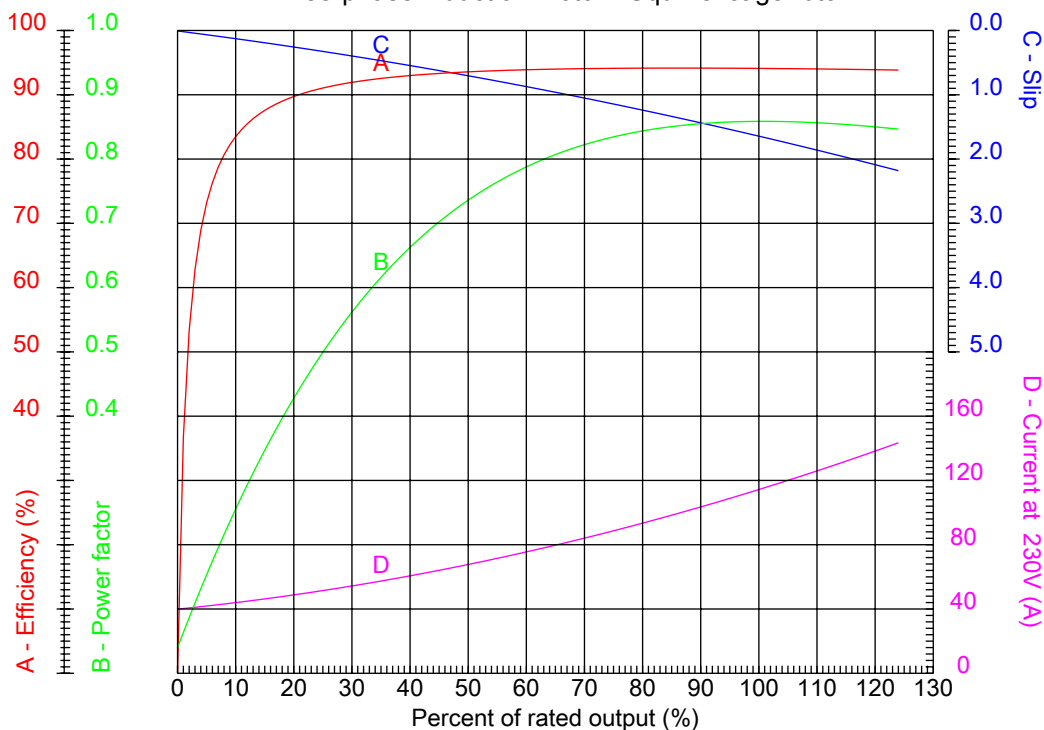

Customer :  
Product line : W22 Cooling Tower Motors: NEMA Premium

Frame	: 364/5T	Locked rotor current (I <sub>l</sub> /I <sub>n</sub> )	: 6.4
Output	: 50 HP	Duty cycle	: S1
Frequency	: 60 Hz	Service factor	: 1.25
Full load speed	: 1180	Design	: B
Voltage	: 208-230/460 V	Locked rotor torque	: 200 %
Rated current	: 127-115/57.4 A	Breakdown torque	: 240 %
Insulation class	: F		

Notes:

Performed by

Checked



No.:

Date: 31-DEC-2012

### CHARACTERISTIC CURVES RELATED TO SPEED

Three-phase induction motor - Squirrel cage rotor

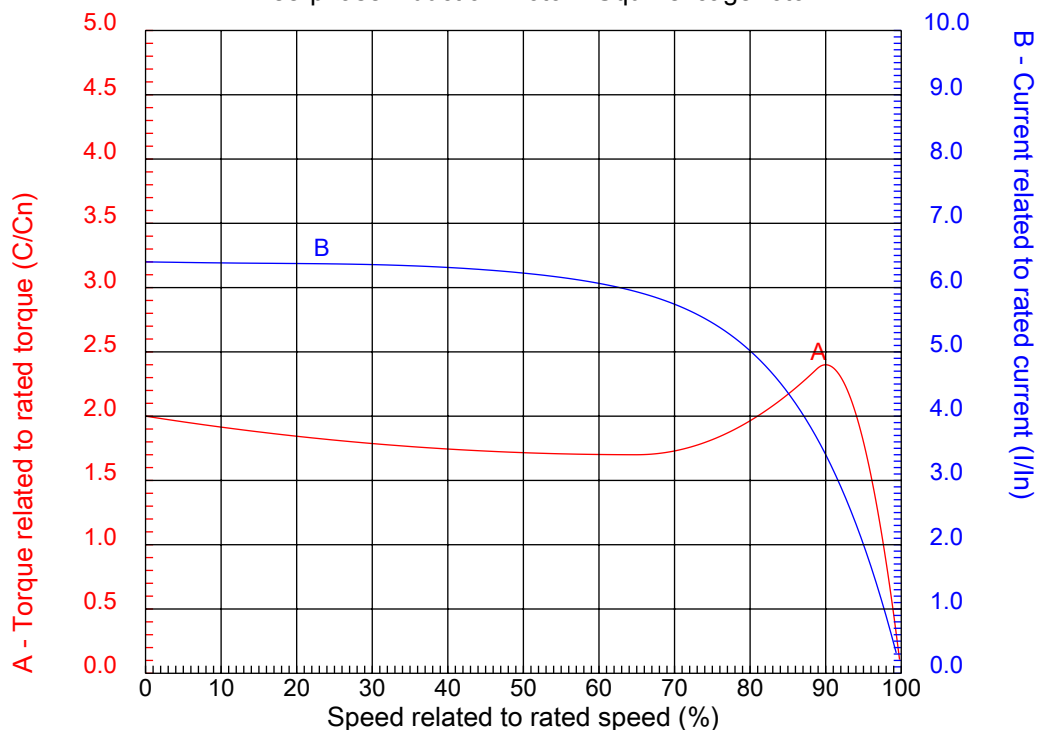

Customer :  
Product line : W22 Cooling Tower Motors: NEMA Premium

Frame	: 364/5T	Locked rotor current (I <sub>l</sub> /I <sub>n</sub> )	: 6.4
Output	: 50 HP	Duty cycle	: S1
Frequency	: 60 Hz	Service factor	: 1.25
Full load speed	: 1180	Design	: B
Voltage	: 208-230/460 V	Locked rotor torque	: 200 %
Rated current	: 127-115/57.4 A	Breakdown torque	: 240 %
Insulation class	: F		

Notes:

Performed by

Checked

1 2 3 4 5 6 7 8

A

B

C

D

E

F

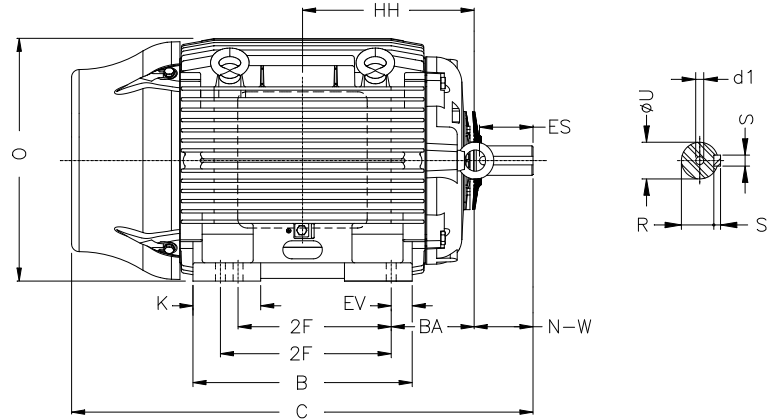
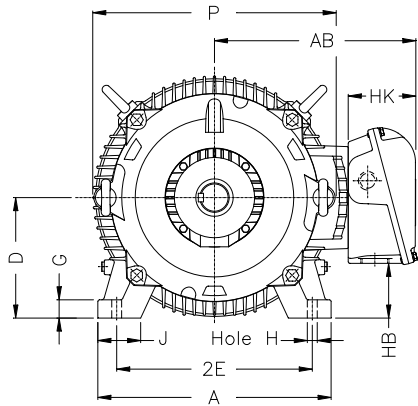
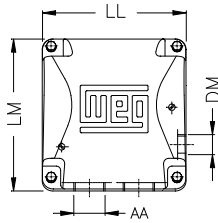

Notes:

Performed by:

Checked:

Customer:

W22 Cooling Tower Motors: NEMA Premium

Three-phase induction motor  
Frame 364/5T - IP55

31-DEC-2012



2E 14.016	J 3.150	A 17.165	P 17.914	AB 15.997
2F 11.260/12.244	K 4.921	B 15.760	BA 5.875	U 2.375
N-W 5.874	ES 4.330	S 0.625	R 2.019	depth 0.625
D 9.000	G 1.480	HB 4.055	O 17.957	T 3.578
HD 21.535	HH 12.362	HK 5.997	H 0.660	C 34.251
LL 10.591	LM 11.266	AA NPT 3"	d1 DUNC 3/4"-10	d2 DUNC 3/4"-10