

# INSTALLATION AND MAINTENANCE



## KBP1230 Garage/Shop Unit Heater



SPECIFICATIONS	
Watts	2850W
Heating Area (ft <sup>2</sup> )	300 ft <sup>2</sup>
Power (Volts)	120 V
Amps	24 A
Switch	Heat/Fan/Off
Thermostat	40° F—90° F

DANGER

**ELECTRIC SHOCK OR FIRE HAZARD**

READ ALL WIRE SIZING, VOLTAGE REQUIREMENTS AND SAFETY DATA TO AVOID PROPERTY DAMAGE AND PERSONAL INJURY

The **KBP1230** unit heater is to be operated at **120 volts**. It is important that you verify the power supply voltage is the same as the nameplate voltage of the heater. Connecting the heater to an improper voltage of failure to follow the procedures as outlined in this manual can result in damage to the heater and void the warranty. This heater is provided with a factory installed thermostat. Disconnect all power from the heater at the main service panel before attempting to install or service this unit. All electrical wiring must conform to local electrical codes. Heater circuit must be properly protected.

WARNING

**READ CAREFULLY** - Use the heater only as described in this manual. Any other use is not recommended and could result in fire, electric shock, and personal injury. Following these instructions will prevent difficulties that might occur during the installation and use of the heater. Please study the instructions first, as they may save considerable time and trouble during use addition to providing important safety information. Make sure to save these instructions for future use.

Read all instructions before wiring or using this heater.

- WARNING** Heaters outlet grill is very hot when in use. To avoid burns, do not touch hot surfaces with bare skin. Keep combustible materials, including furniture, pillows, bedding, papers, clothes, curtains, and boxes at least 3 feet from the front of the heater and keep them away from the sides and rear.
- WARNING** Do not use outdoors.
- WARNING** Heater is not intended for use in bathrooms, laundry areas or similar indoor locations. Never locate heater where it may fall into a bathtub or other water container.
- WARNING** Do not insert or allow foreign objects to enter any inlet or outlet openings as this may cause an electric shock, fire, or damage to the heater.
- WARNING** To prevent a possible of fire, do not block air intakes or exhaust in any manner.
- WARNING** Heater has hot surfaces. Internal thermostat and limiting parts will arcing or create sparks inside. Do not use this heater in areas where gasoline, paint, or flammable liquids or gases are used or stored.
- WARNING** Use this heater only as described in this manual. Any other use is not recommended by the manufacturer and my cause fire, electric shock, explosion or injury to people and or property.
- WARNING** If heater shows signs of overheating immediately turn the circuit breaker off to the heater. Remove and inspect for any objects on or adjacent to the heater that may cause the high temperatures. Have a professional inspect the internals until the reason is clear why the heater is overheating. Do not reinstall until it has been professionally serviced.
- WARNING** Do not operate heater after it malfunctions. Disconnect heater at service panel and have heater inspected by a reputable electrician before reusing. To disconnect heater, turn controls to off position, and turn off power to heater circuit at main electrical panel or operate internal disconnect switch to off if provided.
- WARNING** Extreme caution is necessary when any heater is used by or near children or invalids and whenever the heater is left operating and unattended too.

# SAFETY INFORMATION



!

DANGER

---

ELECTRIC SHOCK OR FIRE HAZARD

READ ALL WIRE SIZING, VOLTAGE REQUIREMENTS AND SAFETY DATA TO AVOID PROPERTY DAMAGE AND PERSONAL INJURY



Minimum Clearance From Combustibles	
Front	18 in.
Top	2 in.
Sides	6 in.
Rear	5 in.



**Warning:** Prior to operating, make sure the circuit breaker is of the configuration and capacity appropriate for the heater.

- Use extreme caution when heater is used near children or people with disabilities
- Do not use outdoors.
- Not intended for use in bathrooms, laundry areas or other similar wet locations. Never locate heater where it may have contact with water.
- Do not use heater in wet or moist locations
- Do not place the heater against cardboard or low-density fiberboard surfaces.
- Avoid using an extension cord because the extension cord may overheat and cause a risk of fire.
- Use only the electrical power (voltage and frequency) specified on the model plate of the heater.
- Keep all combustible materials away from this heater

## WHAT'S IN THE BOX

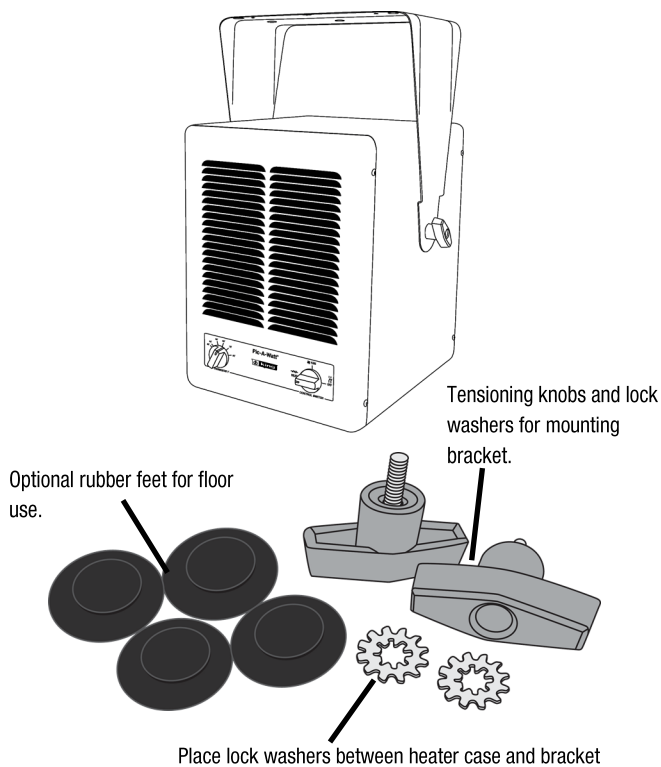

## HEATER DIAGRAM

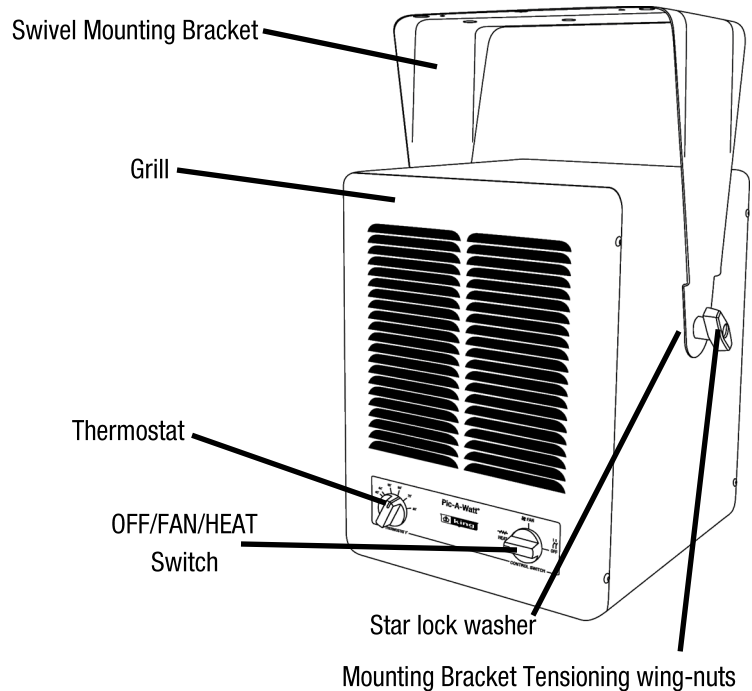

# ASSEMBLY INSTRUCTIONS



## KBP1230 Garage/Shop Unit Heater

Figure 1

Minimum Clearance From Combustibles	
Front	18 in.
Top	2 in.
Sides	6 in.
Rear	5 in.



**DANGER**

**ELECTRIC SHOCK OR FIRE HAZARD**

READ ALL WIRE SIZING, VOLTAGE REQUIREMENTS AND SAFETY DATA TO AVOID PROPERTY DAMAGE AND PERSONAL INJURY

### INSTALLATION INSTRUCTIONS

#### FOR WALL MOUNT APPLICATIONS

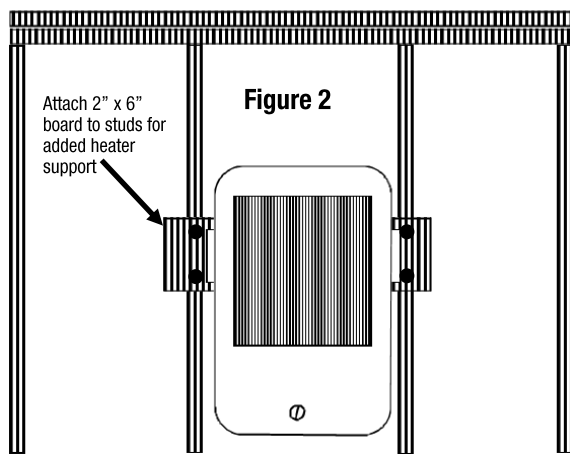

#### FOR CEILING MOUNT APPLICATIONS

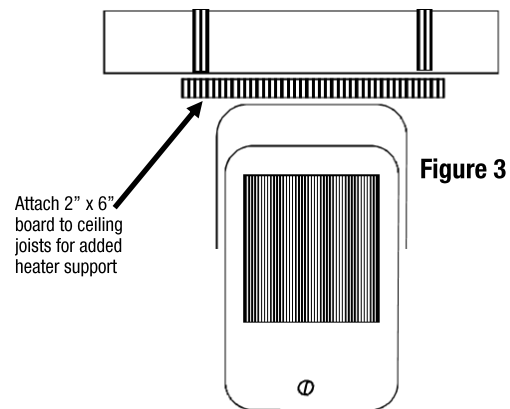

#### TOOLS NEEDED:

- Screwdriver (Phillips & Slotted)
- Wire Cutters
- Pliers
- Adjustable Wrench
- Electric Drill

Remove heater & all packaging materials from the box.

#### HARDWARE NEEDED:

- Adequate gauge & length of wire for your application
- Proper size fuses or breakers to handle amperage
- Proper wire connectors for your application
- Fasteners appropriate size to mount heater



**Tip: Be sure to remove the hardware package from the Styrofoam packaging.**

#### MOUNTING HEIGHT:

When the air flow of the heater is directed vertically or horizontally, the minimum mounting height is 6 feet in the USA and 8 feet in Canada. Mounting heights depend upon building utilization and heater KW capacity.

#### LOCATION OF HEATER:

The heater should be installed out of the reach of persons and according to minimum clearance chart (Figure 1) The direction of airflow should not be restricted by machinery, beams, etc., and the air flow should run with walls, rather than blowing directly at them. When more than one heater is used in an area, the heaters should be arranged so that the air discharge of each heater supports the air flow of the others to provide best circulation of warm air. (see figure 4).

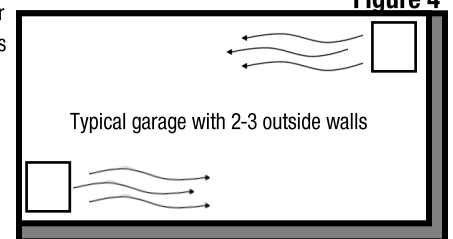

#### MOUNTING HEATER:

Wall stud and ceiling joists are typically wider than our mounting bracket which is 11 inches wide. The heater weighs 14 lbs. and should be mounted onto at least one stud to be properly supported.

Your fasteners penetrating a stud is critical to supporting the weight. A gypsum wall board fastener is not strong enough. But if your ideal location has no solid backing, you can fasten with large screw fasteners a 2" x 6" board to ceiling joists or wall studs. Attach with appropriate lag bolts with proper depth for the 14 lbs. Install wing nut fasteners into the outside of the bracket and star washer between the heater and bracket. Be certain adjustment knobs are tightened firmly to secure the heater to swivel bracket.

# INSTALLATION INSTRUCTIONS

**WARNING** Before proceeding further with the installation of this heater, turn off the power and lock the supply line for the heater at the main service box.

**WIRING HEATER:**

1. Remove wiring compartment cover.
2. Remove one of the knock outs from the back of the unit. It is not necessary to remove the grill cover.
3. Size service wire to adequately handle amp load of the heater. Refer to the Circuit Sizing Table for proper wire size and circuit protection.
4. Connect supply wire to L1 & L2 as shown in the diagram below.
5. Secure power supply cable with cable clamp.
6. Connect ground wire to the green pig tail.
7. Adjust the heater to the desired position.

Watts (Max)	Volts	Amps	Wire Size	Circuit Protection
1440	120	12	#14/2	15A-1P
1920	120	16	#12/2	20A-1P
2850	120	24	#10/2	30A-1P

Per the National Electrical Code heating circuits are considered a continuous load and therefore must be derated by 20%. For example a 20 amp heating circuit can not have more than 16 amps of connected load.

Note: Power must land at heater uninterrupted by switches or thermostat due to thermal fan delay

## WIRING DIAGRAM

**Pic-A-Watt® Heating Element** Exclusive king multi-tap element allows field adjustment to several wattages at time of installation.

**Field Wattage Selection**

1. Heater is wired at 2850 watts (Maximum Wattage)
- A. Disconnect A to reduce total wattage by 712 watts
- B. Disconnect B to reduce total wattage by 238 watts
- C. Disconnect C to reduce total wattage by 712 watts
- D. Disconnect D to reduce total wattage by 238 watts
- E. Black Do Not Disconnect (Common)**
- F. Red Do Not Disconnect**

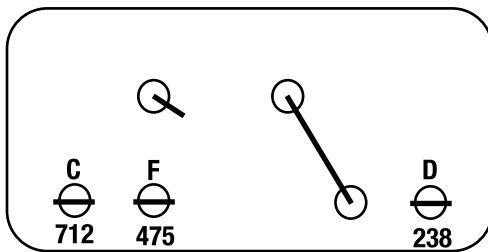
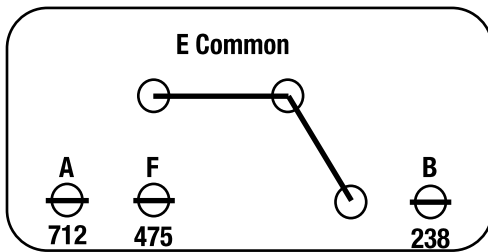

END VIEW OF ELEMENT

SHOWING QUICK CONNECT TERMINALS

975 • 1426 • 1900 • 2374 • 2850

WATTAGES AVAILABLE IN ONE UNIT

**KBP1230 120 Volt 2850 Watt**

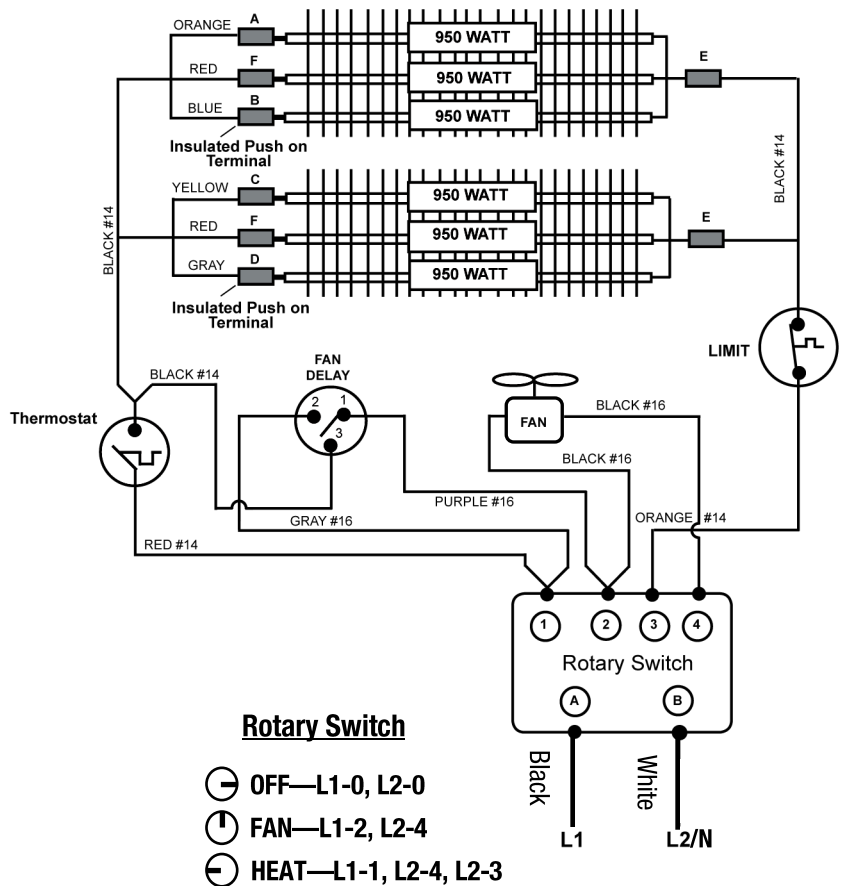

**Rotary Switch**

- ⊖ OFF—L1-0, L2-0
- ⌚ FAN—L1-2, L2-4
- ⊕ HEAT—L1-1, L2-4, L2-3



# TROUBLESHOOTING



## KBP1230 Garage/Shop Unit Heater



Dimensions	
Height	13-1/2"
Width	10"
Depth	11-1/2"
With Bracket	
From wall	16-1/2"
From ceiling	18-1/2"

DANGER

ELECTRIC SHOCK OR FIRE HAZARD

READ ALL WIRE SIZING, VOLTAGE REQUIREMENTS AND SAFETY DATA TO  
AVOID PROPERTY DAMAGE AND PERSONAL INJURY



## MAINTANANCE AND WARRANTY

The high quality and superior design of the Pic-a-Watt heater will provide years of trouble free performance. Each year the heater should be checked and cleaned for lint and dust accumulation. We recommend using a soft bristled brush such as a paint brush to assist in removing contaminants from the heater. The motor is permanently lubricated and does not need servicing. King Electrical Mfg. Co. will repair or replace, with out charge any KBP1230 heater found to be defective or malfunctioning for five years after purchase to the original owner. For a warranty claim call King at 1-800-603-5464, do not take the heater back to the store purchased from.

## TROUBLESHOOTING GUIDE

Problem	Cause	Solution
Fan stays on when heat shuts off	Fan delay cycles ON/OFF until elements are cool	Heater is operating correctly
Heating element does not glow red	Heating element is made of stainless steel and will not glow red to produce heat	Heater is operating correctly
Do not feel heat or air flow	No power to heater	Check power connections/connect heater to power supply
	Desired room temperature is reached	Thermostat will shut off once desired room temperature is reached. Heater is operating correctly
	Heater does not heat area in front of heater, it will disperse heat throughout room to heat entire space	Heater is operating correctly
Oil drip from heater	Over fill of oil reservoir in motor or angle of heater is too extreme	Will stop once over fill is purged. Reduce angle of heater to level.