

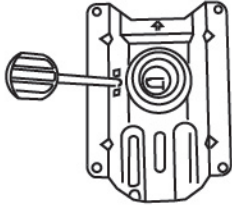

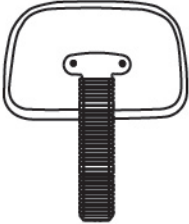

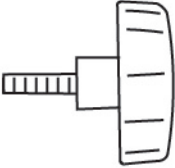

**IMPORTANT NOTICE:  
HARDWARE PACKAGE IS ATTACHED  
ON THE BOTTOM OF SEAT CUSHION.**

MODEL: 16245

(1)x1	(2)x1	(3)x1
		
Seat Cushion	TU001-305/Mechanism	Back Cushion W/ Back Support & Bellow
(4)x1	(5)x1	(6)x1
		
TU305-Knob/Knob	TU026-240/5 / Gas Lift	TU005-240/5 / Base
(7)x1	(8)x1	(9)x5
		
TU009	TU009-EXT	TU015 / Casters
(A)x4	M8X22 MECHANISM SCREW	
		

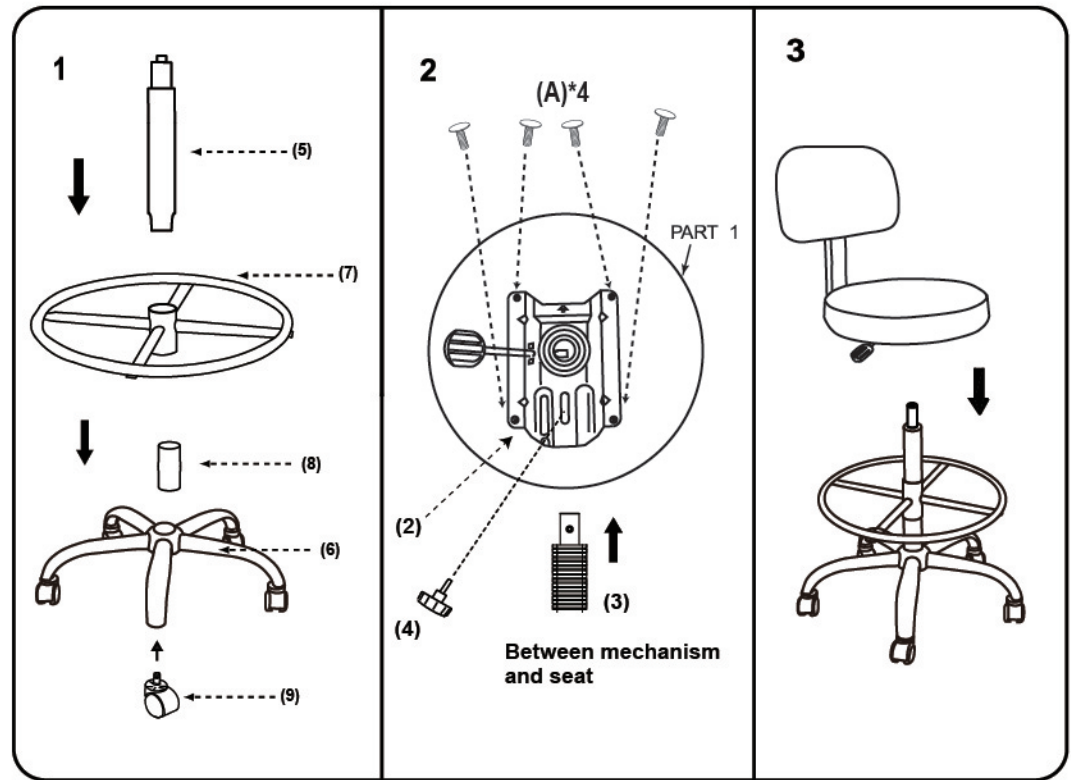

**Insert and loosely tighten all screws. When assembly is completed, fully tighten all screws before using. This chair is only intended for sitting. Any other use will void the warranty.**

