

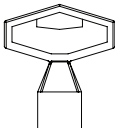

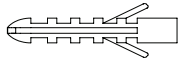

Part # PP-DSP-2R400

Please verify the following contents:

	X 1		X 4
	X 4		X 4
			X 2 For Pet Station Assembly

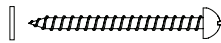
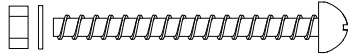
For Poopy Pouch Pet Station channel post assembly, please use the installation and specification sheet on the reverse side.

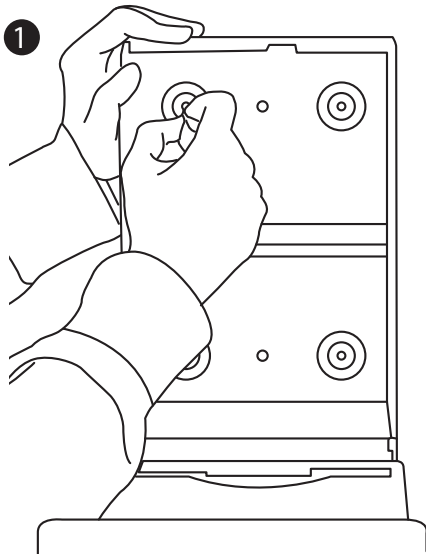

Position the dispenser against the desired spot on the wall where it will be mounted. Use a marker to mark the position of the outside four holes where the holes should be drilled. A spirit level should be used to make sure the dispenser hangs straight.

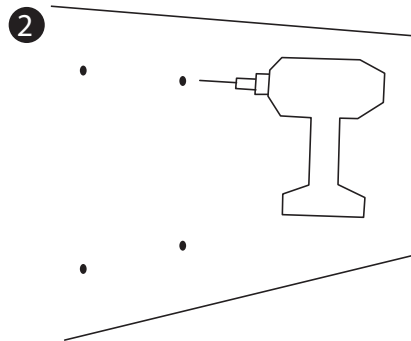

Drill the holes with a 6mm drill bit, a minimum of 1" inch deep.

! Be cautious of cables or pipes in the area when drilling holes!

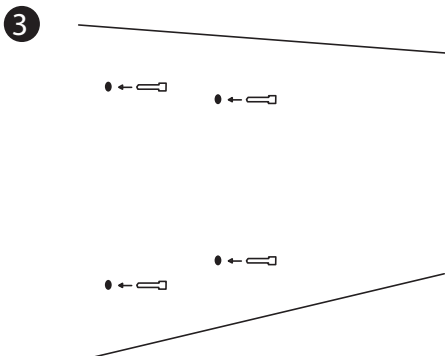

Insert the provided plastic anchors into the drilled holes.

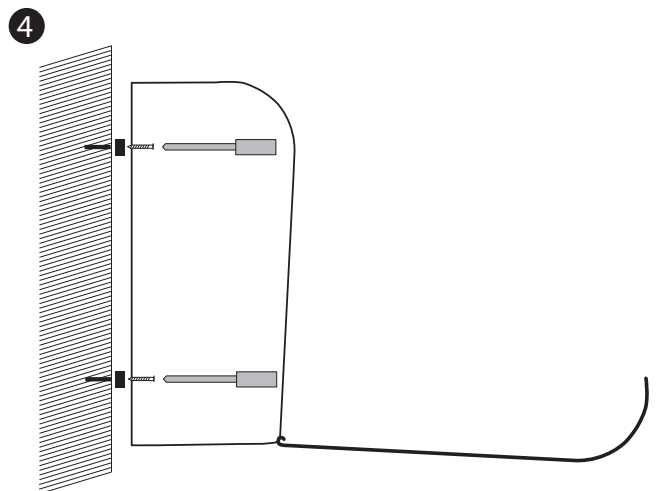

Insert the provided 1.4" inch screws through the dispenser into the provided black rubber distance holders which are placed between the wall and dispenser. Screw the dispenser into position.



SPECIFICATION AND INSTALLATION SHEET

 **CrownProducts**
www.crownproductsonline.com

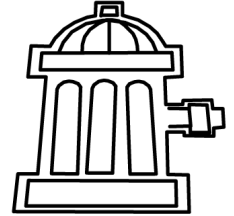

POOPY POUCH DISPENSER, RECEPTACLE WITH SIGN AND POST

