



No.:

Date: 19-DEC-2012

Customer :

TECHNICAL PROPOSAL

Three-phase induction motor - Squirrel cage rotor

Product line : Three-Phase : ODP (IP21/IP23) - NEMA Premium Efficiency

Catalog Number : 02036OT3E254T

List Price : \$1,760

Notes:

Performed by:

Checked:



No.:

Date: 19-DEC-2012

DATA SHEET

Three-phase induction motor - Squirrel cage rotor

Customer :
Product line : Three-Phase : ODP (IP21/IP23) - NEMA Premium Efficiency

Frame : 254T
Output : 20 HP
Frequency : 60 Hz
Poles : 2
Full load speed : 3520
Slip : 2.22 %
Voltage : 208-230/460 V
Rated current : 54.4-49.2/24.6 A
Locked rotor current : 295/148 A
Locked rotor current (I_L/I_n) : 6.0
No-load current : 19.0/9.50 A
Full load torque : 29.4 lb.ft
Locked rotor torque : 190 %
Breakdown torque : 250 %
Design : B
Insulation class : F
Temperature rise : 80 K
Locked rotor time : 12 s (hot)
Service factor : 1.15
Duty cycle : S1
Ambient temperature : -20°C - +40°C
Altitude : 1000
Degree of Protection : IP23
Approximate weight : 203 lb
Moment of inertia : 0.73278 sq.ft.lb
Noise level : 66 dB(A)

	D.E.	N.D.E.	Load	Power factor	Efficiency (%)
Bearings	6309 Z-C3	6209 Z-C3	100%	0.84	91.0
Regreasing interval	20000 h	20000 h	75%	0.80	90.2
Grease amount	13 g	9 g	50%	0.71	89.5

Notes:

Performed by

Checked



No.:

Date: 19-DEC-2012

PERFORMANCE CURVES RELATED TO RATED OUTPUT
Three-phase induction motor - Squirrel cage rotor

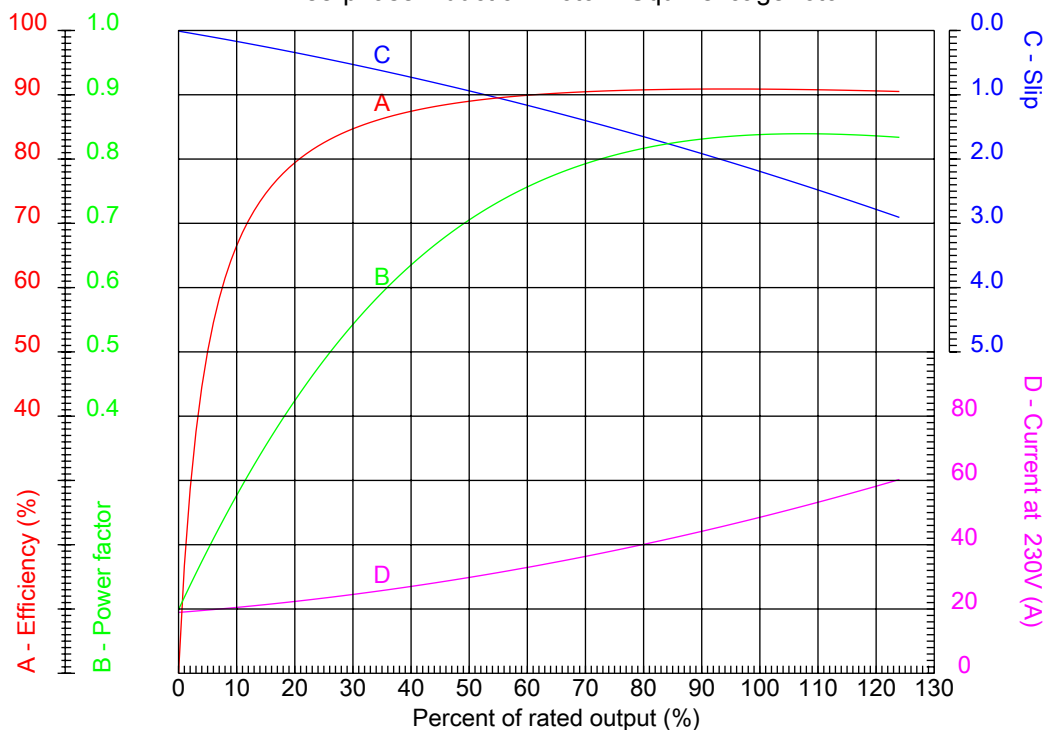

Customer :
Product line : Three-Phase : ODP (IP21/IP23) - NEMA Premium Efficiency

Frame	: 254T	Locked rotor current (I _l /I _n)	: 6.0
Output	: 20 HP	Duty cycle	: S1
Frequency	: 60 Hz	Service factor	: 1.15
Full load speed	: 3520	Design	: B
Voltage	: 208-230/460 V	Locked rotor torque	: 190 %
Rated current	: 54.4-49.2/24.6 A	Breakdown torque	: 250 %
Insulation class	: F		

Notes:

Performed by

Checked



No.:

Date: 19-DEC-2012

CHARACTERISTIC CURVES RELATED TO SPEED Three-phase induction motor - Squirrel cage rotor

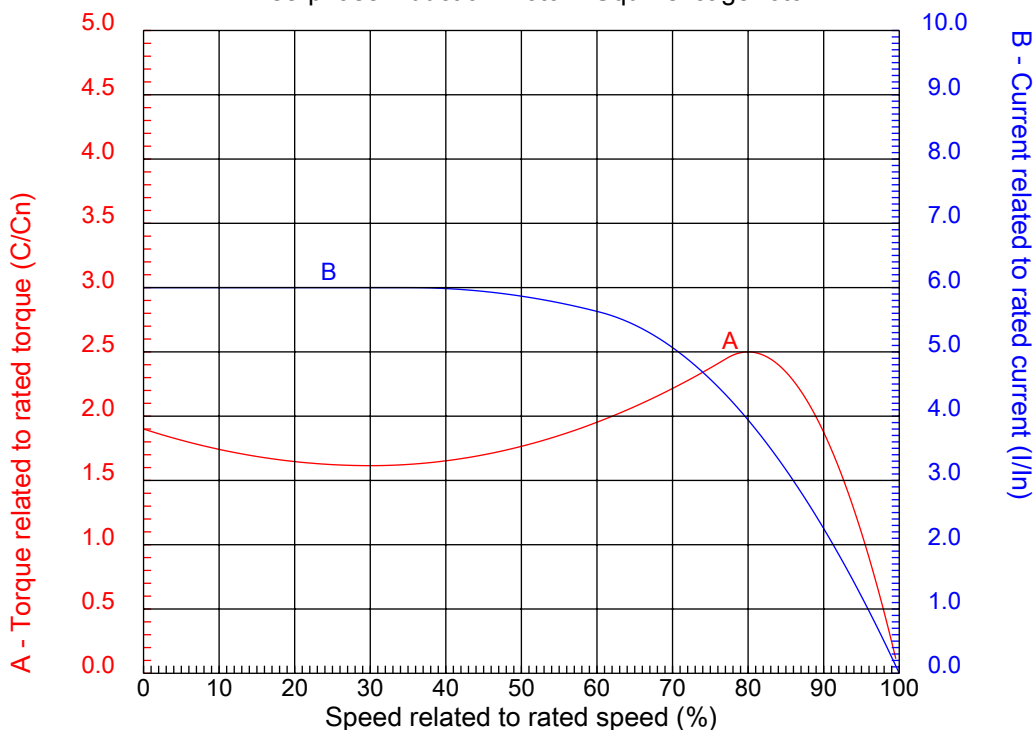

Customer :
Product line : Three-Phase : ODP (IP21/IP23) - NEMA Premium Efficiency

Frame	: 254T	Locked rotor current (I _l /I _{ln})	: 6.0
Output	: 20 HP	Duty cycle	: S1
Frequency	: 60 Hz	Service factor	: 1.15
Full load speed	: 3520	Design	: B
Voltage	: 208-230/460 V	Locked rotor torque	: 190 %
Rated current	: 54.4-49.2/24.6 A	Breakdown torque	: 250 %
Insulation class	: F		

Notes:

Performed by

Checked

1 2 3 4 5 6 7 8

A

B

C

D

E

F

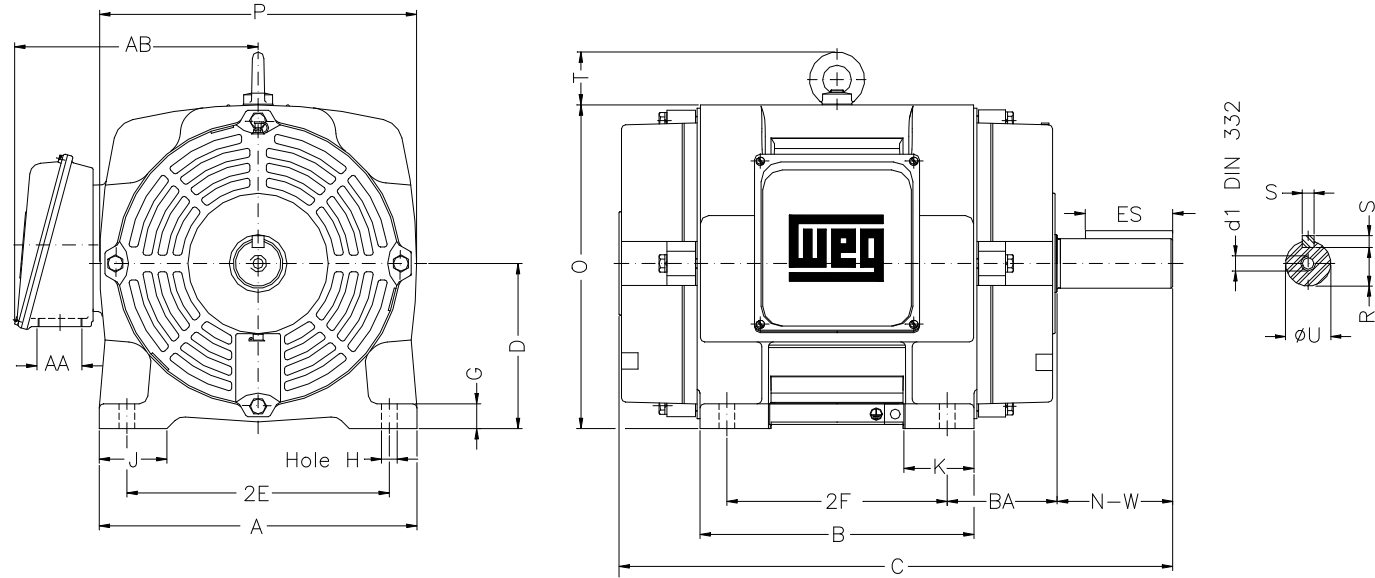

Notes:

2E 10.000	A 12.130	2F 8.250	B 10.100	BA 4.250
J 2.520	K 2.560	P 11.812	ES 2.756	depth 0.375
S 0.375	D 6.250	N-W 4.000	G 0.787	U 1.625
O 12.204	T 2.165	HD 14.369	R 1.406	H 0.531
AB 10.079	C 20.669	AA NPT 1 1/2"	d1 A 4	d2 A 4
Flange FD-317	AJ 12.500	AK 11.000	BD 14.000	BF 0.828
BB 0.250				

Performed by:

Checked:

Customer:

Three-Phase : ODP (IP21/IP23) - NEMA Premium Efficiency

Three-phase induction motor
Frame 254T - IP23

19-DEC-2012

