

SECTION B-B

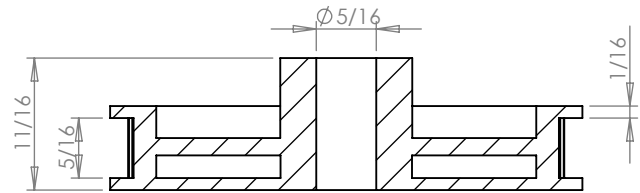
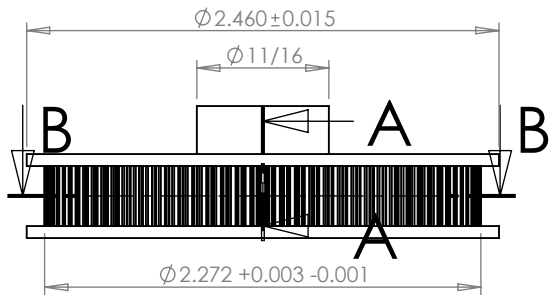
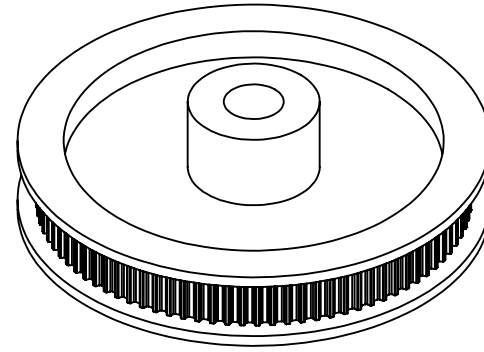

SECTION A-A

**PLASTOCK**®  
 Manufactured by Putnam Precision Molding

Part Number:  
**90T0800DF**

www.plastock.biz  
 © 2010 Putnam Precision Molding

Part Description:  
 .0800" Pitch (MXL) Timing Belt  
 Pulleys For Belts up to 1/4" Wide

Dimensions are in inches  
 Tolerances:  
 Fractional ± 0.015

**PROPRIETARY AND CONFIDENTIAL :** THE INFORMATION CONTAINED IN THIS DRAWING IS THE SOLE PROPERTY OF PUTNAM PRECISION MOLDING. ANY REPRODUCTION IN PART OR AS A WHOLE WITHOUT THE WRITTEN PERMISSION OF PUTNAM PRECISION MOLDING IS PROHIBITED. INFORMATION IN THIS DRAWING IS PROVIDED FOR REFERENCE ONLY.